

# Looking Back ...

- Design patterns for HCI
  - Name, problem, solution, discussion
  - Appear as , e.g., task, user, UI element, UI arrangement, interaction style, organisational patterns
- Visual design patterns
- Interaction methods
- Interaction metaphors
- Prototyping

# Mensch-Maschine-Interaktion 1

Chapter 5 (July 1, 2010, 9am-12pm):  
Capabilities of Humans and Machines

# Capabilities of Humans and Machines

- Designing Systems for Humans
- Senses and Sensing
- Cognitive Abilities and Memory
- Hardware Technologies for Interaction
- Natural and Intuitive Interaction, Affordances

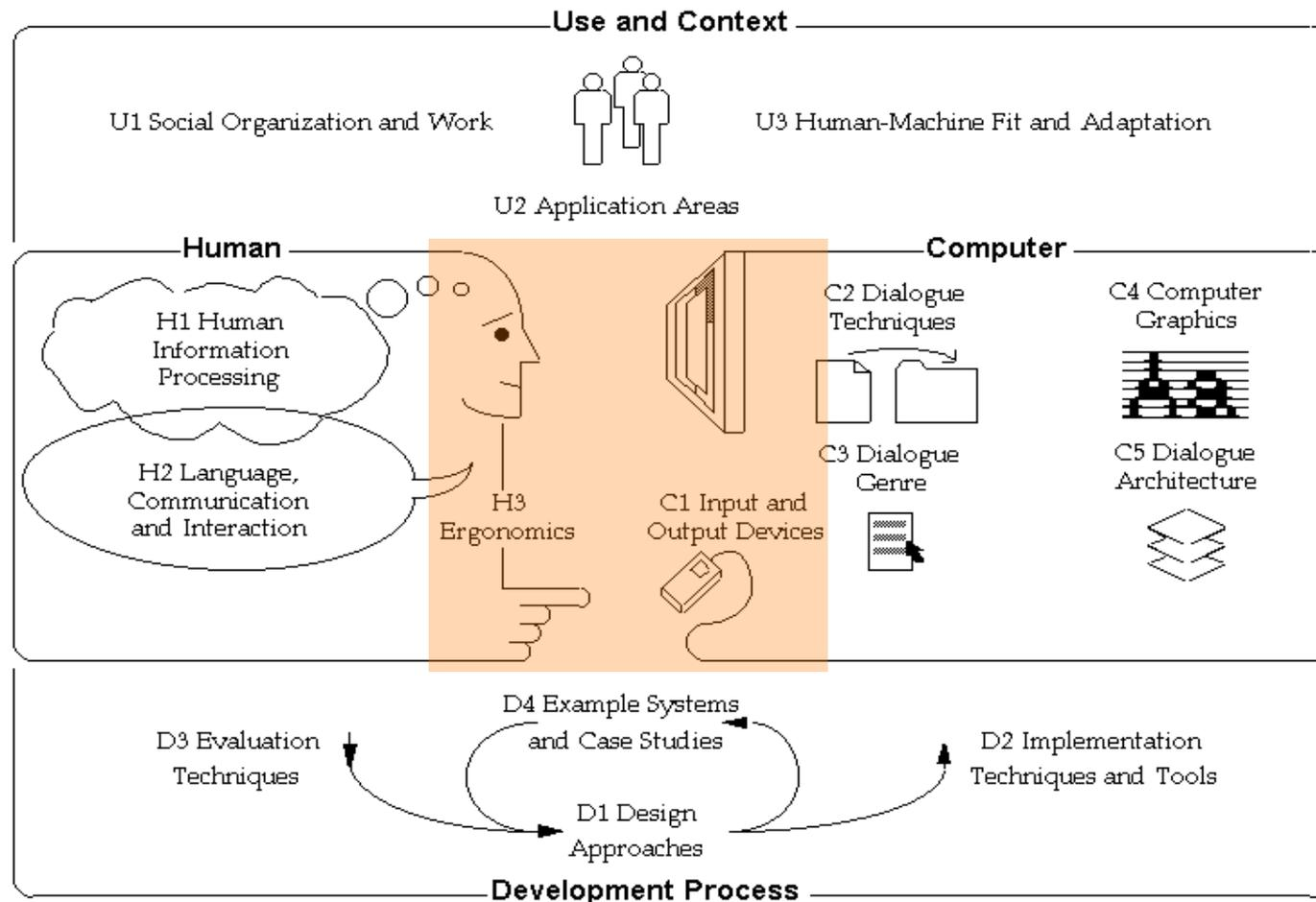

What are the prerequisites on the human side?

What is offered by the machine side?

# Designing for humans

## What has to be considered?

- Humans are very complex! Even psychology only explains parts...
- Physiology (e.g. size, strength, degrees of freedom, fatigue)
- Psychology (e.g. memory, perception, cognition)
- Variety (e.g. gender, abilities and disabilities)
- Soft factors (e.g. aesthetics, motivation, pleasure, experience) related to psychology and physiology

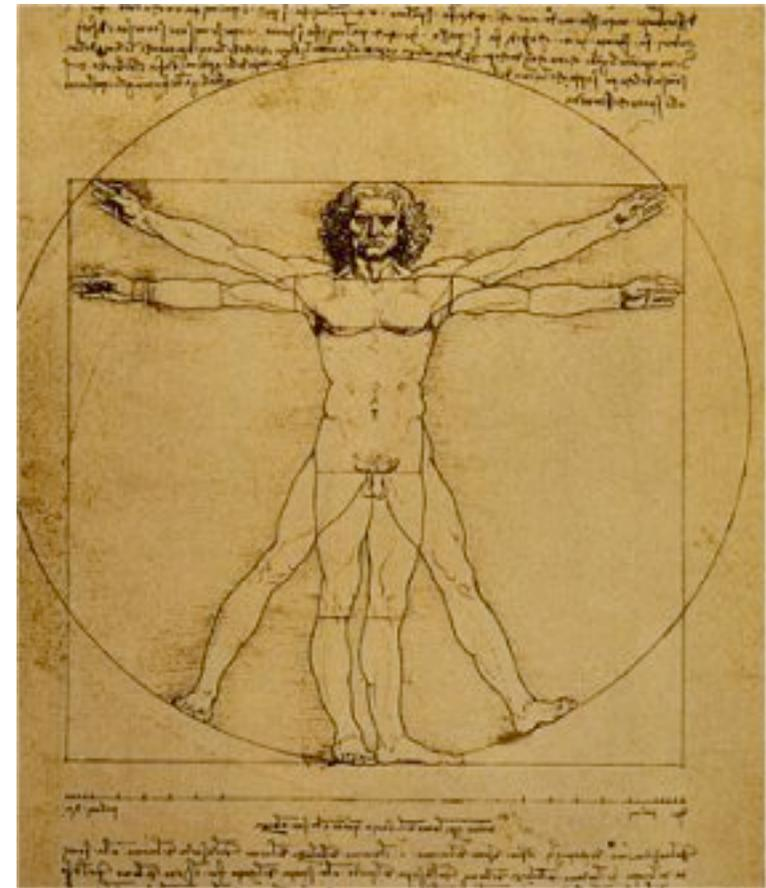

# Human Abilities

- Abilities of un-augmented users in general do not change a lot over time, e.g.
  - ability to cope with cognitive load
  - willingness to cope with stress
  - time one can concentrate on a particular problem
- Abilities between individual users vary a lot
  - long term, e.g. gender, physical and intellectual abilities
  - short term, e.g. effect of stress or fatigue
- Abilities of one individual users changes over time (e.g. getting old)

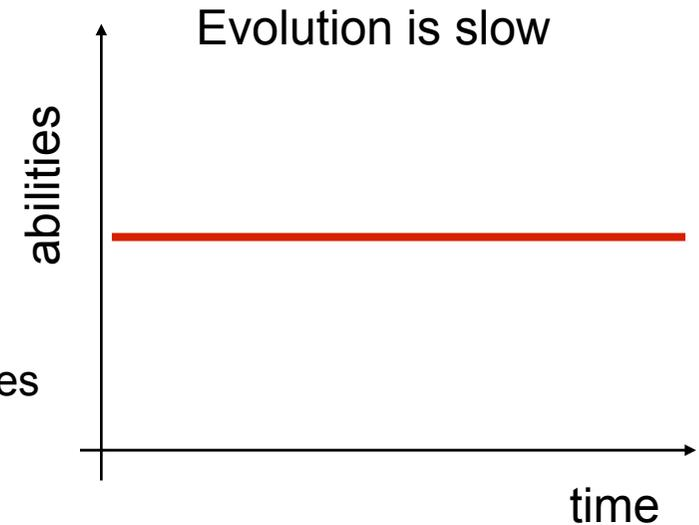

# Physiology

- Examples
  - Size of objects one can grasp
  - Weight one can lift or hold
  - Reach while seated or while standing
  - Optical resolution of the human vision system
  - Frequencies humans can hear
  - Conditions people can live in
  - ...
- How does this relate to computer science?
  - Device and systems that are built
  - Processes we expect humans to perform
- If we ignore it...
  - People may not be able to use it
  - Performance will be suboptimal



# Discussion

## Gesture Input vs. Physiology?



From the movie Minority Report  
<http://www.minorityreport.com/>



From the movie Iron Man



# Capabilities of Humans and Machines

- Designing Systems for Humans
- Senses and Sensing
- Cognitive Abilities and Memory
- Hardware Technologies for Interaction
- Natural and Intuitive Interaction, Affordances

# The Human Eye

- See *Digitale Medien*
- Basics
  - Very high dynamic range
  - Bad color vision in dark conditions
  - Best contrast perception in red/green
  - Limited temporal resolution (reaction speed)
  - Good resolution and color in central area (macula)
  - Maximum resolution and color only in the very center (fovea)
    - » eye does not see the full picture but scans the scene by jumping from detail to detail

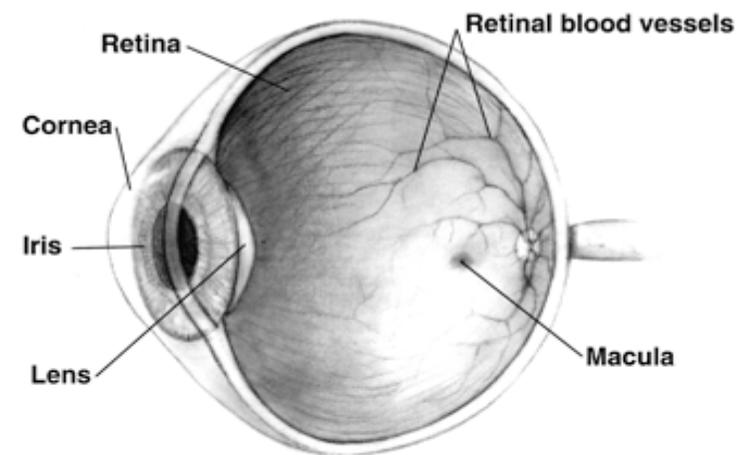

Images from wikipedia

# Reception and Interpretation

## Two stages in vision

- physical reception of stimulus
- processing and interpretation of stimulus

## Interpreting the signal

- Size and depth
  - visual angle indicates how much of view object occupies
  - visual acuity is ability to perceive detail (limited)
  - familiar objects perceived as constant size
  - cues like overlapping help perception of size and depth
- Brightness, Colour
  - visual acuity increases with luminance as does flicker
  - blue acuity is lowest
  - 8% males and 1% females colour blind
- The visual system compensates (e.g. for movement, changes in luminance)
  - Context is used to resolve ambiguity
  - Optical illusions sometimes occur due to overcompensation

# Eye movement



- Eye movement can be visually detected and used for eye-tracking
- You can tell where someone looks

# Eye Tracking

<http://www.smashingmagazine.com/images/usability-glossary/tracking.jpg>

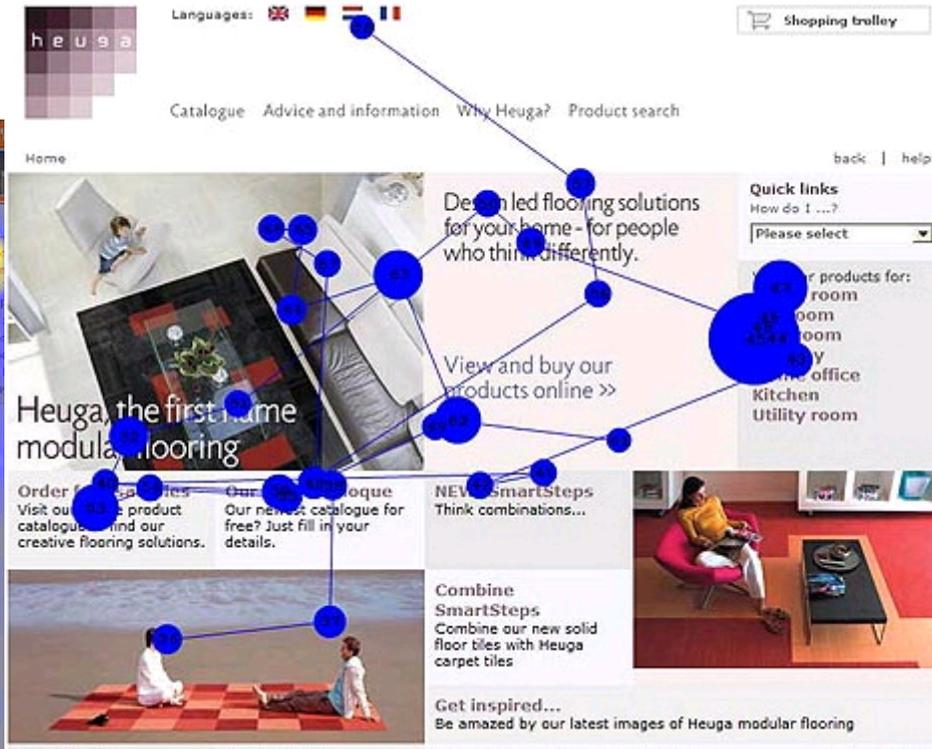

<http://www.mangold-international.com>

<http://www.useit.com/eyetracking>

# Optical Illusions

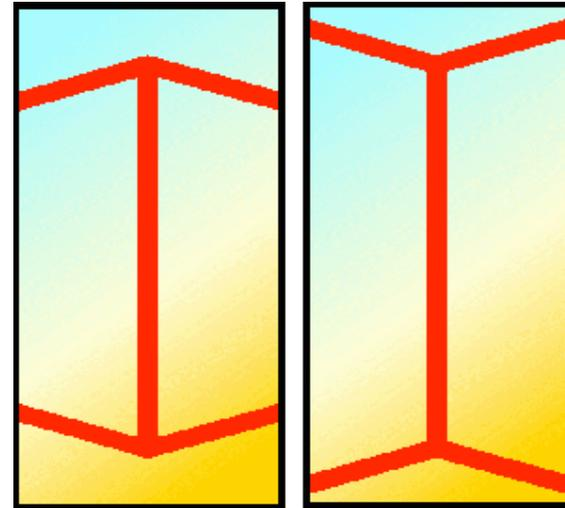
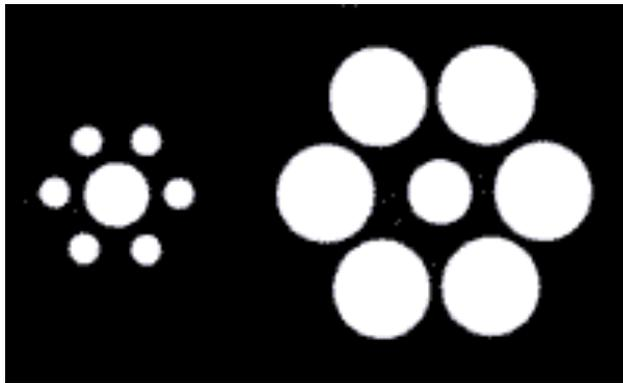

[www.eyetricks.com](http://www.eyetricks.com)

# Color Keys Can be Misleading

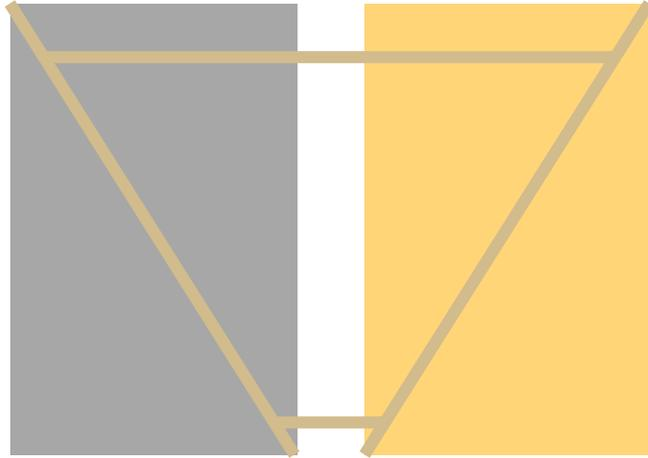

1mg
2mg
5mg
10mg
20mg
50mg
80mg
>200mg

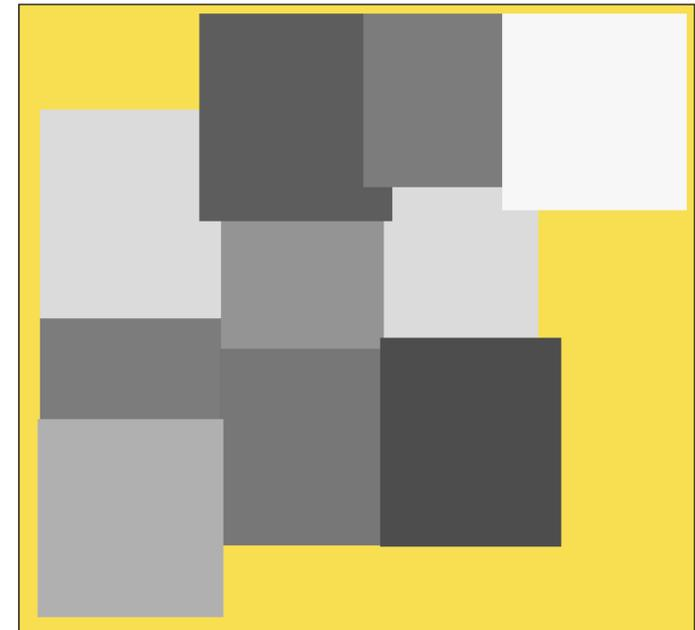

# Pre-attentive and Attentive Pattern Recognition

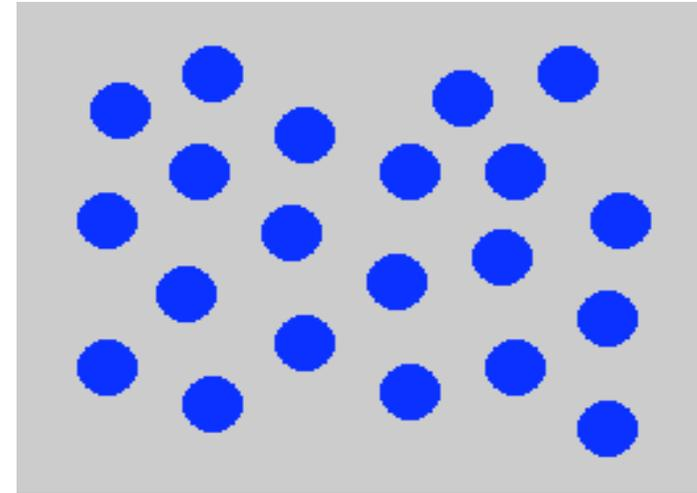
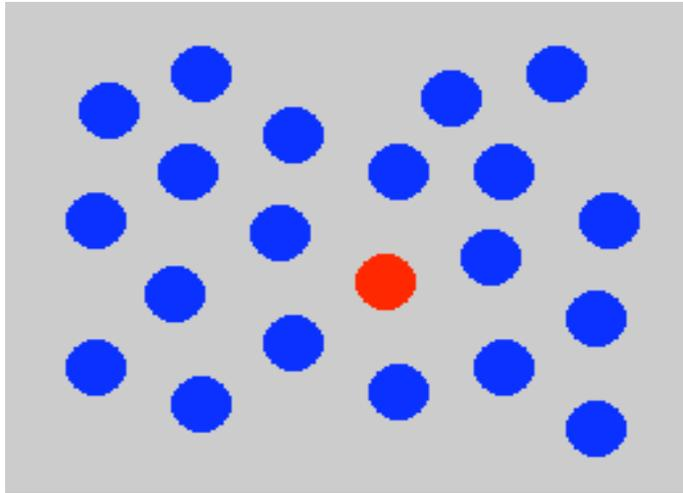

Viewer can rapidly and accurately determine whether the target (red circle) is present or absent. Difference detected in color.

Hearst, 2003

## **Pre-attentive** processing:

Processed without focusing attention

Constant time < 200-250 ms independent of number of distractors

(Eye movements take 200 ms)

# Preattentive and Attentive Pattern Recognition

parallel

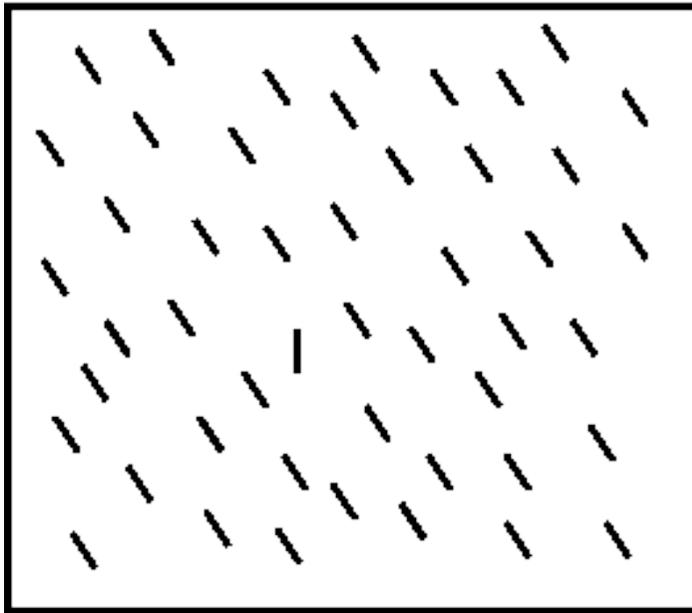

seriell

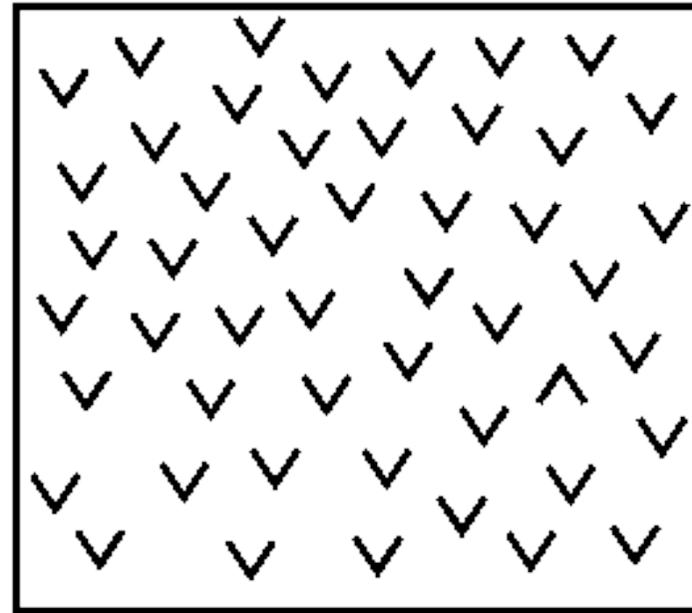

# Gestalt Psychology – Principle 1

- Emergence



<http://sharp.bu.edu/~slehar/webstuff/bubw1/dog.gif>

# Gestalt Psychology – Principle 2

- Reification

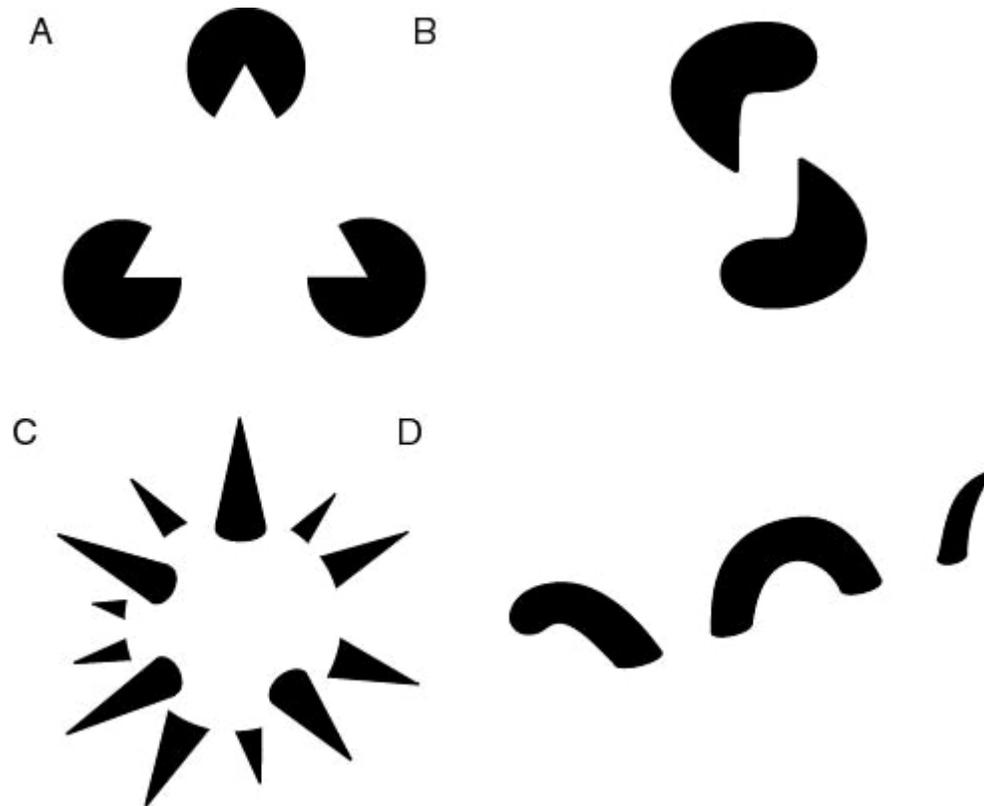

[http://en.wikipedia.org/wiki/Gestalt\\_psychology](http://en.wikipedia.org/wiki/Gestalt_psychology)

# Gestalt Psychology – Principle 3

- Multistability

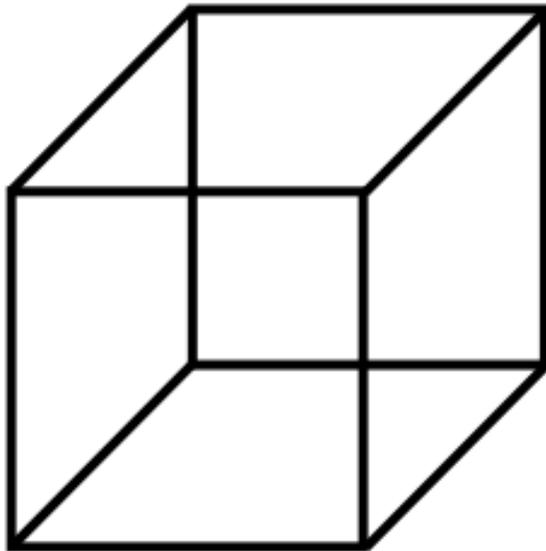

[http://en.wikipedia.org/wiki/Gestalt\\_psychology](http://en.wikipedia.org/wiki/Gestalt_psychology)

# Gestalt Psychology – Principle 4

- Invariance

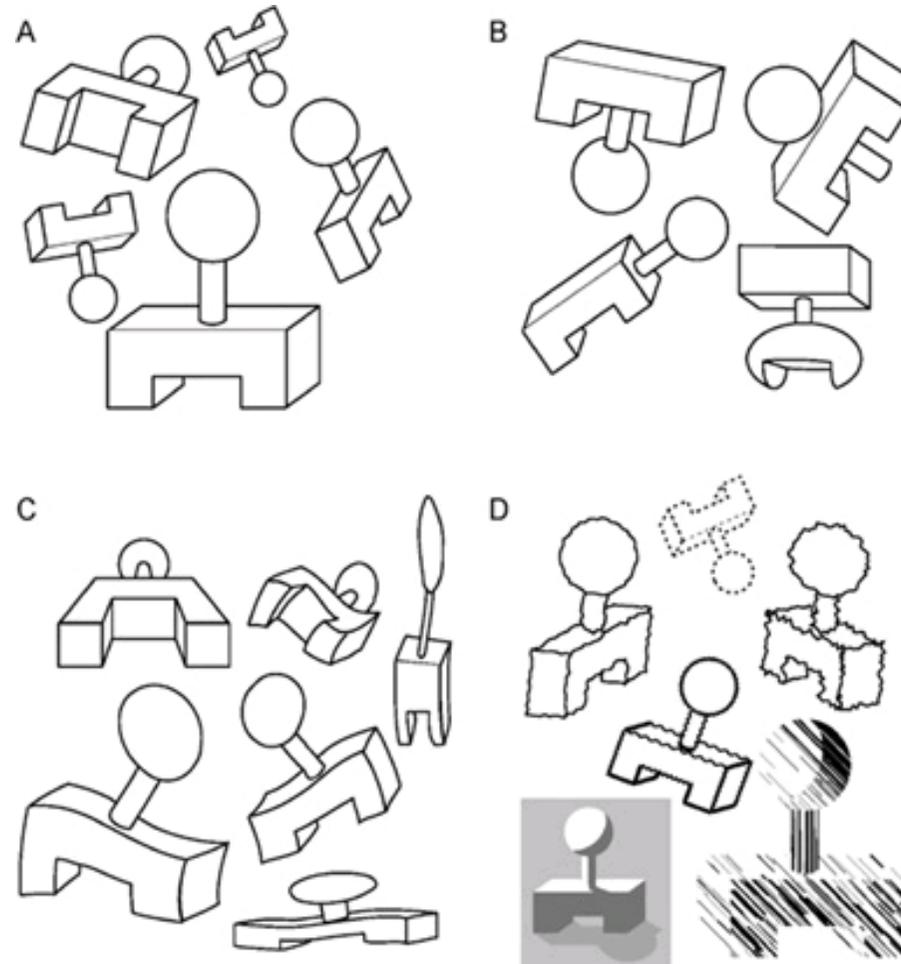

[http://en.wikipedia.org/wiki/Gestalt\\_psychology](http://en.wikipedia.org/wiki/Gestalt_psychology)

# Gestalt Theory - Prägnanz

- Law of Closure
  - The mind may experience elements it does not perceive through sensation, in order to complete a regular figure (that is, to increase regularity).
- Law of Similarity
  - The mind groups similar elements into collective entities or totalities. This similarity might depend on relationships of form, color, size, or brightness.
- Law of Proximity
  - Spatial or temporal proximity of elements may induce the mind to perceive a collective or totality.
- Law of Symmetry
  - Symmetrical images are perceived collectively, even in spite of distance.
- Law of Continuity
  - The mind continues visual, auditory, and kinetic patterns.
- Law of Common Fate
  - Elements with the same moving direction are perceived as a collective or unit.

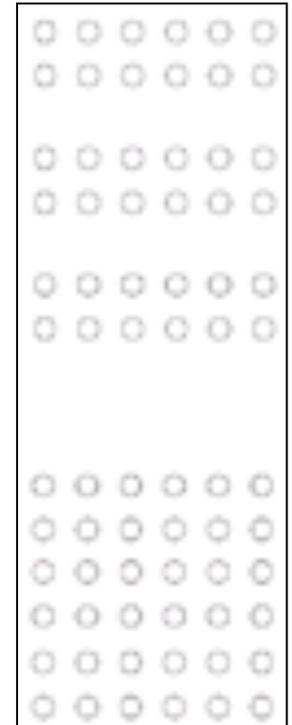
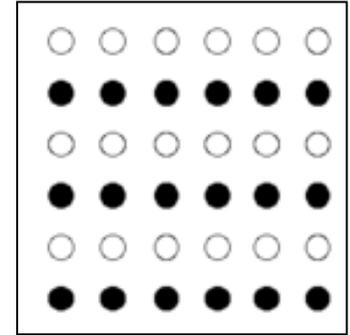

[http://en.wikipedia.org/wiki/Gestalt\\_psychology](http://en.wikipedia.org/wiki/Gestalt_psychology)

# Gestalt Perception – Real World Example

- Keep red
- Off line
- ???



# Gestalt Perception – Real World Example

- Keep off red lines
- !!!





# Human Hearing

- Two Ears
  - information about the environment
  - type of sound source
  - distance and direction
- Physical apparatus:
  - outer ear – protects inner ear and amplifies sound
  - middle ear – transmits sound waves as vibrations to inner ear
  - inner ear – chemical transmitters are released and cause impulses in auditory nerve
- Sound
  - Pitch (Tonhöhe) – sound frequency
  - Loudness (Lautstärke) – amplitude
  - Timbre (Klangfarbe) – type or quality

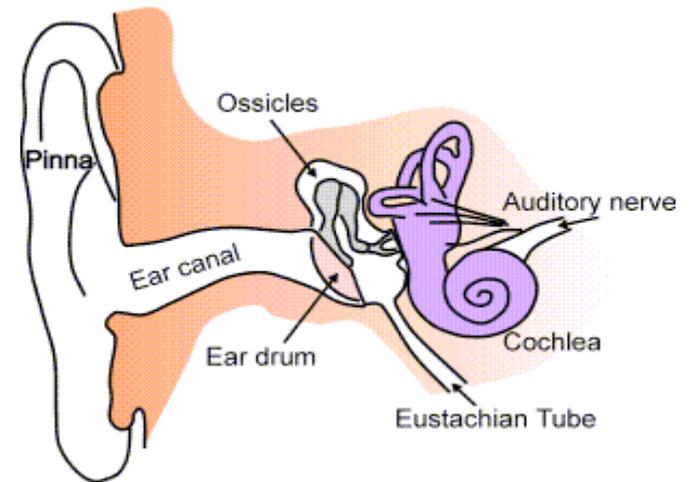

Source:  
Wikipedia  
and Dix et al.

# Threshold of Hearing for Different Age Groups

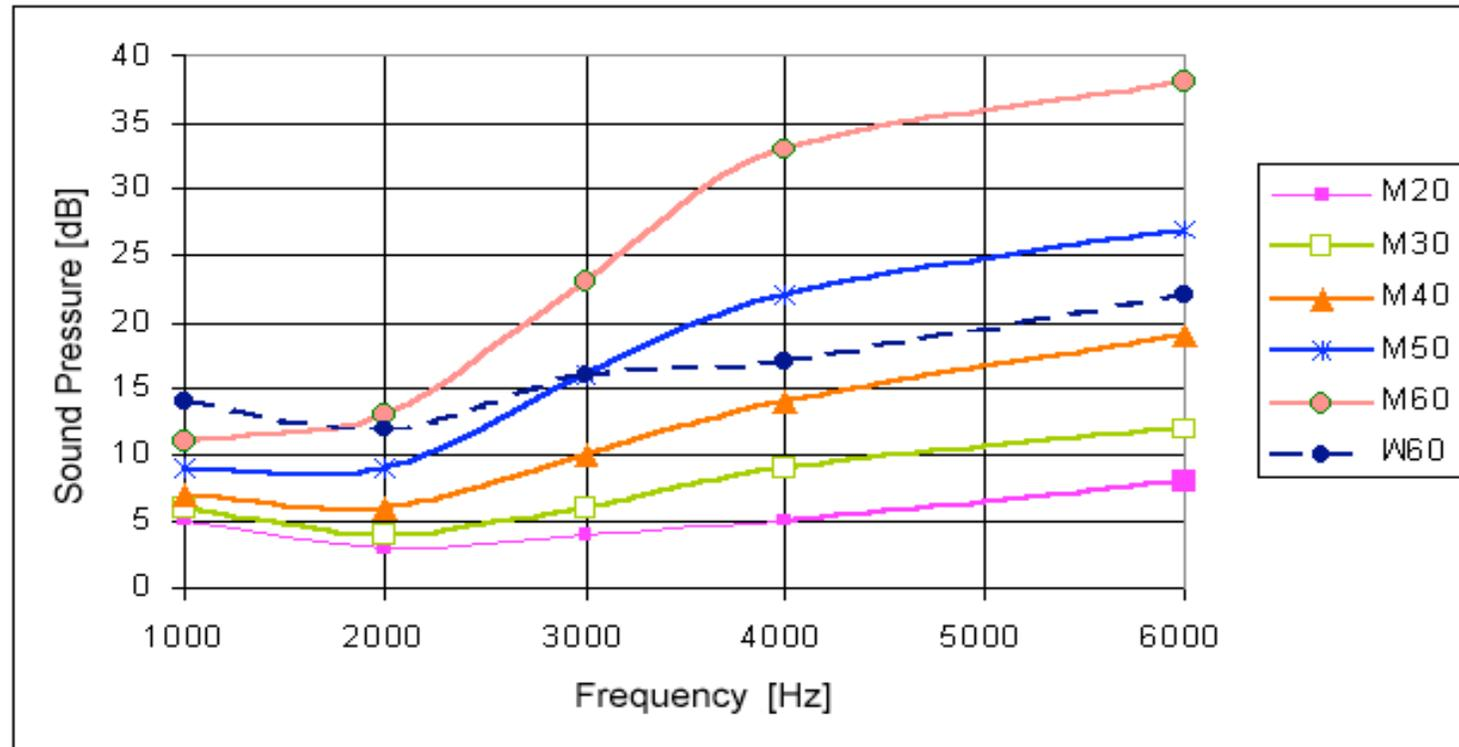

Thresholds of hearing for male (M) and female (W) subjects between the ages of 20 and 60  
(for details see [http://en.wikipedia.org/wiki/Absolute\\_threshold\\_of\\_hearing](http://en.wikipedia.org/wiki/Absolute_threshold_of_hearing))

# Spatial hearing

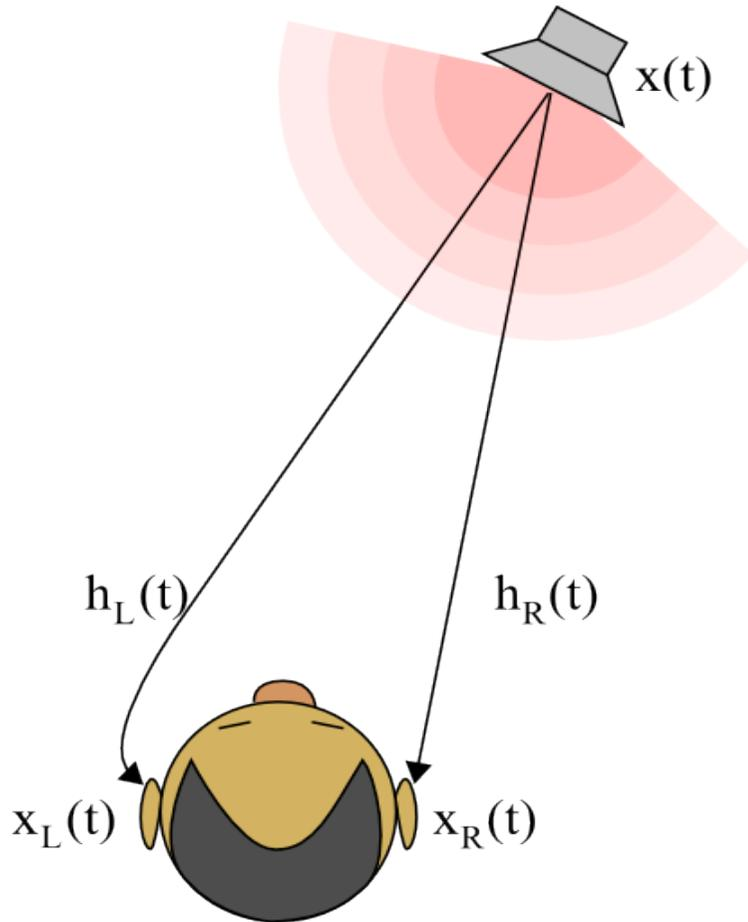

- Caused by:
  - Interaural time difference (ITD)
  - Interaural intensity difference (IID)
  - Head related transfer functions (HRTF)
- Better for high than for low frequencies

# Example: Audio as Input

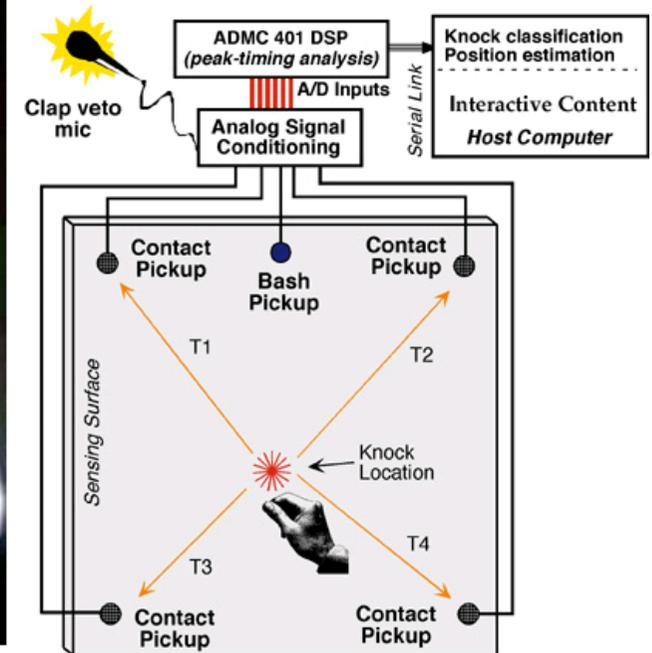
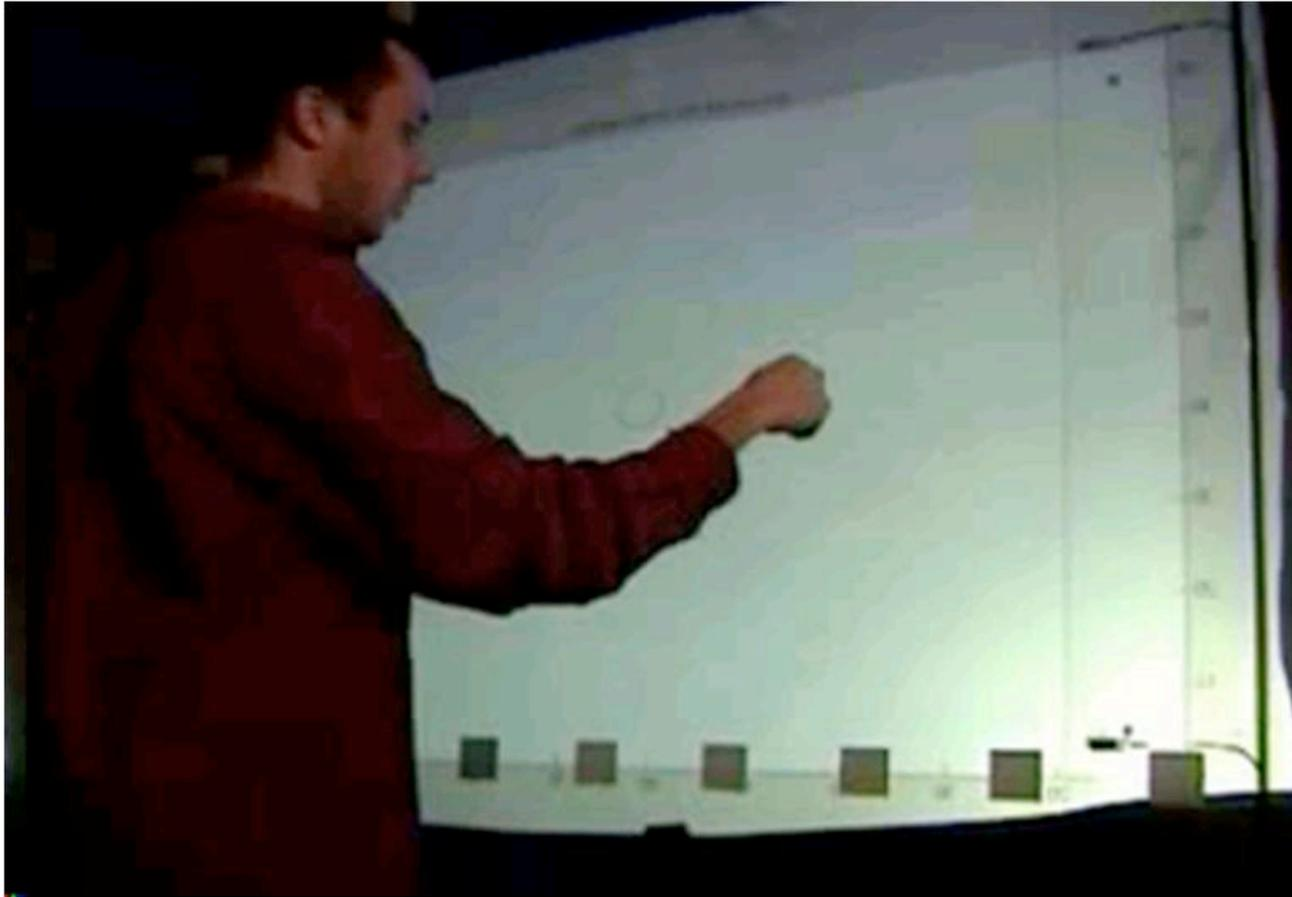

<http://www.media.mit.edu/reserv/Tapper/>

# Other Senses – Touch

- Provides important feedback about environment.
  - May be key sense for the visually impaired.
- Stimulus received via receptors in the skin:
  - Thermoreceptors            – heat and cold
  - Nociceptors                 – pain
  - Mechanoreceptors         – pressure  
(some instant, some continuous)
  - Some areas more sensitive than others e.g. fingers
- Proprioceptors:
  - Signal status of muscles and joints
  - Proprioception: unconscious perception of movement and spatial orientation
  - Kinesthesia: the ability to feel movements of the limbs and body

(see [http://www.isr.syr.edu/course/neu211/lecture\\_notes/lec14.html](http://www.isr.syr.edu/course/neu211/lecture_notes/lec14.html))

# Other Senses – Touch



<http://www.cutecircuit.com/projects/wearables/thehugshirt/>

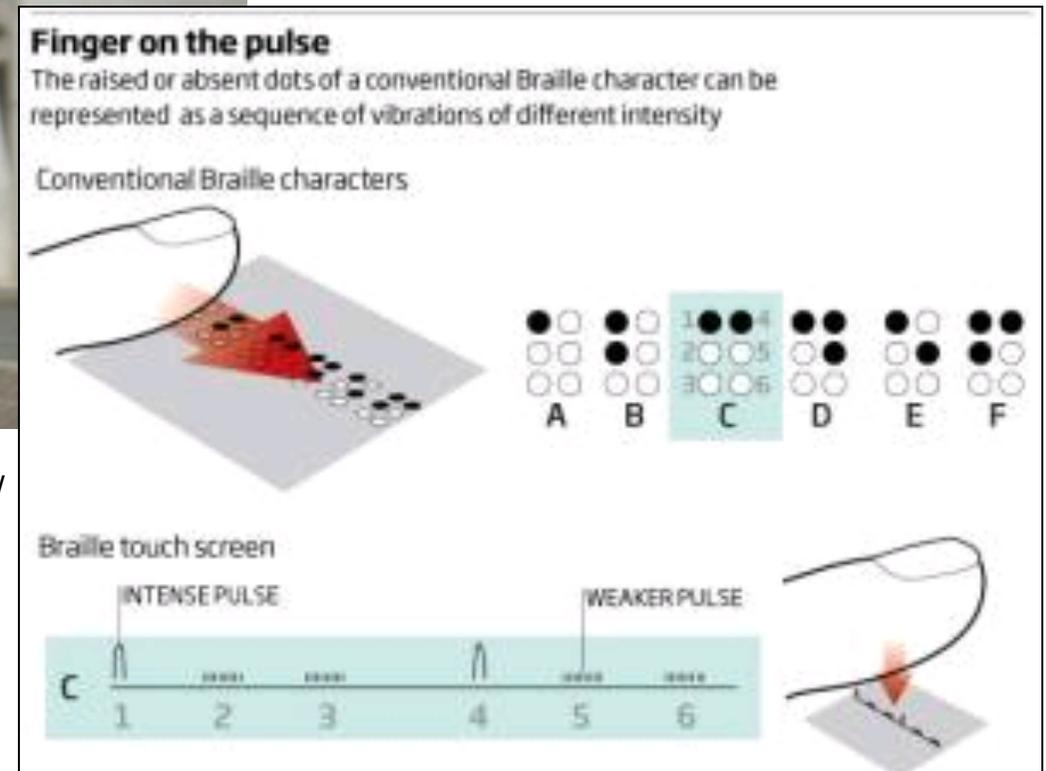

Methods for Presenting Braille Characters on a Mobile Device with a Touchscreen and Tactile Feedback  
Rantala, J.; Raisamo, R.; Lylykangas, J.; Surakka, V.; Raisamo, J.; Salminen, K.; Pakkanen, T.; Hippula, A.;  
IEEE Transactions on Haptics, Volume 2, Issue 1, Jan.-March 2009 Page(s):28 - 39

# Multi-User Touch Screen

- E.g. Mitsubishi DiamondTouch [P. Dietz, D. Leigh, UIST 2002]
- Array of antennas embedded in touch surface
- Each antenna transmits a unique signal
- Separate receiver for each user connected capacitively, typically through the user's chair
- Sequence of actions:
  1. User touches surface
  2. Signal is transmitted from antenna through the user's body to receiver
  3. Touch coordinates are determined by the unique signal
- Distinguishes between
  - Simultaneous inputs from multiple users
  - Multiple touches by a single user (e.g. two handed touch gestures)



Mitsubishi DiamondTouch

# Other Senses – Smell



[www.scentury5d.com/](http://www.scentury5d.com/)



See for example: <http://www.aromajet.com/game.htm>  
and J. Kaye, Making scents: aromatic output for HCI

# Other Senses – Smell



Before movie

Movie starts

Fragrance 1

Fragrance 2

Fragrance 3

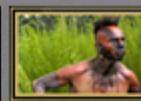
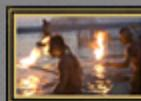

Fragrance 4

Fragrance 5



Fragrance 6

Fragrance 7

Movie ends



## Fragrances heighten key scenes

Fragrances matched to scene moods create strong impressions of the legendary romance between John Smith and Pocahontas.

- ◇Fragrance 1 Elation and journey (0:00:00 - 0:00:00)
- ◇Fragrance 2 Grandeur of nature (0:01:14 - 0:07:00)
- ◇Fragrance 3 Joy of new love (0:37:46 - 0:42:34)
- ◇Fragrance 4 Chief's anger (0:59:17 - 1:01:40)
- ◇Fragrance 5 Grief of separation (1:44:10 - 1:45:50)
- ◇Fragrance 6 Acceptance (1:52:26 - 1:54:13)
- ◇Fragrance 7 Love's inspiration (2:01:47 - 2:11:34)

NTT Communications , Movie Enhanced with Internet-based Fragrance System  
[http://www.in70mm.com/news/2006/new\\_world/index.htm](http://www.in70mm.com/news/2006/new_world/index.htm)

# Capabilities of Humans and Machines

- Designing Systems for Humans
- Senses and Sensing
- Cognitive Abilities and Memory
- Hardware Technologies for Interaction
- Natural and Intuitive Interaction, Affordances

# Model of the Human “Processor” (1)

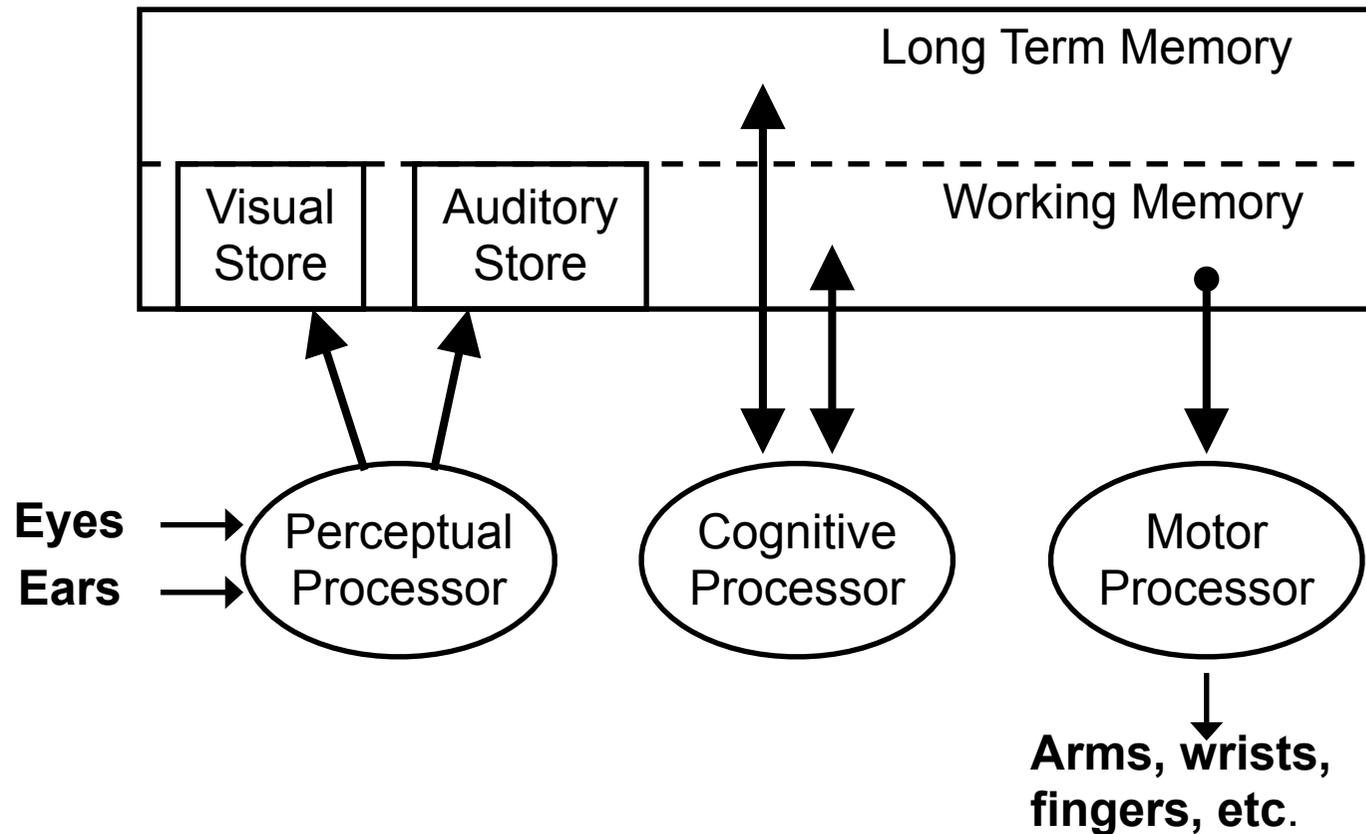

From Brian P. Bailey, Computer Science 498bbp, Psychology of HCI  
See also Card, Moran and Newell 1983, and Dix chapter 1

# Model of the Human “Processor” (2)

- Reaction/processing time, examples:
  - Perception (stimulus); typical time:  $TP \sim 100\text{ms}$
  - Simple decision; typical time:  $TC \sim 70\text{ms}$
  - Minimal motion; typical time:  $TM \sim 70\text{ms}$   
(example for complex motor action see Fitts' law, KLM)
- Overall time for operation where there is a sequential processing
  - pressing a button when a light comes on is about 240ms  
 $T = TP + TC + TM$
  - Matching a symbol and then pressing one of two buttons is about 310ms (2TC because there is comparison and decision)  
 $T = TP + 2TC + TM$
- Processing can also be parallel  
(e.g. phoning while writing, talking while driving, ...)

# Physiology of Memory

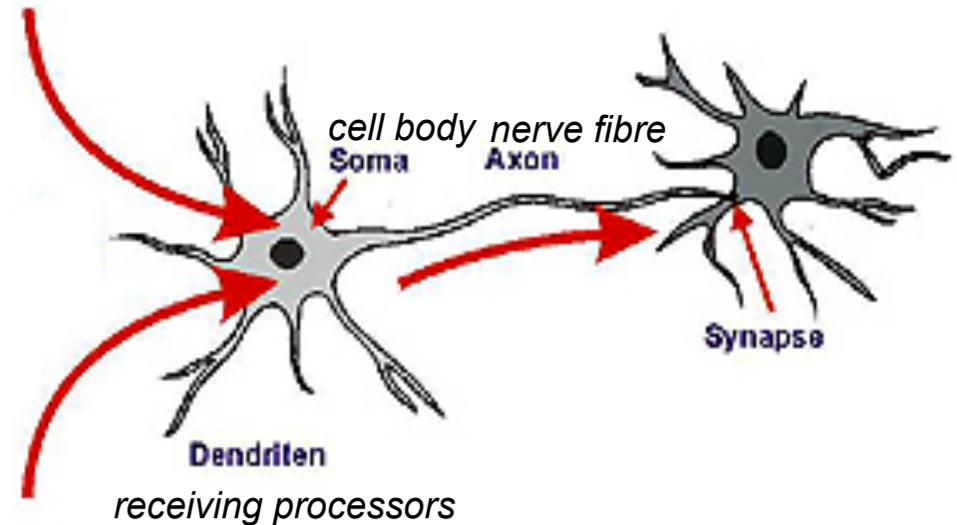
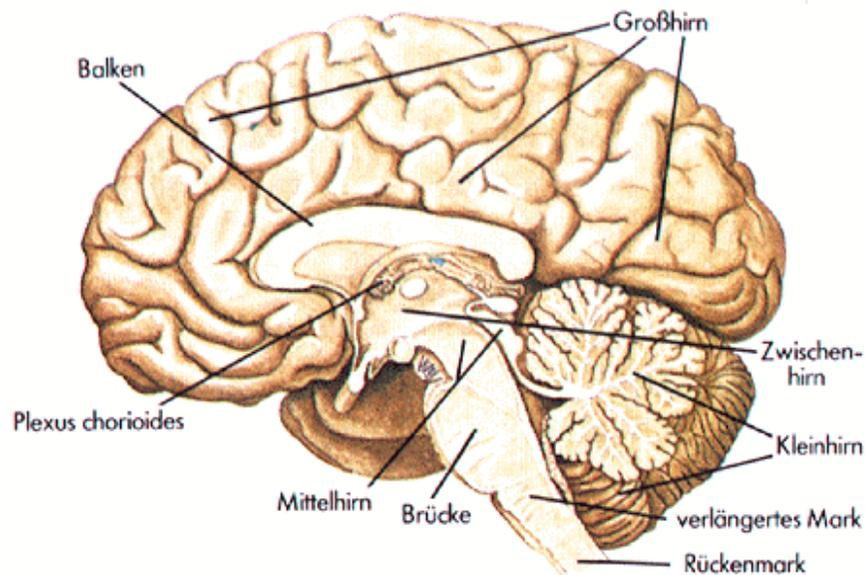

- Memory can be explained as structural change on synaptic level
  - Synaptic connections are enforced/multiplied and reduced
- Since the 60s multi-level models of human memory are used

# Model of Human Memory

“Memory is the process involved in retaining, retrieving, and using information about stimuli, images, events, ideas, and skills after the original is no longer present.”  
(Goldstein, p. 136)

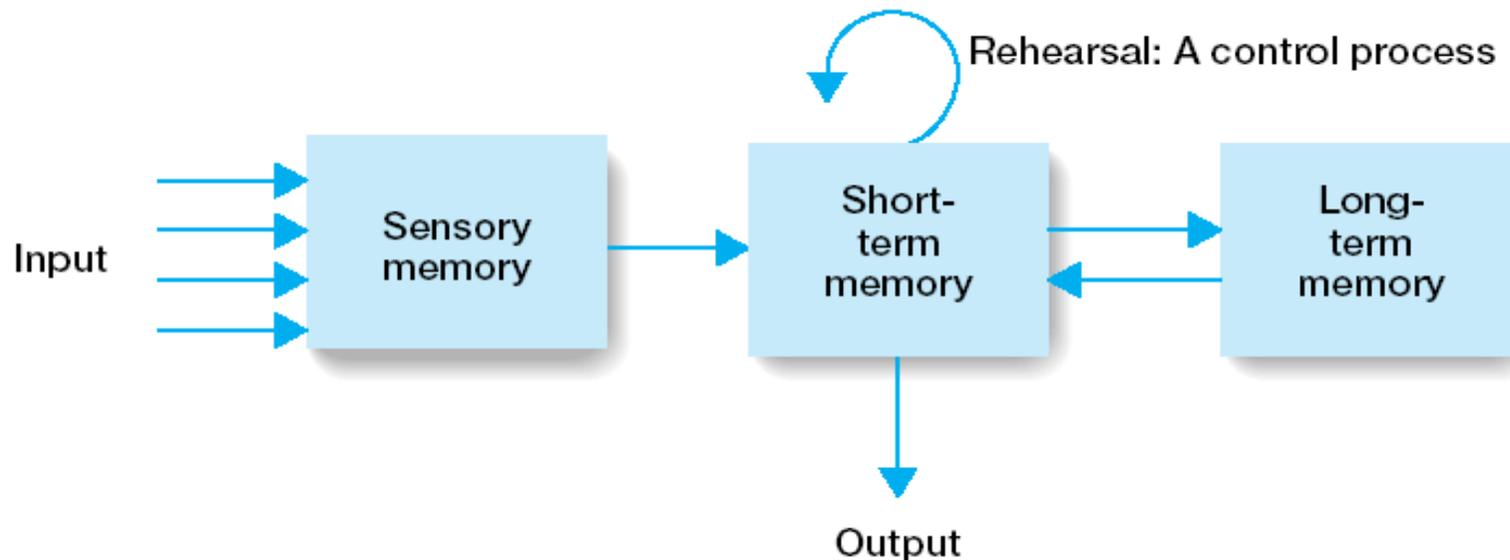
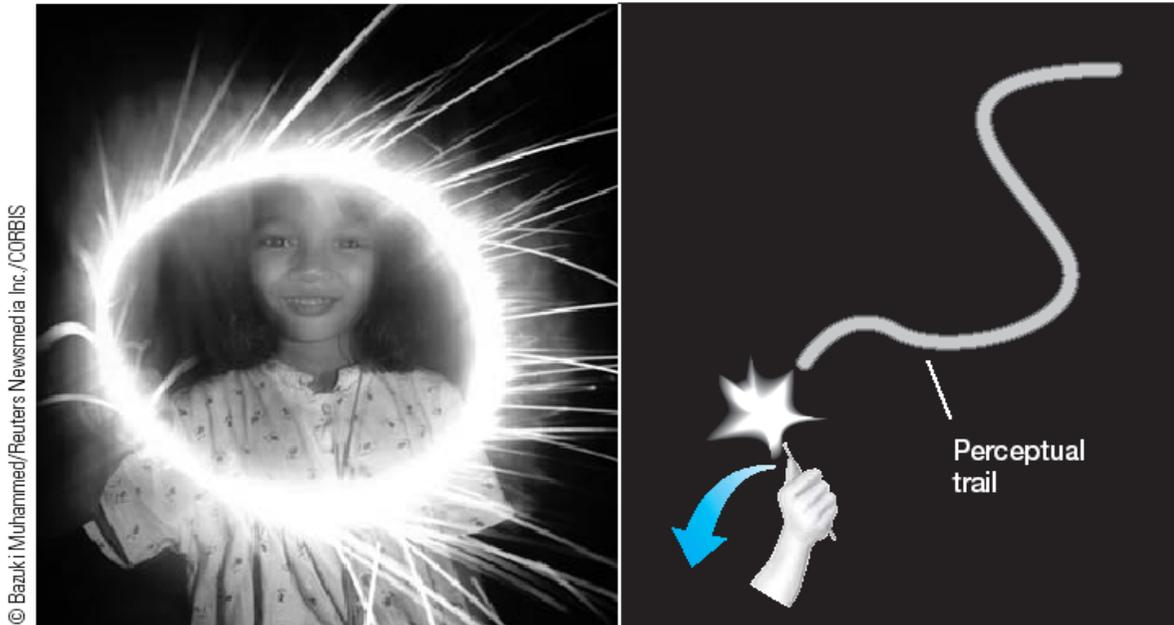

**Figure 5.3** Flow diagram for Atkinson and Shiffrin’s (1968) model of memory. This model, which is described in the text, is called the *modal model* because of the huge influence it has had on memory research.

(from: Goldstein, p. 139)

# Sensory Memory

- “Sensory Memory is the retention, for brief periods of time, of the effects of sensory stimulation.” (Goldstein, p. 140)
- E.g. Persistence of vision



(Image from Goldstein, p. 142)

# Sensory Memory

- Sensory memory functions:
  - collecting information for processing
  - selective, controlled by other (conscious and unconscious) processes
  - holding information briefly while initial processing is going on
  - filling in the blanks when stimulation is intermittent

(from: Goldstein, p. 145)

- Buffers for stimuli received through senses
  - iconic memory: visual stimuli
  - echoic memory: aural stimuli
  - haptic memory: tactile stimuli
- Examples
  - “sparkler” trail
  - stereo sound
  - watching a film
- Continuously overwritten

# Short Term Memory Example: Memorizing

- Memorize:

2 7 5 9 2 8 1 2 9 1 6 3

49 174 99 26 69

49 1 pizza now

heh ousew asg reena ndb igt

# Short-Term Memory (STM)

- Scratch-pad for temporary recall
  - rapid access ~ 70ms
  - rapid decay ~ 200ms
  - limited capacity:  $7 \pm 2$  “chunks”
- Transition from SM to STM
  - by focusing attention
  - kept in STM by rehearsal
- George Miller’s theory of how much information people can remember
  - <http://www.well.com/user/smalin/miller.html>  
(The Psychological Review, 1956, vol. 63, pp. 81-97)
  - People’s immediate memory capacity is very limited
  - In general one can remember 5-9 chunks
  - Chunks can be letters, numbers, words, sentences, images, ...
- Modern theory speaks of *Working Memory* instead of STM
  - stresses manipulation of contents

# Careful Application of the Miller Theory

- Does the  $7 \pm 2$  rule give guidance in interaction design?
  - Present at most 7 options on a menu
  - Display at most 7 icons on a tool bar
  - Have no more than 7 bullets in a list
  - Place at most 7 items on a pull down menu
  - Place at most 7 tabs on the top of a website page
- **But this is wrong!**  
**Why?**
  - People can scan lists of bullets, tabs, menu items, they don't have to recall them from memory
  - People have a tendency to *externalize* memory
    - » Memory in the environment
    - » See chapter on space

# Cognitive Model of Multimedia Learning

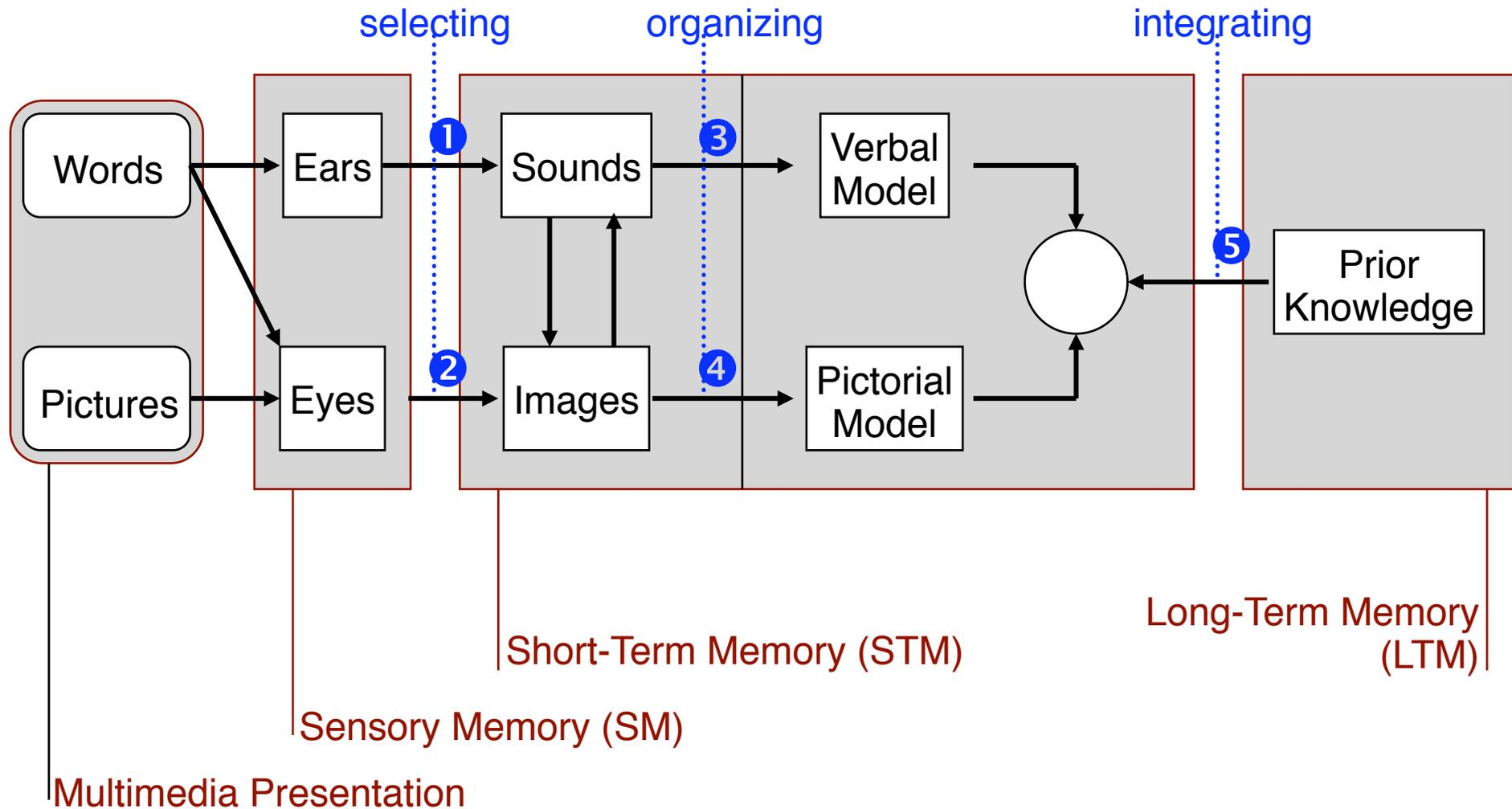

Richard Meyer 2001

# Long-term memory (LTM)

- Repository for all our knowledge
  - slow access ~ 1/10 second
  - slow decay, if any
  - huge or unlimited capacity
- Two types of LTM
  - episodic      – serial memory of events
  - semantic      – structured memory of facts, concepts, skills
- Semantic memory structure
  - provides access to information
  - represents relationships between bits of information
  - supports inference
  - Model: semantic network

# LTM - semantic network

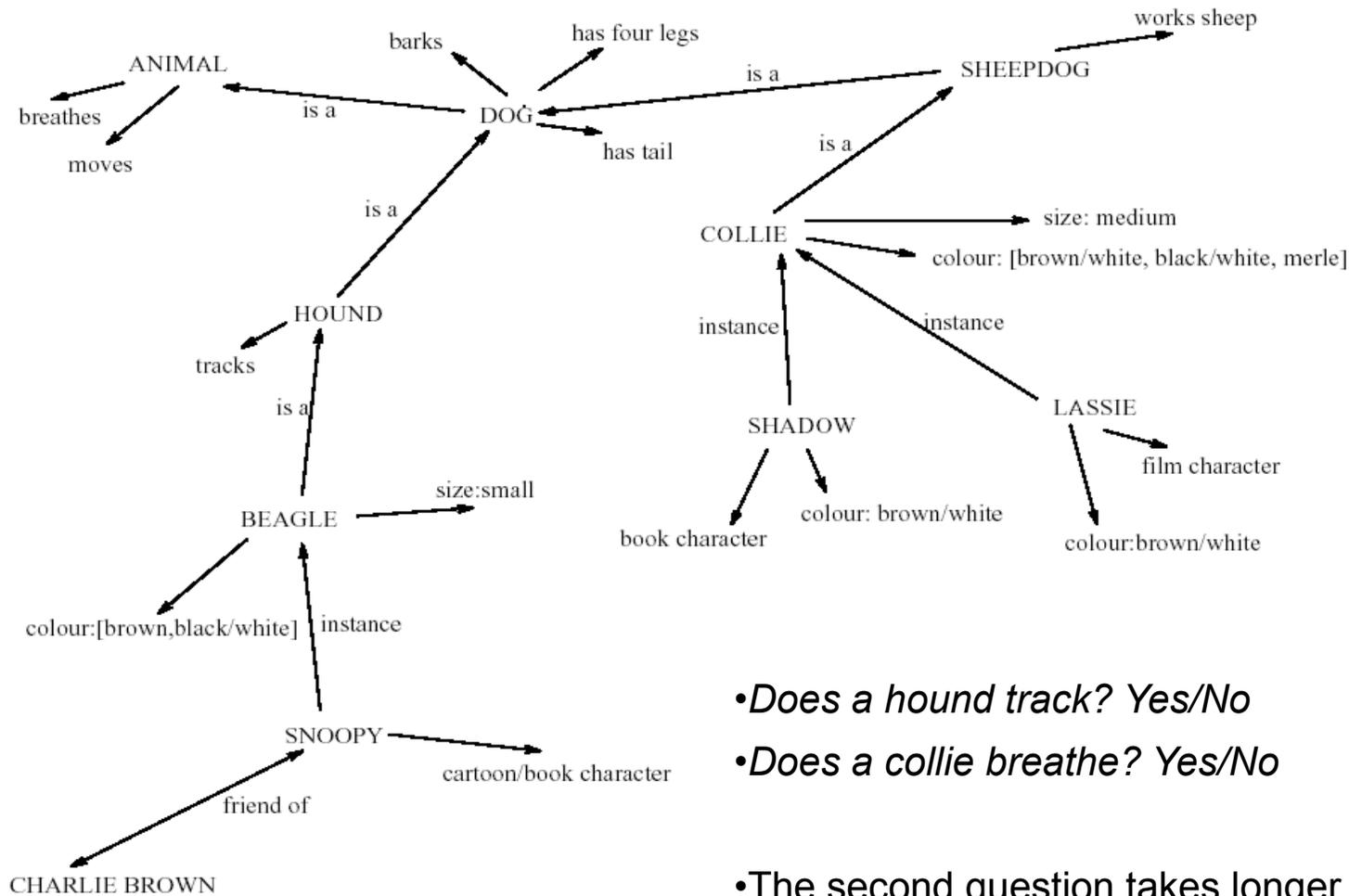

- *Does a hound track? Yes/No*
- *Does a collie breathe? Yes/No*
- The second question takes longer to answer!

# LTM - Storage of Information

- Rehearsal
  - Information moves from STM to LTM
- Total time hypothesis
  - Amount retained proportional to rehearsal time
- Distribution of practice effect
  - Optimized by spreading learning over time
- Structure, meaning and familiarity
  - Information easier to remember

# LTM - Forgetting and Retrieval

## Forgetting:

### decay

- » information is lost (made less accessible?) gradually but very slowly

### interference

- » new information replaces old: retroactive interference
- » old may interfere with new: proactive inhibition

all memory is selective, affected by emotion, may “choose” to forget

## Retrieval:

### recall

- » information reproduced from memory can be assisted by cues, e.g. categories, imagery

### recognition

- » information gives knowledge that it has been seen before
- » less complex than recall - information is cue

# Thinking: Modes of Reasoning

- Deduction:
  - derive logically necessary conclusion from given premises.  
e.g. If it is Friday then she will go to work  
It is Friday  
Therefore she will go to work.
  - Logical conclusion not necessarily true, dependent on assumptions
- Induction:
  - generalize from cases seen to cases unseen  
e.g. all elephants we have seen have trunks  
therefore all elephants have trunks.
  - Unreliable: can only be disproven
- Abduction:
  - reasoning from event to cause  
e.g. Sam drives fast when drunk.  
If I see Sam driving fast, assume drunk.
  - Unreliable: can lead to false explanations

# Example for Inductive Reasoning: Wason's cards

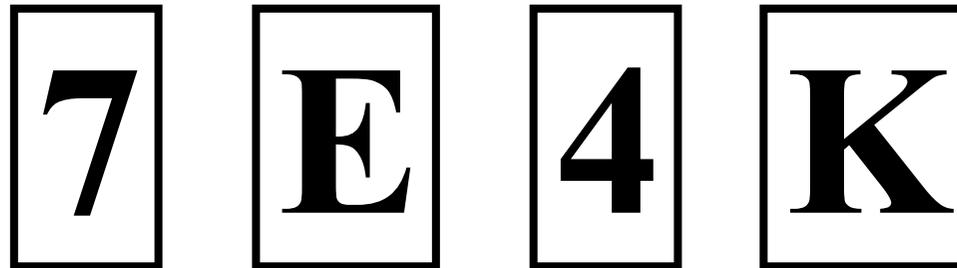

Each card has a letter on one side and a number on the other.

If a card has a vowel on one side it has an even number on the other.

Is this true?

How many cards do you need to turn over to find out?

.... and which cards?

# Capabilities of Humans and Machines

- Designing Systems for Humans
- Senses and Sensing
- Cognitive Abilities and Memory
- Hardware Technologies for Interaction
- Natural and Intuitive Interaction, Affordances

# Basic Input Operations

- Text Input
  - Continuous
    - » Keyboard and alike
    - » Handwriting
    - » Spoken
  - Block
    - » Scan/digital camera and OCR
- Pointing & Selection
  - Degree of Freedom
    - » 1, 2, 3, 6, <more> DOF
  - Isotonic vs. Isometric
  - Translation function
  - Precision
  - Technology
  - Feedback
- Direct Mapped Controls
  - Hard wired buttons/controls
    - » On/off switch
    - » Volume slider
  - Physical controls that can be mapped
    - » Softkeys on mobile devices
    - » Function keys on keyboards
    - » Industrial applications
- Media capture
  - Media type
    - » Audio
    - » Images
    - » Video
  - Quality/Resolution
  - Technology

# Basic Output Operations

- Visual Output
  - Show static
    - » Text
    - » Images
    - » Graphics
  - Animation
    - » Text
    - » Graphics
    - » Video
- Audio
  - Earcons / auditory icons
  - Synthetic sounds
  - Spoken text (natural / synthetic)
  - Music
- Tactile
  - Shapes
  - Forces
- Further senses
  - Smell
  - Temperature
  - ...
- Technologies
  - Visual
    - » Paper
    - » Objects
    - » Displays
  - Audio
    - » Speakers/Headphones
    - » 1D/2D/3D
  - Tactile
    - » Objects
    - » Active force feedback

# Design Space and Technologies

## Why do we need to know about input/output technologies?

- For standard applications
  - Optimal adaptation to human workflow
  - Support for user variety
- For specific custom made applications
  - Understanding available options
  - Creating a different experience (e.g. for exhibition, trade fare, museum, ...)

# Analysis of the Computer's "Senses"

- Adapted from Chris Crawford 2002 p. 50 ff

Computer's steps	1980 Technology	2000 Technology	2010 Technology	Improvement Factor
<i>Speaking</i>	24 x 80 B&W Characters Sound = beep	800 x 600 24-Bit colors Graphics 44 kHz Stereo	1900 x 1450 36-Bit colors 96kHz Dolby Surround	1500 x
<i>Thinking</i>	1 MHz 8-bit 16 K RAM	300 MHz 32-bit 64 MB RAM	3.3 GHz 64-bit 8 GB RAM	250 000 x
<i>Listening</i>	Keyboard	Keyboard + Mouse	Keyboard + Mouse + Speech	3 x

The "speaking" abilities of computers (visual and auditive) are well developed – they go beyond the human "hearing" abilities.

The "hearing" abilities of computers are dramatically underdeveloped.

This asymmetry makes communication very difficult.

# Examples of Desktop-Oriented Pointing Devices (most with additional functionality)

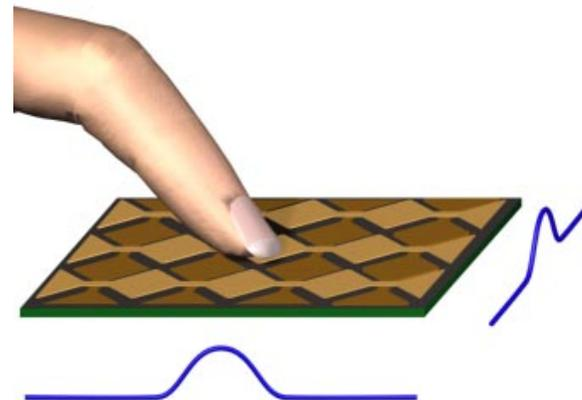

# Classification of Pointing devices

- Dimensions
  - 1D / 2D / 3D
- Direct vs. indirect
  - integration with the visual representation
    - Touch screen is direct
    - Mouse is indirect
- Discreet vs. continuous
  - resolution of the sensing
    - Touch screen is discreet
    - Mouse is continuous
- Absolute vs. Relative
  - movement/position used as input
    - Touch screen is absolute
    - Mouse is relative

# Examples of Off-Desktop Pointing Devices

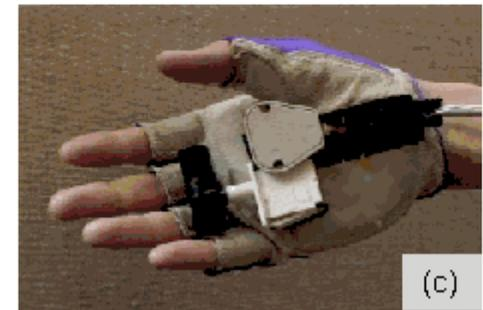
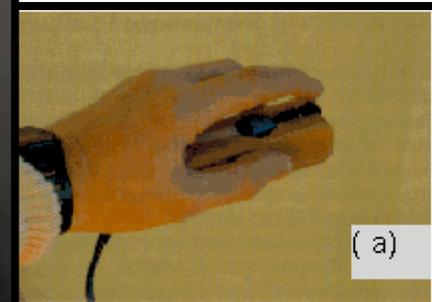
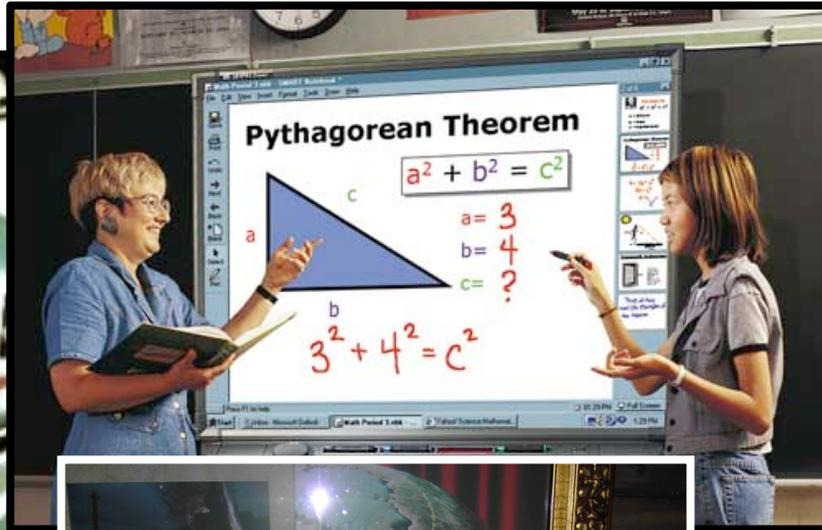

# Controller resistance

- **Isometric**

- pressure devices / force devices
- Infinite resistance
- device that senses force but does not perceptibly move

- **Isotonic**

- displacement devices, free moving devices or unloaded devices
- zero or constant resistance

- **Elastic:** device's resistive force increases with displacement, also called spring-loaded

- **Viscous:** resistance increases with velocity of movement

- **Inertial:** resistance increases with acceleration

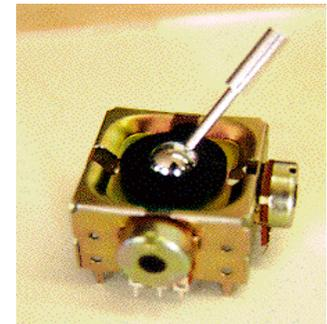
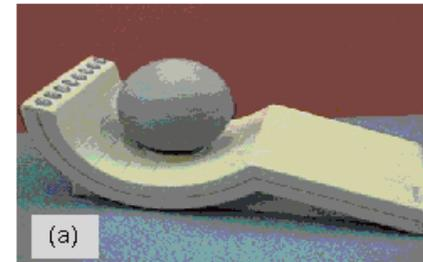

# Phantom – Haptic Device

- high-fidelity 3D force-feedback input device with 6DOF
- GHOST SDK to program it



[www.sensable.com](http://www.sensable.com)

# Interactive Modelling (Merl)

<http://www.merl.com/papers/TR2000-13/>

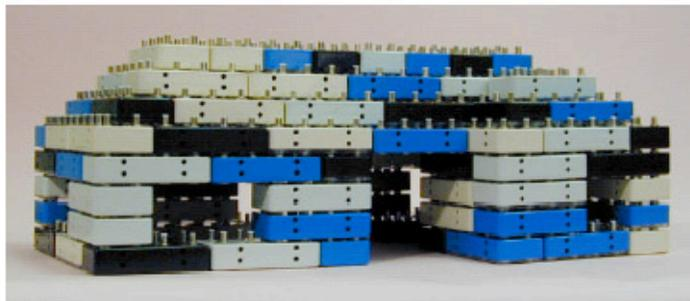

(a)



(b)

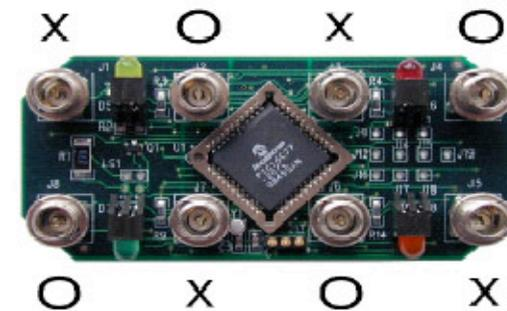

(c)

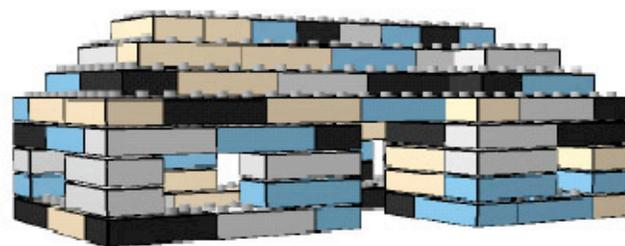

(d)



(e)

Figure 1: (a) a physical block structure comprising 98 blocks; (b) a close-up of the blocks; (c) a bottom view of the circuit board inside each block; and renderings of the virtual model recovered from the structure, one literal (d) and one interpreted (e). The literal rendering uses associated shapes and colors to render the blocks. The virtual model is augmented automatically for the interpreted rendering.

# Volumetric 3D Display

- Auto stereoscopic
- Volume Image
- Supports multiple simultaneous viewers (multiple viewpoints)



E.g. Perspecta™ 3D

Swept-screen multiplanar volumetric display  
198 2-D slices  
768 x 768 pixel slice resolution  
100 million voxels  
24 Hz volume refresh  
10" diameter spherical image  
8 colors at highest resolution  
Viewing Angle: 360° horizontal, 270° vertical

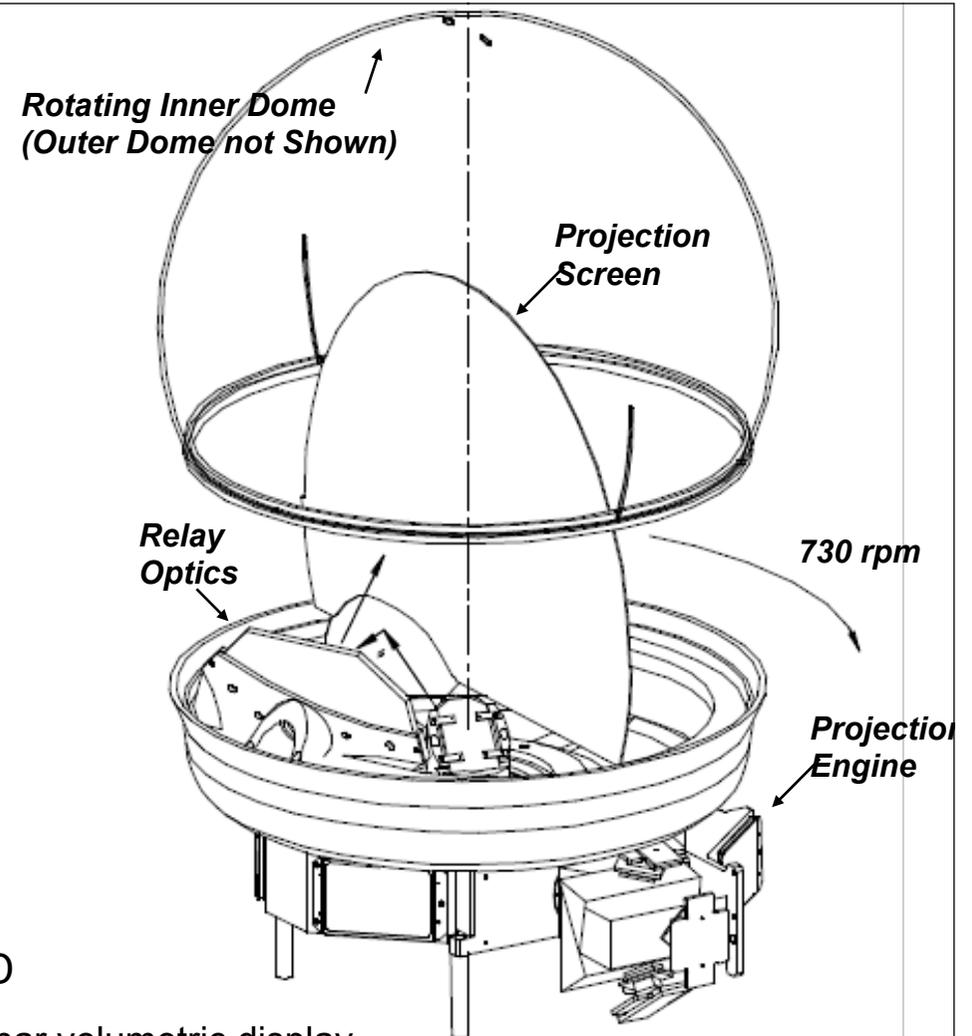

<http://actuality-systems.com/>

# Electronic Paper Display (EPD)

- E-Ink Technology
- Millions of tiny microcapsules
- Each microcapsule contains
  - A clear fluid
  - Positively charged white particles
  - Negatively charged black particles suspended in a clear fluid
- Only particles on the top are visible
- Electronic field determines if white or black particles move to the top
- Minimal energy consumption needed
- No energy needed to maintain images
- High contrast
- Sunlight readable

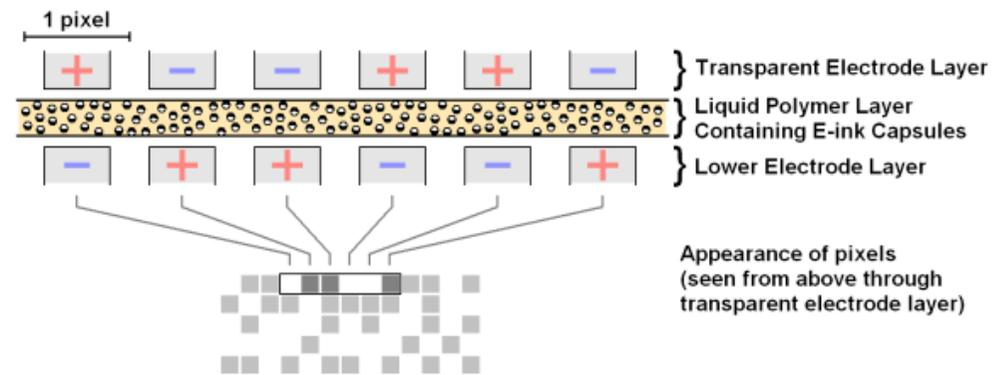

## Cross Section of Electronic-Ink Microcapsules

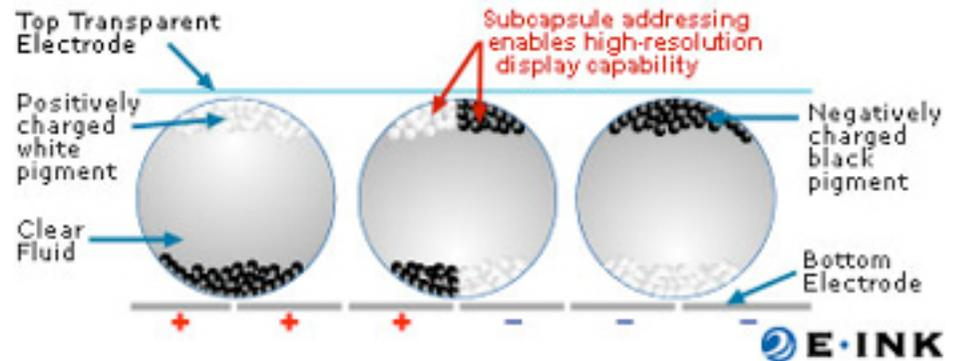

# Interactive Surfaces Based on Cameras

- E.g. SmartTech SmartBoard DViT:  
<http://www.smarttech.com/dvit/index.asp>
- Vision based: cameras in each corner
- Nearly on any surface
- More than one pointers
- No special pen required



Figure 1: DViT Technology Camera

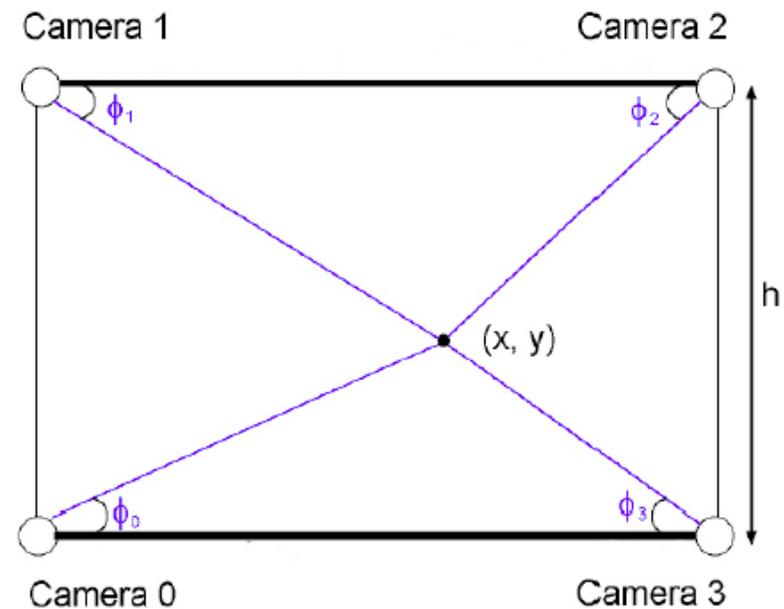

Figure 2: Camera Identification of a Contact Point

# Continuous Information Spaces

Share information between different information spaces, e.g. drag something from table to wall.



[Video]

sara 11/22/07  
<http://www.youtube.com/watch?v=HvuH60MBbi4>

# Tangible User Interfaces

- Digital information is coupled to everyday physical objects and information
- User manipulates digital information through the physical environment
- Different types of physical objects:
  - Tools: manipulate digital information
  - Tokens: access stored information
  - Containers: move information between devices or platforms

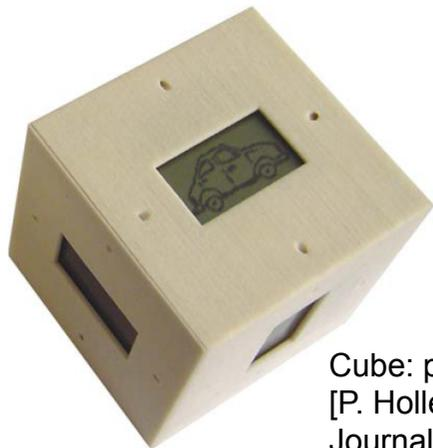

Cube: playful learning interface for children  
[P. Holleis, M. Kranz, A. Winter, A. Schmidt: Playing with the Real World  
Journal of Virtual Reality and Broadcasting, JVRB, April, 2006]

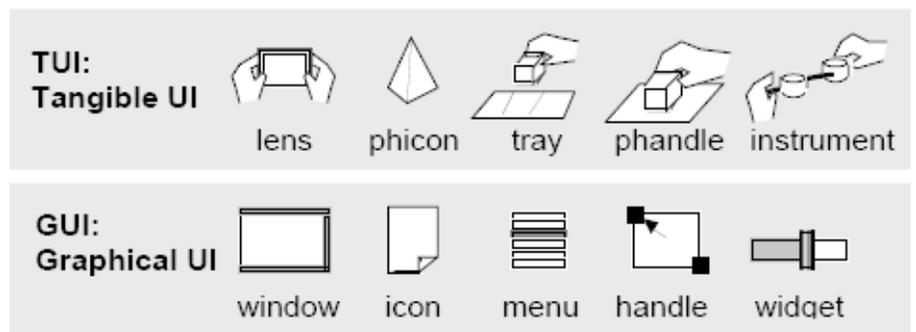

[Ishii H, Ullmer B, CHI'97]  
[Holmquist et al., HUC'99]

# Taxonomy for Input Devices (Buxton)

- Continuous vs discrete?
- Agent of control (hand, foot, voice, eyes ...)?
- What is being sensed (position, motion or pressure), and
- The number of dimensions being sensed (1, 2 or 3)
- Devices that are operated using similar motor skills
- Devices that are operated by touch vs. those that require a mechanical intermediary between the hand and the sensing mechanism

“...basically, an input device is a transducer from the physical properties of the world into the logical parameters of an application.” (W. Buxton)

# Taxonomy for Input Devices (Buxton)

		Number of Dimensions							
		1		2			3		
Property Sensed	Position	Rotary Pot	Sliding Pot	Tablet & Puck	Tablet & Stylus	Light Pen	Isotonic Joystick	3D Joystick	M
					Touch Tablet	Touch Screen			T
	Motion	Continuous Rotary Pot	Treadmill	Mouse			Sprung Joystick Trackball	3D Trackball	M
			Ferinstat				X/Y Pad		T
	Pressure	Torque Sensor					Isometric Joystick		T
		rotary	linear	puck	stylus finger hoiz.	stylus finger vertical	small fixed location	small fixed with twist	

<http://www.billbuxton.com/lexical.html>

Buxton, W. (1983). Lexical and Pragmatic Considerations of Input Structures. *Computer Graphics*, 17 (1), 31-37.

# Physical Properties used by Input devices (Card et al)

	Linear	Rotary
<b>Position</b>		
Absolute	P (Position)	R (Rotation)
Relative	dP	dR
<b>Force</b>		
Absolute	F (Force)	T (Torque)
Relative	dF	dT

Card, S. K., Mackinlay, J. D. and Robertson, G. G. (1991).  
A Morphological Analysis of the Design Space of Input Devices.  
ACM Transactions on Information Systems 9(2 April): 99-122

# Input Device Taxonomy (Card et al)

P: position  
 R: rotation  
 F: force  
 T: torque

d: relative

	Linear			Rotary			
	X	Y	Z	rX	rY	rZ	
<b>P</b>							<b>R</b>
<b>dP</b>							<b>dR</b>
<b>F</b>							<b>T</b>
<b>dF</b>							<b>dT</b>
	1 10 100 inf	1 10 100 inf	1 10 100 inf	1 10 100 inf	1 10 100 inf	1 10 100 inf	

- Scale “1 10 100 inf” indicates the number of possible states

# Input Device Taxonomy (Card et al)

P: position  
 R: rotation  
 F: force  
 T: torque  
  
 d: relative

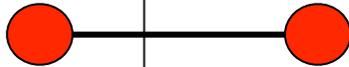
	Linear			Rotary			
	X	Y	Z	rX	rY	rZ	
P							R
dP							dR
F							T
dF							dT
	1 10 100 inf	1 10 100 inf	1 10 100 inf	1 10 100 inf	1 10 100 inf	1 10 100 inf	

- Example: Touch Screen

# Input Device Taxonomy (Card et al)

P: position  
 R: rotation  
 F: force  
 T: torque

d: relative

	Linear			Rotary			
	X	Y	Z	rX	rY	rZ	
P							R
dP							dR
F							T
dF							dT
	1 10 100 inf	1 10 100 inf	1 10 100 inf	1 10 100 inf	1 10 100 inf	1 10 100 inf	

- Example: Wheel mouse

# Capabilities of Humans and Machines

- Designing Systems for Humans
- Senses and Sensing
- Cognitive Abilities and Memory
- Hardware Technologies for Interaction
- Natural and Intuitive Interaction, Affordances

# Emotions – Attractive Things Work Better

- Experiment
  - Six ATMs identical in function and operation
  - Some aesthetically more attractive than others
  - Result: the nicer ones are easier to use...
- Aesthetics can change the emotional state
  - Emotions allow us to quickly assess situations
  - Positive emotion make us more creative
  - Attractive things make feel people good
  - Relaxed users will more likely forgive design shortcomings
- See D. Norman, Emotional Design (Chapter 1)

# Affordance Theory

- Perceived affordance: a situation where an object's sensory characteristics intuitively imply its functionality and use. ([www.usabilityfirst.com](http://www.usabilityfirst.com))
- Perceived affordance is the perceived possibility for action
  - Objective properties that imply action possibilities – how we can use things – independent of the individual (Gibson)
  - Perceived affordance includes experience of an individual (Norman)
  - More than conventions, feedback, etc.
- Example 1: Hammer and nails
- Example 2: Vandalism at a bus stop
  - Concrete → graffiti
  - Glass → smash
  - Wood → carvings

Gibson, J.J. (1979). *The Ecological Approach to Visual Perception*, Houghton Mifflin, Boston. (Currently published by Lawrence Erlbaum, Hillsdale, NJ.)

Norman, D. A. (1988). *The Psychology of Everyday Things*. New York: Basic Books. (The paperback version is Norman, 1990.)

# Natural and Intuitive User Interfaces?

- Very little is intuitive and natural with regard to computer user interfaces!
- To make it feel intuitive and natural
  - Base UIs on previous knowledge of the user (see metaphors)
  - Use clear affordances and constraints
- Affordances for situations? Signifiers!
  - “A ‘**signifier**’ is some sort of indicator, some signal in the physical or social world that can be interpreted meaningfully.”
  - Examples
    - » presence or absence of people on a train platform
    - » painted lines on the street
    - » flag in the wind
    - » trails that signal shortcuts through parks or across planted areas
    - » physical bookmark in a book – scrollbar in an electronic text

# References

- Alan Dix, Janet Finlay, Gregory Abowd and Russell Beale. (2003) Human Computer, Interaction (third edition), Prentice Hall, ISBN 0130461091 <http://www.hcibook.com/e3/>
- Gibson, J.J. (1979). The Ecological Approach to Visual Perception, Houghton Mifflin, Boston. (Currently published by Lawrence Erlbaum, Hillsdale, NJ.)
- Norman, D. A. (1988). The Psychology of Everyday Things. New York: Basic Books. (The paperback version is Norman, 1990.)
- Goldstein, E. Bruce (2004). Cognitive Psychology : Connecting Mind, Research and Everyday Experience, ISBN: 0534577261  
<http://64.78.63.75/samples/05PSY0304GoldsteinCogPsych.pdf>
- A. Maelicke (1990), Vom Reiz der Sinne, VCH
- Steven Heim, The Resonant Interface, Boston: Addison-Wesley. 978-0-321-37596-4. Chapter 14.
- Donald A. Norman, Affordance, conventions, and design, Interactions. Volume 6, Number 3 (1999), Pages 38-41  
[http://www.jnd.org/dn.mss/affordance\\_conv.html](http://www.jnd.org/dn.mss/affordance_conv.html)
- Card, S., Moran, T. & Newell, A. (1983). The Psychology of Human-Computer Interaction. Hillsdale, NJ: Erlbaum.
- Norman, D. A (2003) Emotional Design, ISBN: 0465051359 (Chapter 1)
- Crawford, C. (2002). The Art of Interactive Design. San Francisco: No Starch Press
- Norman, D. A (2008). Signifiers, not affordances. [http://www.jnd.org/dn.mss/signifiers\\_not\\_affordances.html](http://www.jnd.org/dn.mss/signifiers_not_affordances.html)