

# 2. Visual Perception

Optimizing Information Visualization regarding the human visual system



Dr. Thorsten Buring, 25. Oktober 2007, Vorlesung Wintersemester 2007/08

# Outline

- ☰ Perception Definition & Context
- ☰ Preattentive processing
- ☰ Gestalt Laws
- ☰ Change Blindness
- ☰ Data encoding – glyphs
- ☰ Data encoding – color
- ☰ Characteristics of Visual Properties

# Perceptual Processing

- ≡ Design visual information to be efficiently perceivable – quick, unambiguous
- ≡ Need to understand how human visual perception and information processing works
- ≡ Perception science related to:
  - ≡ Physiology: study the physical, biochemical and information processing functions of living organisms
  - ≡ Cognitive psychology: studying internal mental processes – how do people learn, understand, solve problems with regard to sensory information?

# Model of Perceptual Processing

- ≡ Numerous other models exist
- ≡ Simplified 3-stage model: many subsystems involved in human vision
- ≡ **Stage 1** – rapid parallel processing to extract low-level properties of a visual scene
  - ≡ Detection of shape, spatial attributes, orientation, color, texture, movement
  - ≡ Billions of Neurons work in parallel, extracting information simultaneously
  - ≡ Occurs automatically, independent of focus
  - ≡ Information is transitory (though briefly held in a short-lived visual buffer)
  - ≡ Often called “preattentive” processing

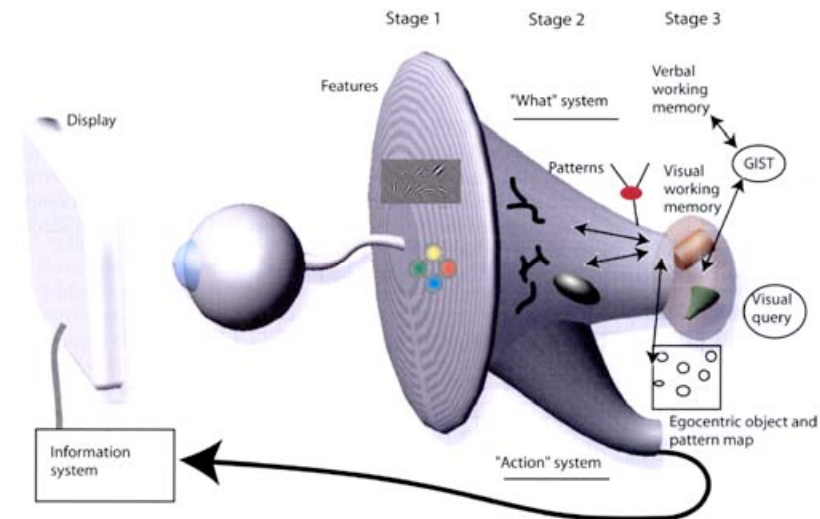

Image taken from Ware 2001

# Model of Perceptual Processing

- ≡ **Stage 2** – pull out structures via pattern perception
  - ≡ Visual field is divided in simple patterns: e.g. continuous contours, regions of the same color / texture
  - ≡ Object recognition
  - ≡ Slower serial processing
- ≡ **Stage 3** – sequential goal-directed processing
  - ≡ Information is further reduced to a few objects held in visual working memory
  - ≡ Used to answer and construct visual queries
  - ≡ Attention-driven - forms the basis for visual thinking
  - ≡ Interfaces to other subsystems:
    - ≡ Verbal linguistic: connection of words and images
    - ≡ Perception-for-action: motor system to control muscle movement

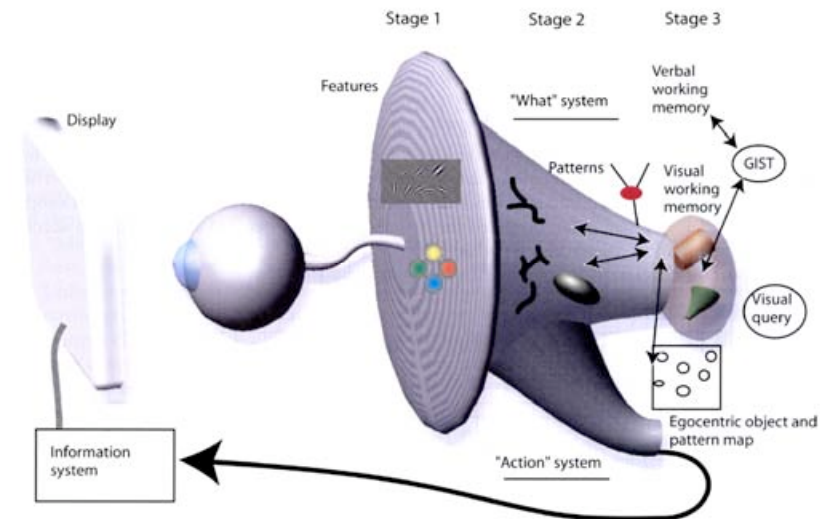
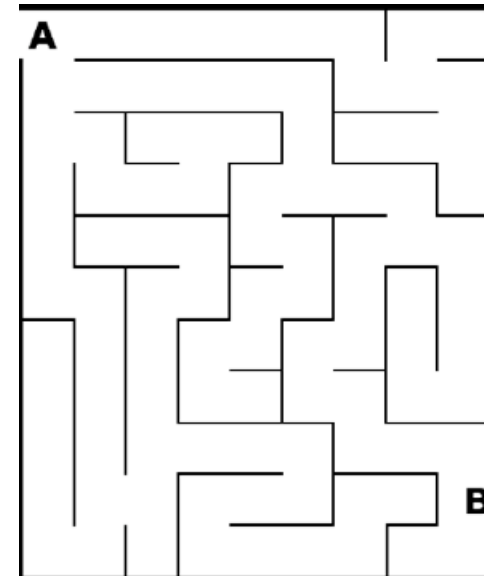

Image taken from Ware 2001

# Example

- ≡ Route between the two letters?
- ≡ Stage 1: automatic parallel extraction of colors, shapes, position etc.
- ≡ Stage 2:
  - ≡ Pattern finding of black contours (lines) between two symbols (letters)
- ≡ Stage 3:
  - ≡ Few objects are held in working memory at a time
  - ≡ Identify path sequentially (formulate new visual query)
- ≡ In this lecture we will focus on aspects related to stage 1 & 2 of the model



# Outline

- ☰ Perception Definition & Context
- ☰ Preattentive processing
- ☰ Gestalt Laws
- ☰ Change Blindness
- ☰ Data encoding – glyphs
- ☰ Data encoding – color
- ☰ Characteristics of Visual Properties

# Preattentive Processing

- ≡ A limited set of basic visual properties are processed preattentively
- ≡ Information that “pops out”
- ≡ Parallel processing by the low-level visual system (Stage 1 in the model)
- ≡ Occurs prior to conscious attention
- ≡ Important for designing effective visualizations
  - ≡ What features can be perceived rapidly?
  - ≡ Which properties are good discriminators?
  - ≡ What can mislead viewers?
  - ≡ How to design information such that it pops out?



# Example: Find the 3s

1424164963575984759217659684748917284822859588198294  
5096850485069584761212404407467489898517149596912456  
7659608020860608365416496457590643980479248576960781  
2859607999187128452681014959691245677818742416496457  
5765960814959691245670128596079916496457512787991871  
2845298496912223591649645759588198250963576596080596

# Example: Find the 3s

142416496**3**575984759217659684748917284822859588198294  
5096850485069584761212404407467489898517149596912456  
7659608020860608**3**65416496457590643980479248576960781  
2859607999187128452681014959691245677818742416496457  
5765960814959691245670128596079916496457512787991871  
284529849691222**3**59164964575958819825096**3**576596080596

# Preattentive Processing

- ≡ How to find out if a visual attribute is preattentive?
- ≡ Measure response time for tasks
  - ≡ Detection of a target among distractors – Is the target present?
  - ≡ Boundary detection – Do items form two groups?
  - ≡ Counting – How many targets are there?
- ≡ Detection of targets on a large multi-element display (Healey)
  - ≡ < 200 to 250 ms are considered preattentive
  - ≡ Eye movement takes at least 200 ms to initiate
- ≡ Example: is there a red target present in the images?

# Color

☰ Is there a red circle present in the image?

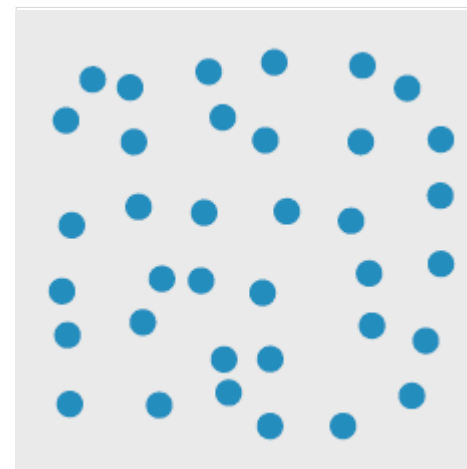
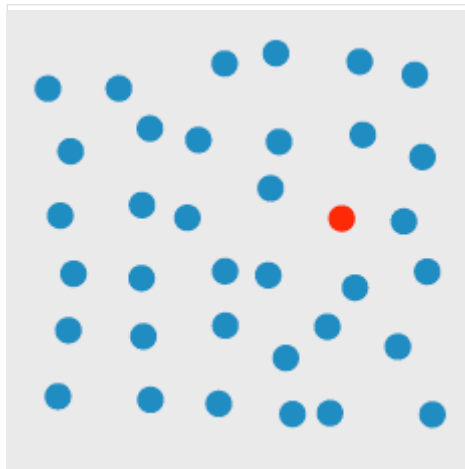

Images taken from <http://www.csc.ncsu.edu/faculty/healey/PP/index.html>

# Color

☰ Is there a red circle present in the image?

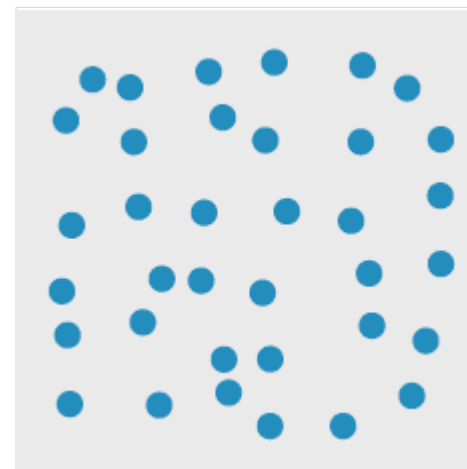
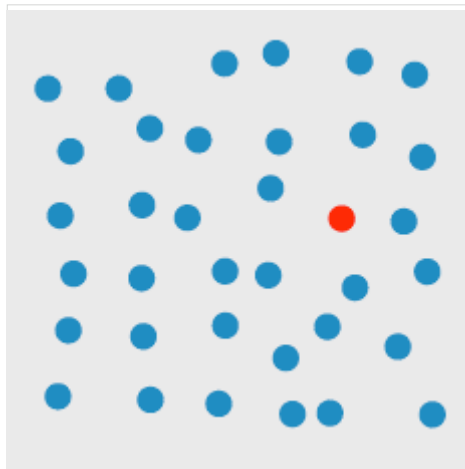

Color is preattentively processed!

Images taken from <http://www.csc.ncsu.edu/faculty/healey/PP/index.html>

# Shape

☰ Is there a red circle present in the image?

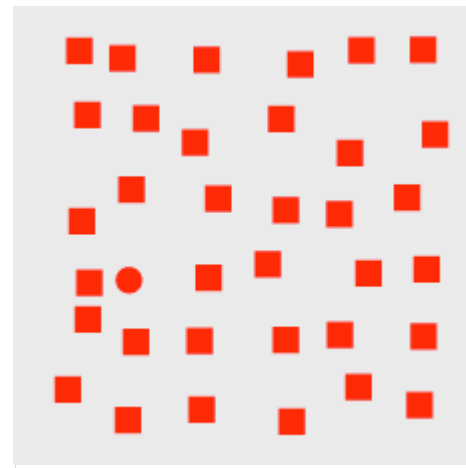
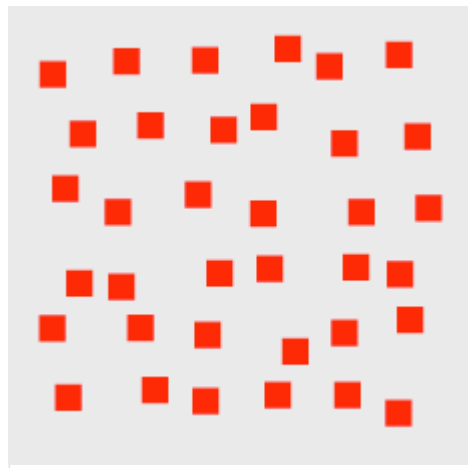

Images taken from <http://www.csc.ncsu.edu/faculty/healey/PP/index.html>

# Shape

☰ Is there a red circle present in the image?

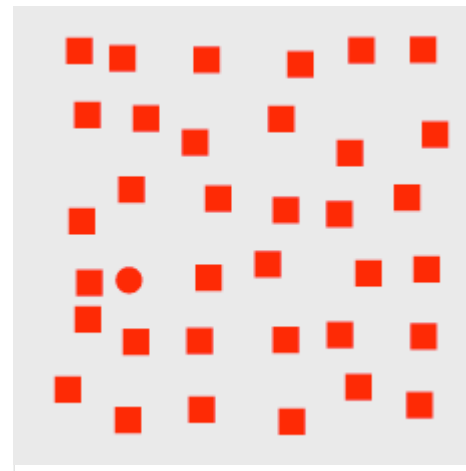
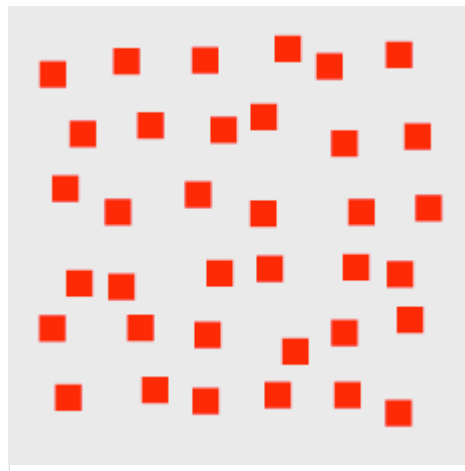

Shape is preattentively processed!

Images taken from <http://www.csc.ncsu.edu/faculty/healey/PP/index.html>

# Color & Shape

☰ Is there a red circle present in the image?

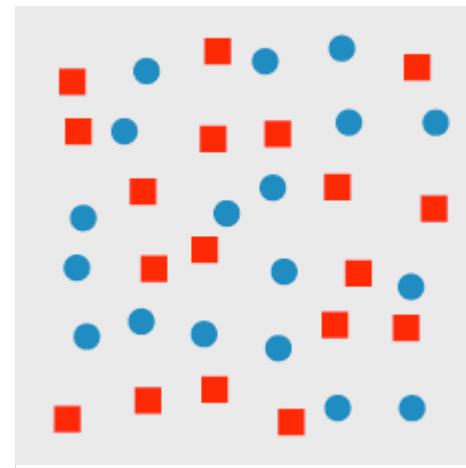
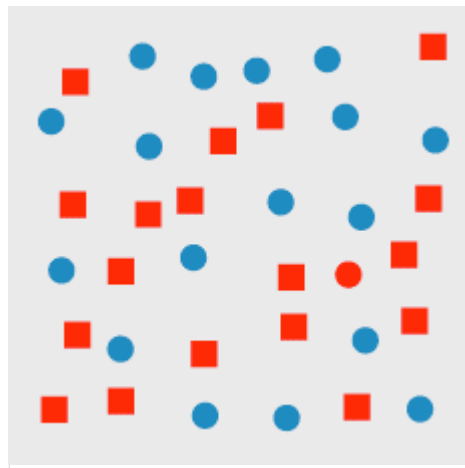

Images taken from <http://www.csc.ncsu.edu/faculty/healey/PP/index.html>



# Color & Shape

☰ Is there a red circle present in the image?

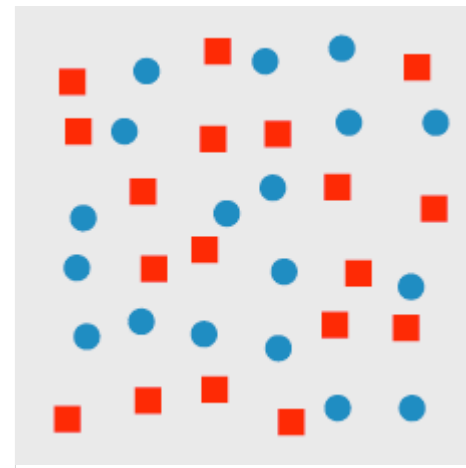
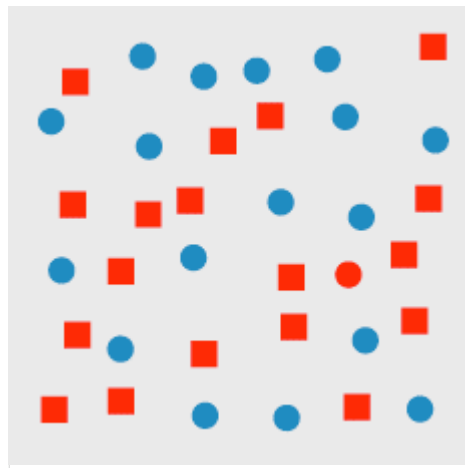

Conjunction search is usually not  
preattentive!

Images taken from <http://www.csc.ncsu.edu/faculty/healey/PP/index.html>

# Boundary Detection

☰ Do items form a boundary? If yes, based on which attribute(s)?

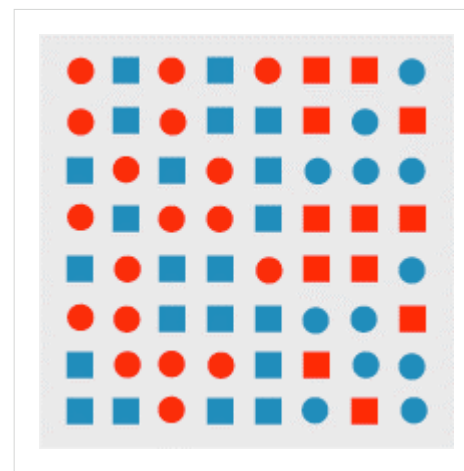
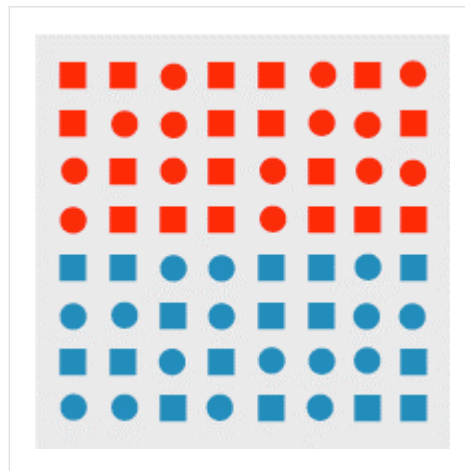

Images taken from <http://www.csc.ncsu.edu/faculty/healey/PP/index.html>

# Boundary Detection

☰ Do items form a boundary? If yes, based on which attribute(s)?

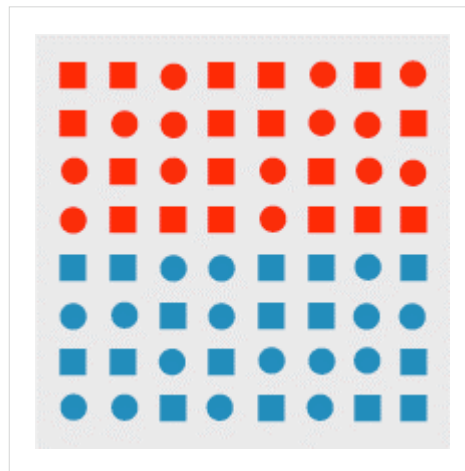

Preattentive: grouping by  
hue

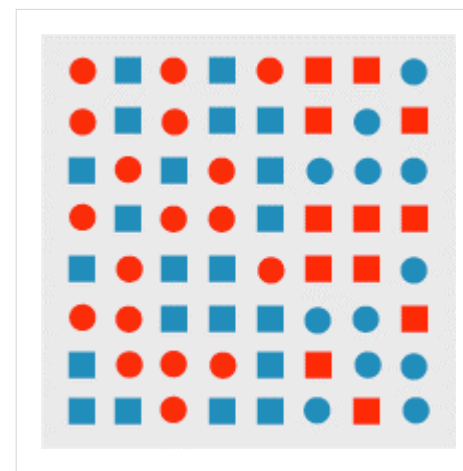

Conjunction search:  
grouping by hue and shape

Images taken from <http://www.csc.ncsu.edu/faculty/healey/PP/index.html>

# Common Preattentive Properties

## ≡ Form

- ≡ Line orientation
- ≡ Line length
- ≡ Line width
- ≡ Size
- ≡ Curvature
- ≡ Shape
- ≡ Spatial grouping
- ≡ Bur

## ≡ Color

- ≡ Hue
- ≡ Intensity

## ≡ Motion

- ≡ Flicker
- ≡ Direction of motion

## ≡ Spatial Position

- ≡ 2D position
- ≡ Stereoscopic depth
- ≡ Convexity / Concavity

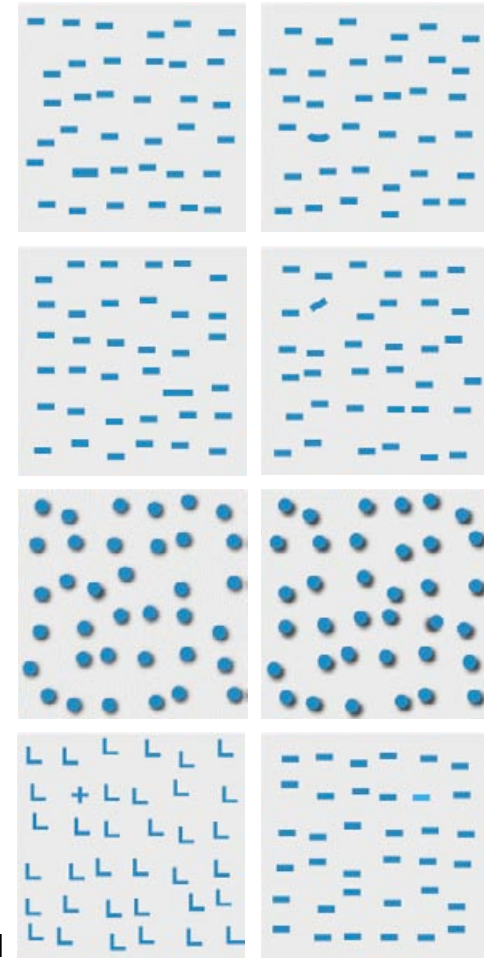

Images taken from <http://www.csc.ncsu.edu/faculty/healey/PP/index.html>

# Conjunction Search

- ≡ A target with a unique visual property (e.g. shape OR color) “pops out”
- ≡ Conjunction target is made up of non-unique features
- ≡ Requires a time-consuming serial search, e.g.
  - ≡ For every red colored item: is it a circle?
  - ≡ For every circular item: is it red?
- ≡ Exception: preattentive conjunctions involving:
  - ≡ Motion
  - ≡ Depth
  - ≡ Color
  - ≡ orientation

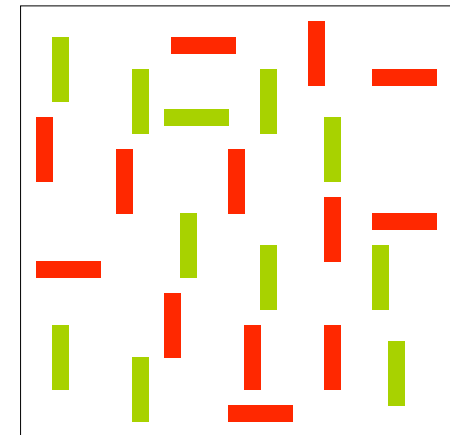
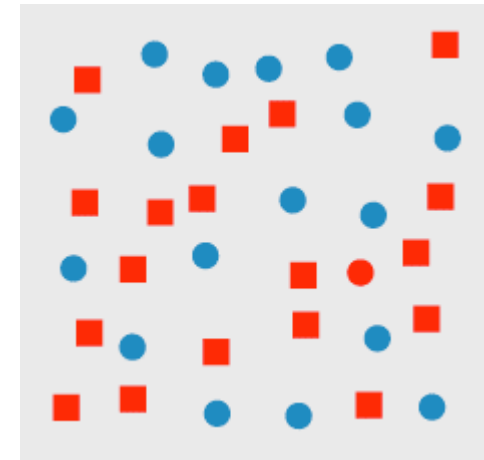

# Outline

- ☰ Perception Definition & Context
- ☰ Preattentive processing
- ☰ Gestalt Laws
- ☰ Change Blindness
- ☰ Data encoding – glyphs
- ☰ Data encoding – color
- ☰ Characteristics of Visual Properties

# Cognition and Gestalt Laws

- ≡ Recap: step 2 of the visual information processing model – pattern and object recognition using the raw data collected in step 1
- ≡ Based on which visual properties do we structure the data?
- ≡ Gestalt school of psychology founded in 1912 formulated Gestalt laws
- ≡ “The whole is greater than the sum of parts” (Koffka 1935)
- ≡ Laws still useful today, but not the neural mechanisms proposed
- ≡ Perception: An introduction to the Gestalt-theorie (Kurt Koffka, 1922):  
<http://psychclassics.yorku.ca/Koffka/Perception/perception.htm>

# What do you see?

- ≡ Can you find the dog?
- ≡ Dalmatian exploring a leaf covered forest floor
- ≡ Once you have found it, try to think of the picture as a simple pattern of black and white again
- ≡ Does it work?
- ≡ Mind tries to detect anything meaningful by identifying patterns
- ≡ Different tools are tried sequentially
- ≡ Perceptual organization is a powerful mechanism





# GL: Grouping by Spatial Proximity

- ≡ Columns or rows?
- ≡ Small difference in spacing causes change in perception
- ≡ Use proximity to emphasize between display items
- ≡ To which group (top / bottom) does the x dot belong? Spacing is equal for both groups!
- ≡ Spatial concentration principle: we group regions of similar element density (Slocum1983)

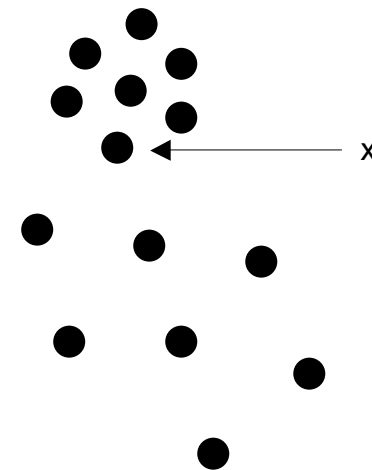
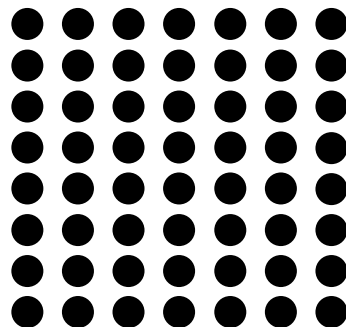
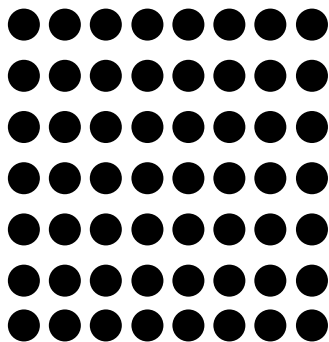

# GL: Similarity

☰ Rows or columns?

☰ Similar elements tend to be grouped together

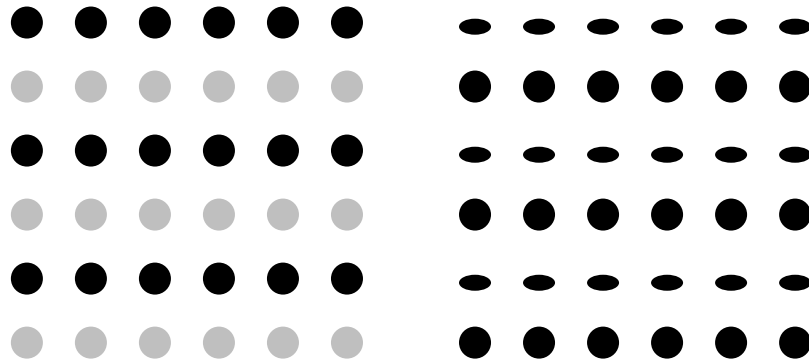

# GL: Connectedness

≡ Palmer & Rock 1994

≡ Potentially more powerful organizing principle than proximity, color, size, shape

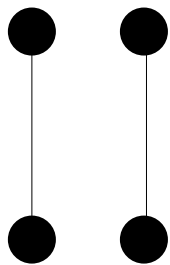

proximity

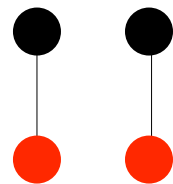

color

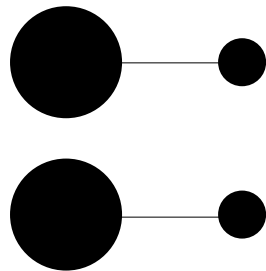

size

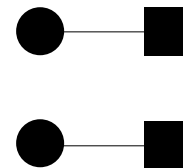

shape



Example: node-link diagram

# GL: Continuity

- ≡ Smooth and continuous visual elements are likely to be perceived as an entity
- ≡ Abrupt changes in direction create the opposite effect
- ≡ What are the two shapes the figure is assembled from?

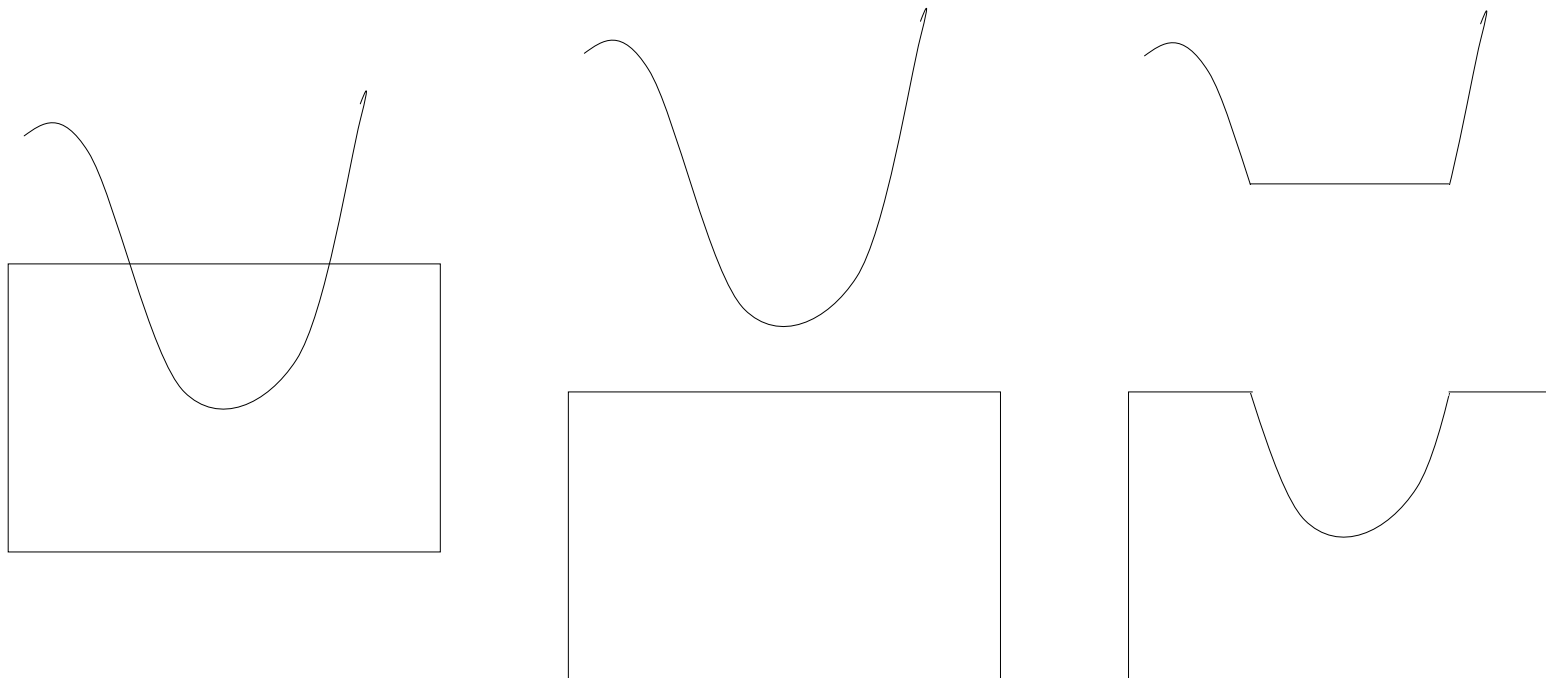

# GL: Continuity

≡ Example circuit design - understanding how components are connected

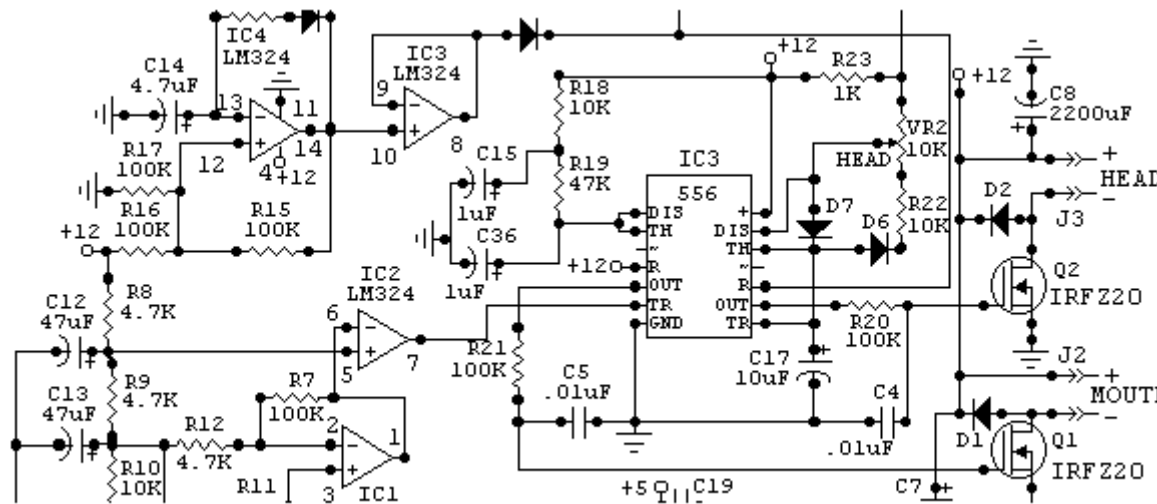

# GL: Symmetry

- ≡ Symmetric forms are perceived much more as a holistic figure
- ≡ Symmetry makes us see a cross in front of a rectangle

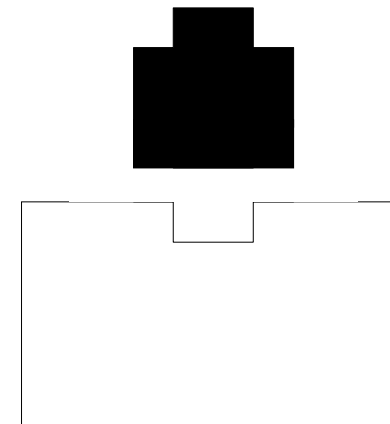
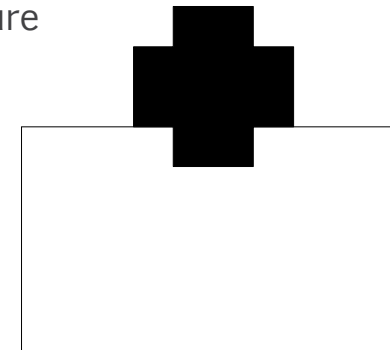
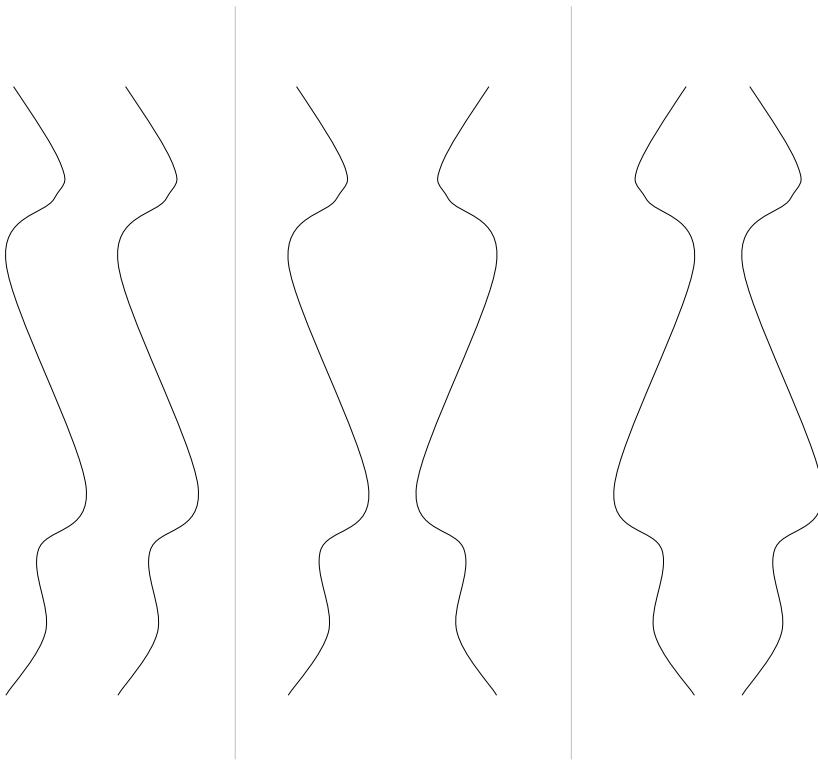

# GL: Symmetry

- ≡ Example of how symmetry detection may be exploited for visual data mining
- ≡ Support the search for similar patterns in time-series plots (measurements of deep ocean drilling cores)

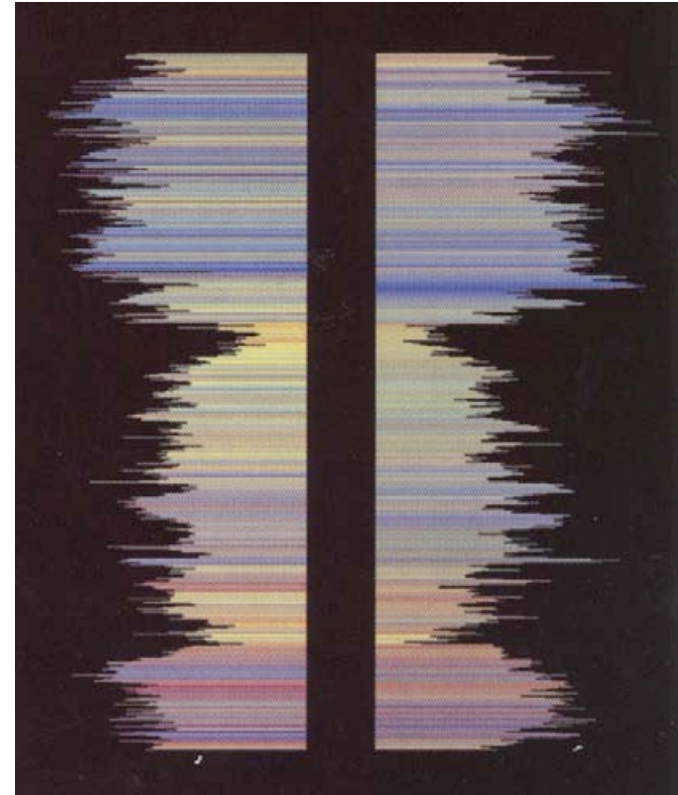
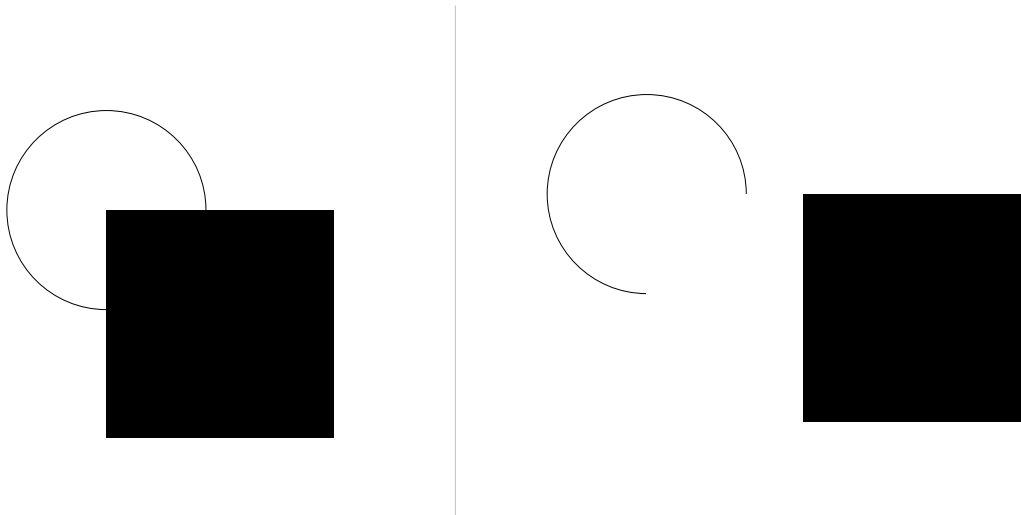
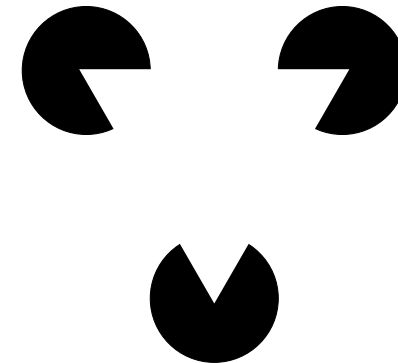

Image taken from Ware 2001

# GL: Closure

- ≡ We see a closed contour as an object
- ≡ Tendency to close contours that have gaps
- ≡ Mind reacts to patterns that are familiar
- ≡ Illusory contours





# GL: Area

- ≡ Smaller components of a pattern tend to be perceived as an object
- ≡ White propeller and black propeller

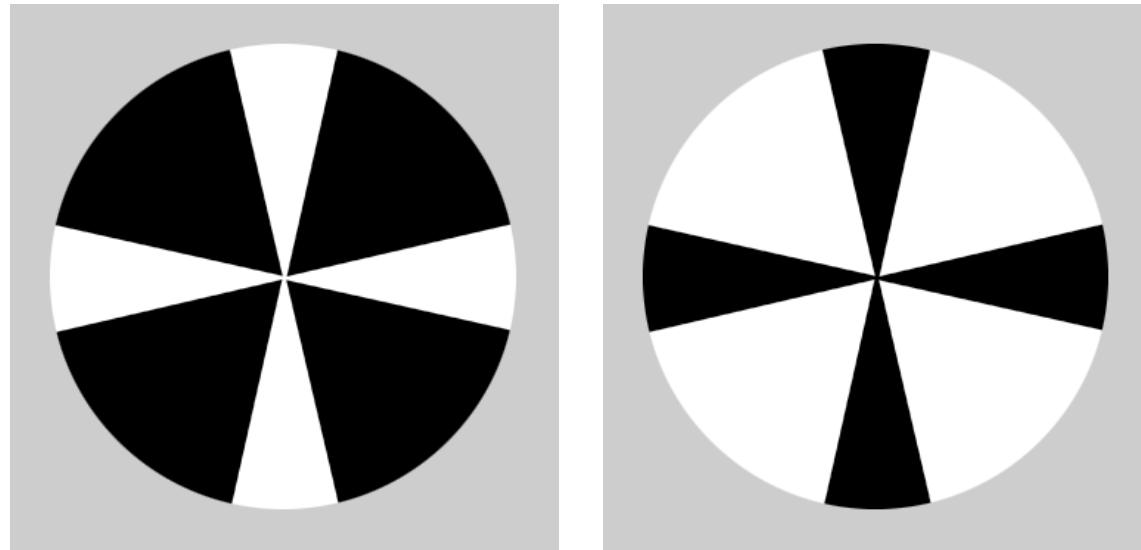

# GL: Figure & Ground

- ≡ Figure: something object-like that is perceived being in the foreground
- ≡ Ground: whatever lies behind the figure
- ≡ Fundamental perceptual act of identifying objects
- ≡ All Gestalt laws contribute, e.g. in upper image: closed contour, symmetry, area
- ≡ Equally balanced cues for figure and ground can result in bistable perception

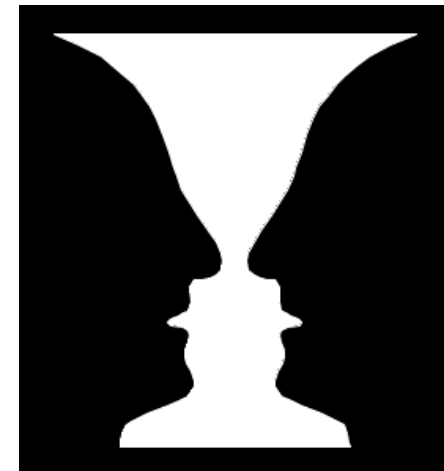
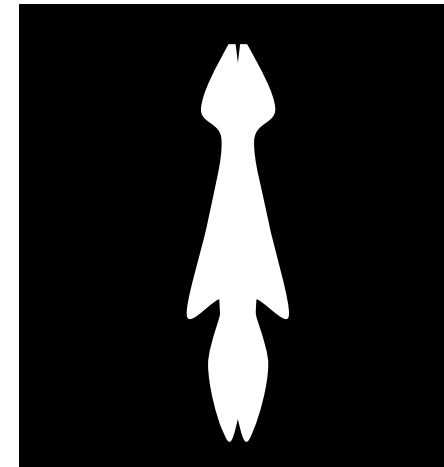

# GL: Common Fate

- ≡ Objects moving in the same direction are perceived as an entity
- ≡ Example taken from: <http://tepservers.ucsd.edu/~jlevin/gp/time-example-common-fate/>

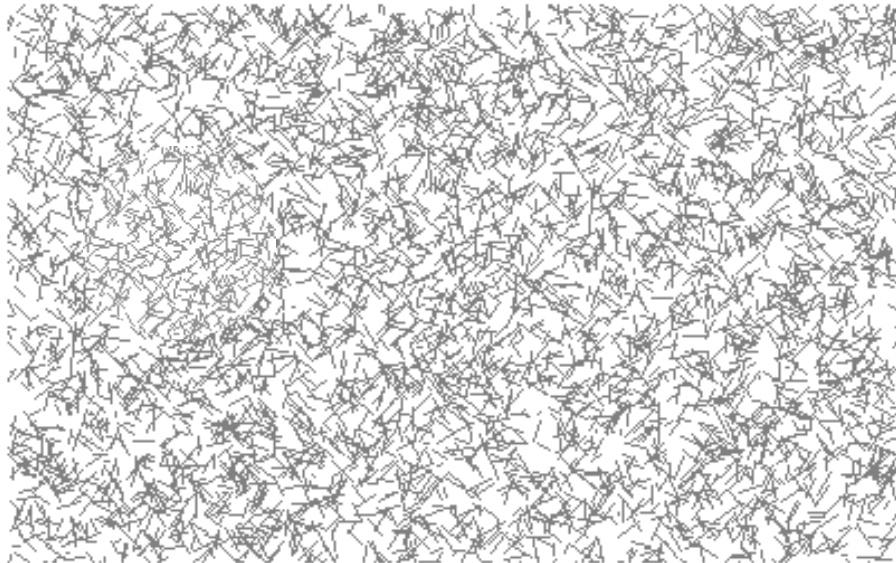

# Outline

- ☰ Perception Definition & Context
- ☰ Preattentive processing
- ☰ Gestalt Laws
- ☰ Change Blindness
- ☰ Data encoding – glyphs
- ☰ Data encoding – color
- ☰ Characteristics of Visual Properties

# Change Blindness (CB)

- ≡ Example: old style aircraft altimeter
  - ≡ Thinnest hand indicates number of tens of thousands of feet
  - ≡ Next larger hand number of thousands of feet
  - ≡ Quick glance after interruption results in misinterpretation if the change in the display is not noticed
  - ≡ Difference of ten thousand feet
- ≡ Phenomenon: inability to detect changes in visual scenes
  - ≡ mid-eye movement
  - ≡ mid-blink
  - ≡ Flicker (short blanking of screen)
  - ≡ Gradual change



# Change Blindness (CB)

- ≡ Participants of a study were found unable to detect a change from one person to another in midconversation (Simson & Levin 1998)
- ≡ Sample principle: insensitivity to changes of objects in movie scenes interrupted by a cut (Levin & Simons 1997)
- ≡ Various examples:  
[http://viscog.beckman.uiuc.edu/djs\\_lab/demos.html](http://viscog.beckman.uiuc.edu/djs_lab/demos.html)
- ≡ Problem related to the short-lived visual buffer and the very limited capacity of our visual working memory
- ≡ Need to emphasize changes
- ≡ In some applications changes may be distracting, e.g. ambient information visualization -> utilize CB



Levin & Simons 1997

# CB: Flicker Example 1



<http://www.csc.ncsu.edu/faculty/healey/PP/index.html>

# CB: Flicker Example 2





# CB: Gradual Change Example



# CB Resources

- ≡ Various theories about CB, see for instance  
[http://cvcl.mit.edu/IAP05/Simons\\_2000a.pdf](http://cvcl.mit.edu/IAP05/Simons_2000a.pdf)
- ≡ [http://viscog.beckman.uiuc.edu/djs\\_lab/demos.html](http://viscog.beckman.uiuc.edu/djs_lab/demos.html)
- ≡ <http://viscog.beckman.uiuc.edu/change/demolinks.shtml>
- ≡ Visual Perception Phenomena
  - ≡ Demonstrator tool: Visuelle Welt, Prof. Dr. Ronald Hübner
  - ≡ <http://www.uni-konstanz.de/psychologie/ag-kog/viswog.htm>

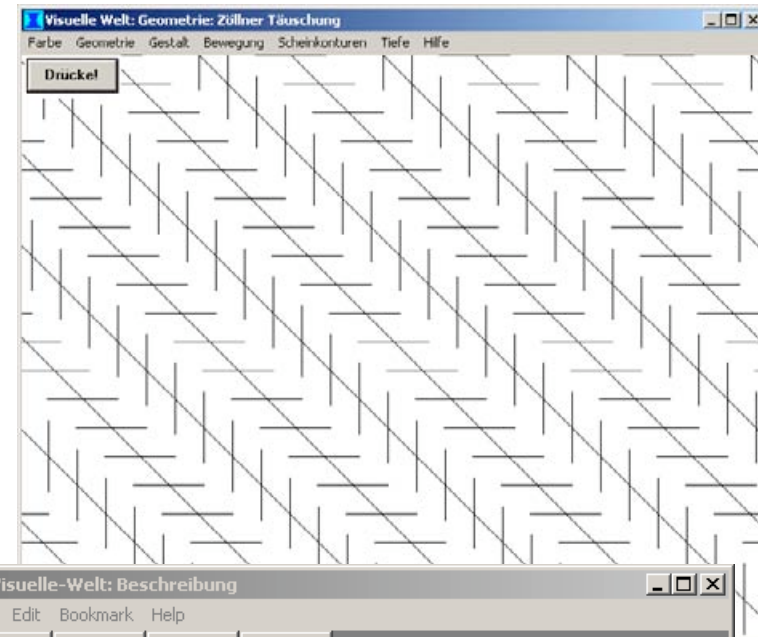

**Geometrie: Zöllner-Täuschung**

Die Zöllner-Täuschung ist eine *Orientierungstäuschung*. Die schrägen Linien scheinen unterschiedliche Orientierungen zu haben. Läßt man aber durch Anklicken der Kontrolltaste die kurzen horizontalen und vertikalen Striche verschwinden, dann sieht man, daß die schrägen Linien parallel verlaufen.

Zöllner, F. (1860). Über eine neue Art von Pseudoskopie und ihre Beziehungen zu den von Plateau und Opperl beschriebenen Bewegungsphänomenen. *Poggendorff's Annalen der Physik und Chemie*, **110**, 500-523.

# Outline

- ☰ Perception Definition & Context
- ☰ Preattentive processing
- ☰ Gestalt Laws
- ☰ Change Blindness
- ☰ Data encoding – glyphs
- ☰ Data encoding – color
- ☰ Characteristics of Visual Properties

# Encoding Data with Glyphs

- ≡ Glyph: graphical object designed to convey multiple data values
- ≡ Multidimensional discrete data, e.g. a collection of cars with several attributes each, e.g. horsepower, weight, acceleration etc.
- ≡ What visual properties can be mapped to the attributes?
- ≡ FilmFinder example
  - ≡ Color to film genre
  - ≡ X-position to year of release
  - ≡ Y-position to popularity
- ≡ Additional properties
  - ≡ Lightness
  - ≡ Shape
  - ≡ Orientation
  - ≡ Texture
  - ≡ Motion
  - ≡ Blinking

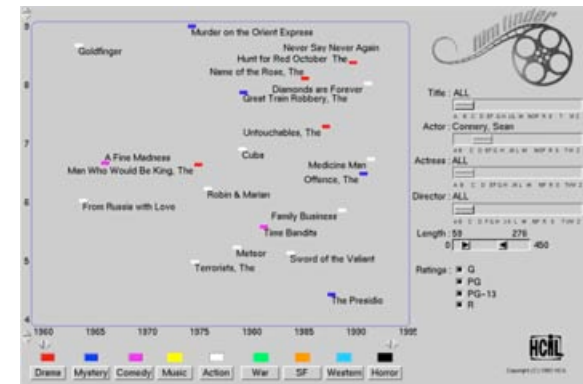

FilmFinder ([www.cs.umd.edu/](http://www.cs.umd.edu/))

# Encoding Data with Glyphs

- ≡ Limitations of low-level graphical attributes for glyph design
- ≡ Easily resolvable steps of a visual property
  - ≡ 12 colors (for preattentive processing only 8 colors)
  - ≡ About 4 orientation steps
  - ≡ At most 4 size steps
  - ≡ Binary blink coding (on / off)
  - ≡ Texture unknown
  - ≡ Shape unknown
- ≡ Mixing visual properties
  - ≡ Properties are not independent from each other, e.g. blink coding interferes with motion coding
  - ≡ Conjunctions are usually non-preattentive
  - ≡ Some dimensions are **integral**
  - ≡ Best to restrict the mapping to color, shape, spatial position (and motion)
- ≡ Denotes the need for interaction to enable dynamic glyph encoding

# Integral & Separable Dimensions

- ≡ Problem when designing glyphs: perceptual dependency of visual properties
- ≡ Example:
  - ≡ Does color interfere with shape when representing two variables?
- ≡ Concept of integral vs. separable dimensions (Garner 1974)
  - ≡ Integral dimensions: two or more properties of a visual object are perceived holistically (dependency), e.g. width and height of a rectangle
  - ≡ Separable dimensions: properties are perceived as independent, allows for separate judgment of the properties, e.g. size and color
- ≡ How to classify visual properties?
- ≡ Evaluation via restricted classification tasks

# Restricted Classification Task

- ≡ Sets of three glyphs
- ≡ Two of the glyphs are identical on one variable (A and B)
- ≡ Third glyph C is closer to B in feature space, but is different to the other glyphs in both dimensions
- ≡ Evaluation task: group by similarity
- ≡ Integral dimensions: B and C are grouped together (closer in feature space)
- ≡ Separable dimensions: A and B are grouped together (identical values for one dimension)

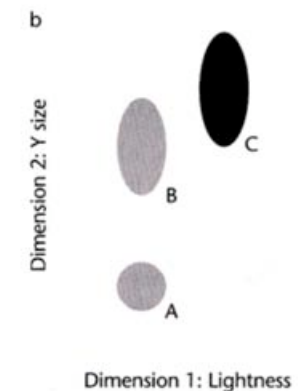
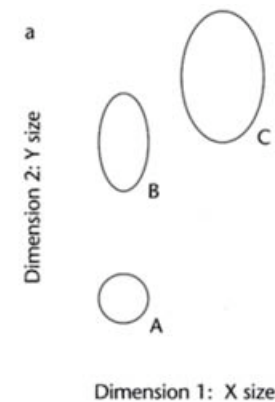
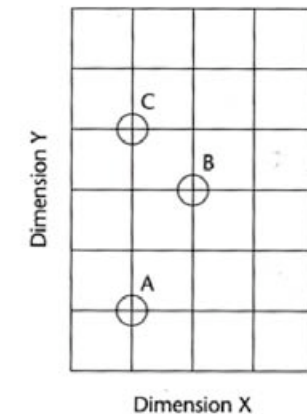
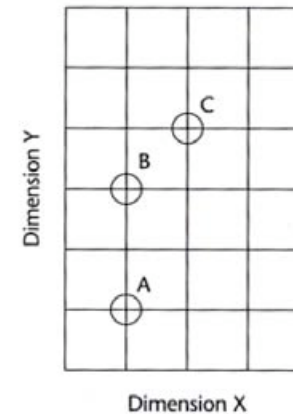

Ware 2004

# Integral & Separable Dimensions

- ≡ Visual properties are never fully separable
- ≡ Concept nevertheless provides a useful and simple design guideline
- ≡ List pairs of visual properties ordered in an integral-separable continuum

Integral dimension pairs

↑  
↓

Separable dimension pairs

Red-green	Yellow-blue
Red-green	Black-white
Shape height	Shape width
Shape	Size
Color	Size
Direction of motion	Shape
Color	Shape
Color	Direction of motion
XY position	Size, shape, or color

Examples:

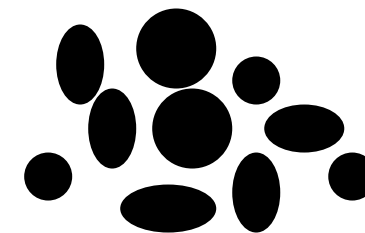

X-size | Y-size



Color | Shape

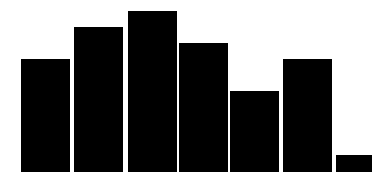

X-position | Height  
= bar chart



# Outline

- ☰ Perception Definition & Context
- ☰ Preattentive processing
- ☰ Gestalt Laws
- ☰ Change Blindness
- ☰ Data encoding – glyphs
- ☰ Data encoding – color
- ☰ Characteristics of Visual Properties

# Color Vision & Model

- Human color vision
  - Sensory response to electromagnetic radiation in the spectrum 0.4 - 0.7 micrometers
  - Based on three dimensions (three different types of color receptors in human retina)
- Powerful encoding potential: compared to gray scales the number of just noticeable differences is much higher
- About 10% of the male and 1% of the female population are color-blind
- Color Model HSV (aka HSB)
  - Hue - blue, green, etc. (X axis)
  - Saturation - intensity of color (Y axis)
  - Value - light/dark (slider)

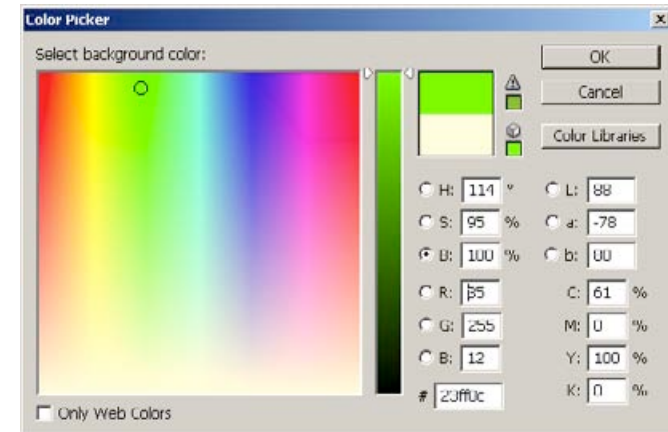

HSV 2D color picker

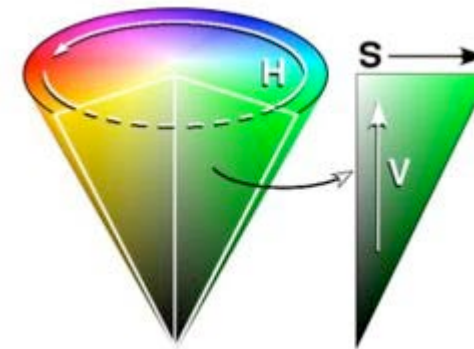

HSV cone representation

# Color Scales

- ≡ Definition: pictorial representation of a set of distinct categorical or numerical values, where each value is assigned its own color (Levkovitz 1996)
- ≡ Desired properties of perception
  - ≡ Preserve the order of the data values, if any
  - ≡ Uniform distance between adjacent values (i.e. equally spaced numerical steps are perceived as equally spaced perceptual steps)
  - ≡ No artificial boundaries that do not exist in the data (i.e. continuously present continuous values)

# Color Rules I

- Always ensure a reasonable luminance contrast between foreground and background color – chromatic variation may not enough!
- Always ensure a reasonable luminance contrast between foreground and background color – chromatic variation may not enough!
- Black and white borders around colored symbols can reduce contrast effects
- Canonical colors (close to an ideal) are easier to remember
- Only a small set of basic colors should be used for nominal (distinct) labeling
  - At most 12 colors: red, green, yellow, blue, black, white, pink, cyan, gray, orange, brown, purple
  - The first four colors are “hard-wired” into the human brain – should be used with priority

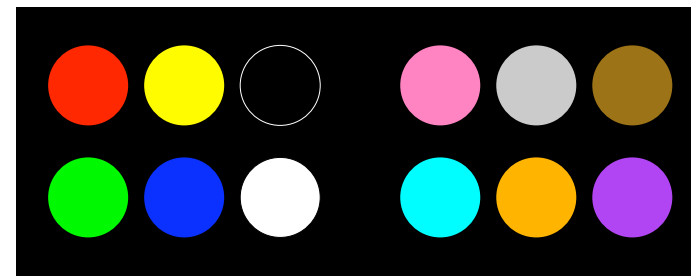
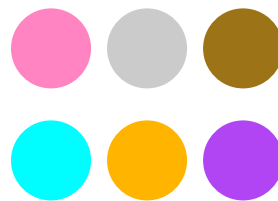
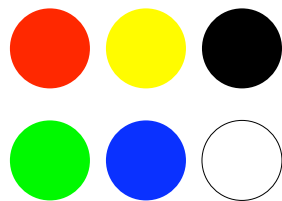

# Grayscale

- ≡ Usually not considered a color scale, but very common
- ≡ Provides simple and natural sense of order
- ≡ Disadvantages
  - ≡ Limited number of just-noticeable-differences (JNDs) of about 60 to 90
  - ≡ Contrast effects can significantly reduce accuracy
  - ≡ Luminance channel is fundamental to much of perception – grayscale encoding may be considered “*a waste of perceptual resources*” (Ware, 2000)
- ≡ Rather not use



# Rainbow for Ordering Data?

## ☰ Most common: rainbow scale for ordinal and quantitative (spectral colors)

☰ Continuous spectrum



☰ Common arbitrary division in 8 or less named colors (red, orange, yellow, green, cyan, blue, indigo, violet)

## ☰ Problems with rainbow scale

☰ Can you order the color blocks from low to high?

☰ Yellow (in the middle of the scale) may draw too much attention, when users are seeking for extreme values

☰ Perception of non-existing boundaries

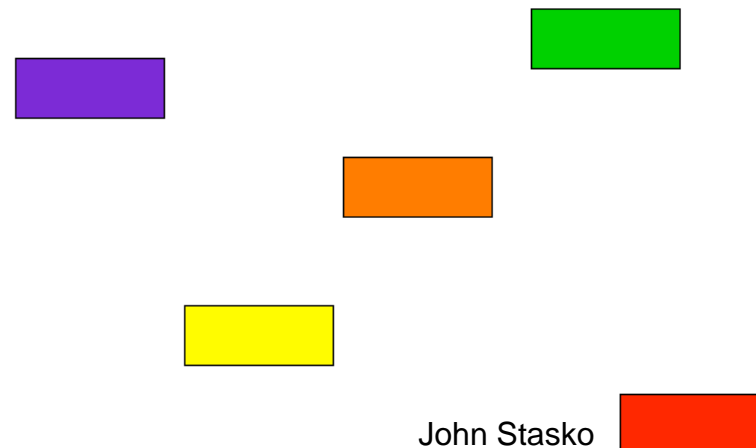

# Recommended Color Scales

## ≡ Ordinal data

- ≡ Low saturation to high saturation (single hue) - also very limited JNDs
- ≡ Dark to light (single hue)
- ≡ Red to green, yellow to blue, red to blue

## ≡ Ratio (hardly feasible) / diverging data

- ≡ Neutral value (e.g. white) to represent zero
- ≡ Increases in saturation toward distinct colors for positive and negative values (double-ended multiple hue)

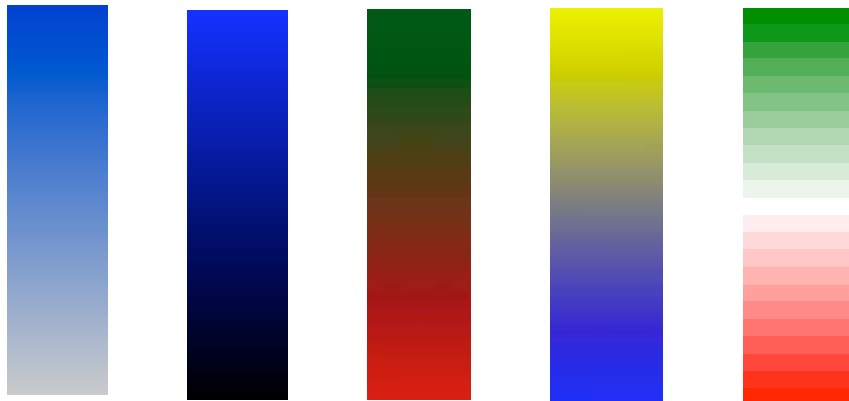

# Redundant Color Scales

- ≡ Use multiple color properties to redundantly represent data
- ≡ Visual reinforcement of steps
- ≡ Overcome visual deficiencies
- ≡ Redundant model components: data values are mapped to both hue and brightness
- ≡ Heated-object scale
  - ≡ Going from black to white passing through orange and yellow
  - ≡ Monotonic increase in brightness provides more natural ordering than rainbow scale
- ≡ Linearized optimal color scale
  - ≡ Scale maximizing the number of JNDs while preserving a (more or less) natural order

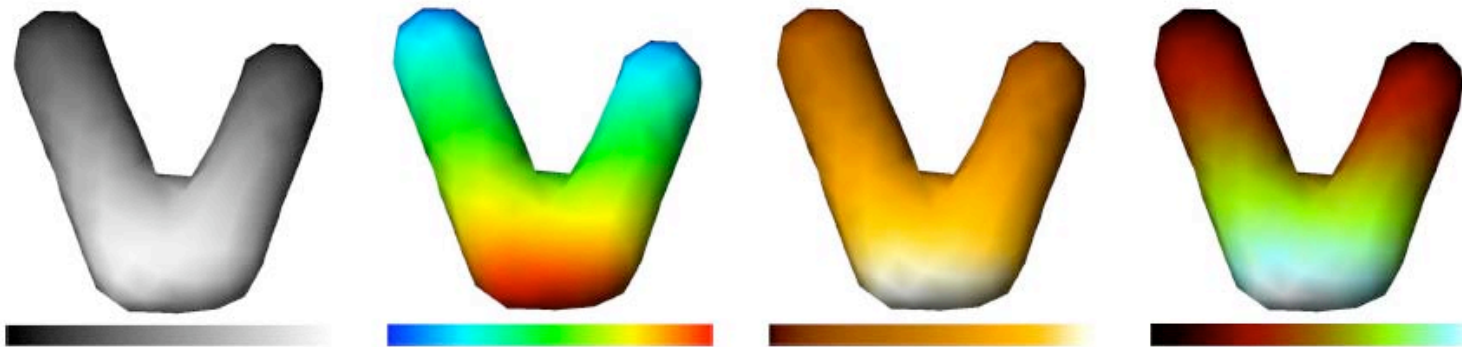

Silva et al. 2007



# Color Scale

≡ US presidential elections - Bush & RNC's campaign funding



<http://fundrace.huffingtonpost.com/moneymap.php?cand=Bush&zoom=County>

# Color Scale

- ≡ Vote distribution of 2004 US presidential election - the darker the color, the more of a landslide it was for the winning party

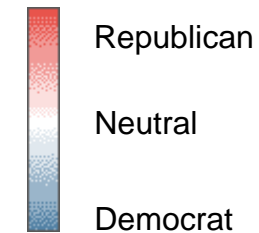
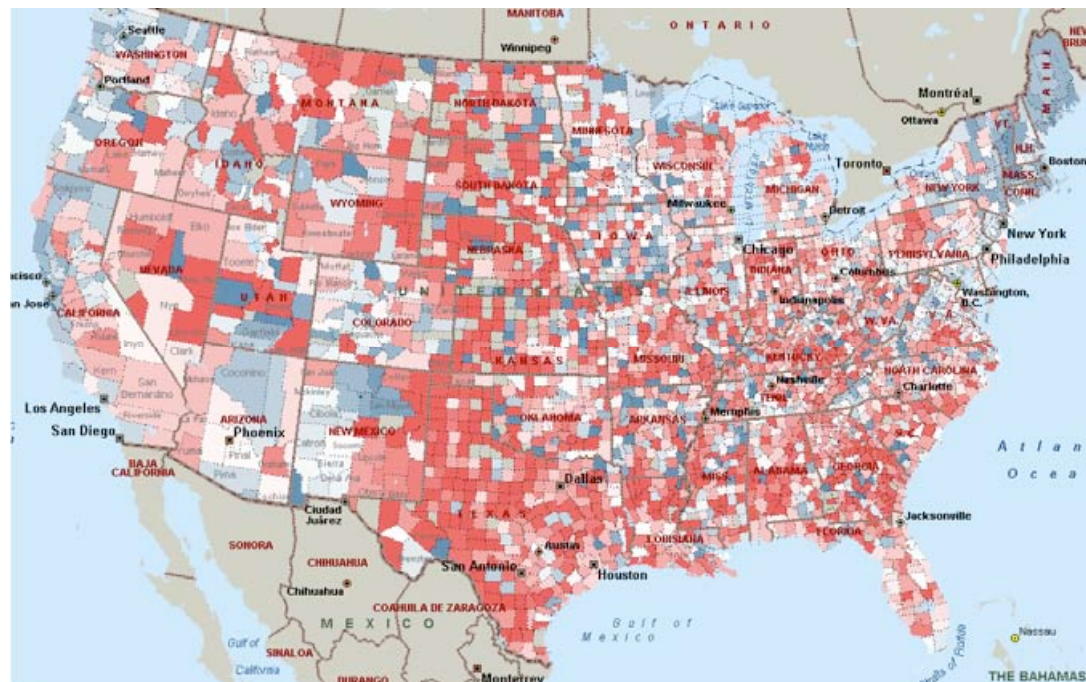

<http://fundrace.huffingtonpost.com/moneymap.php>

# Color Scale

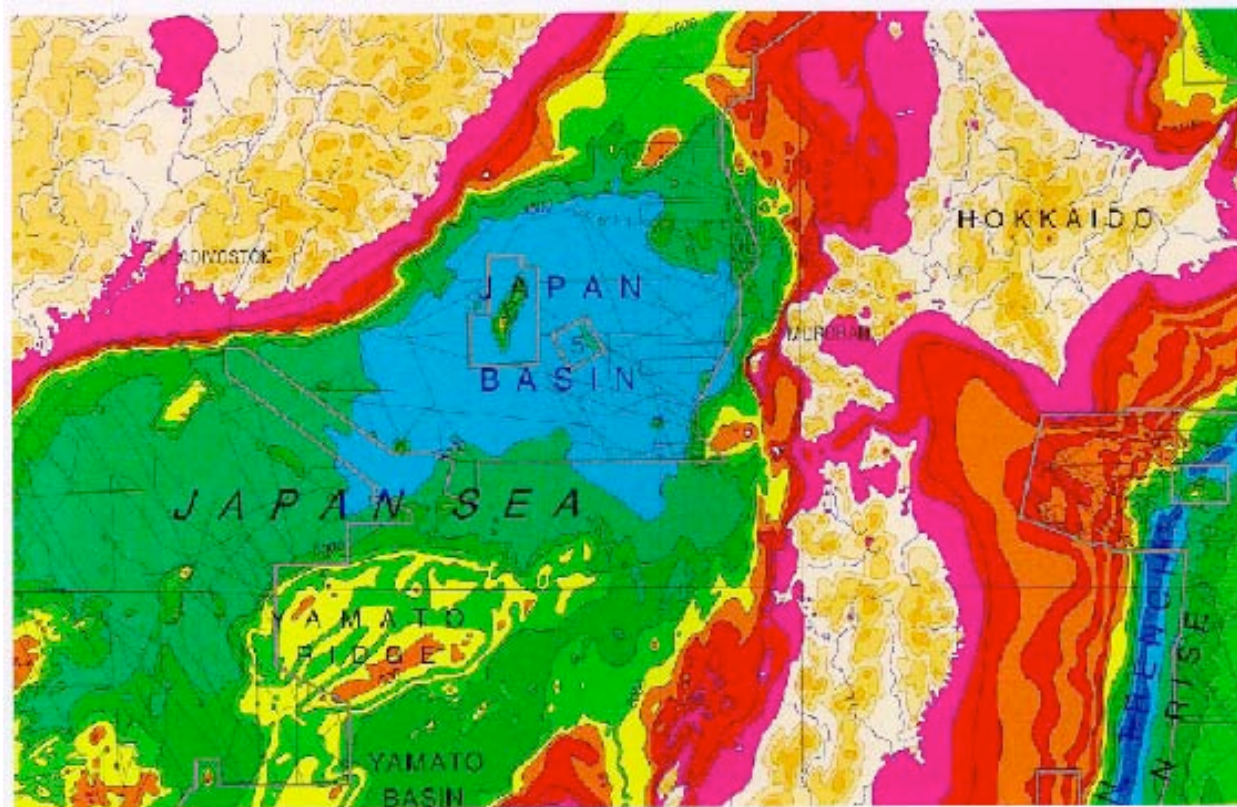

Sheelagh Carpendale

# Color Scale

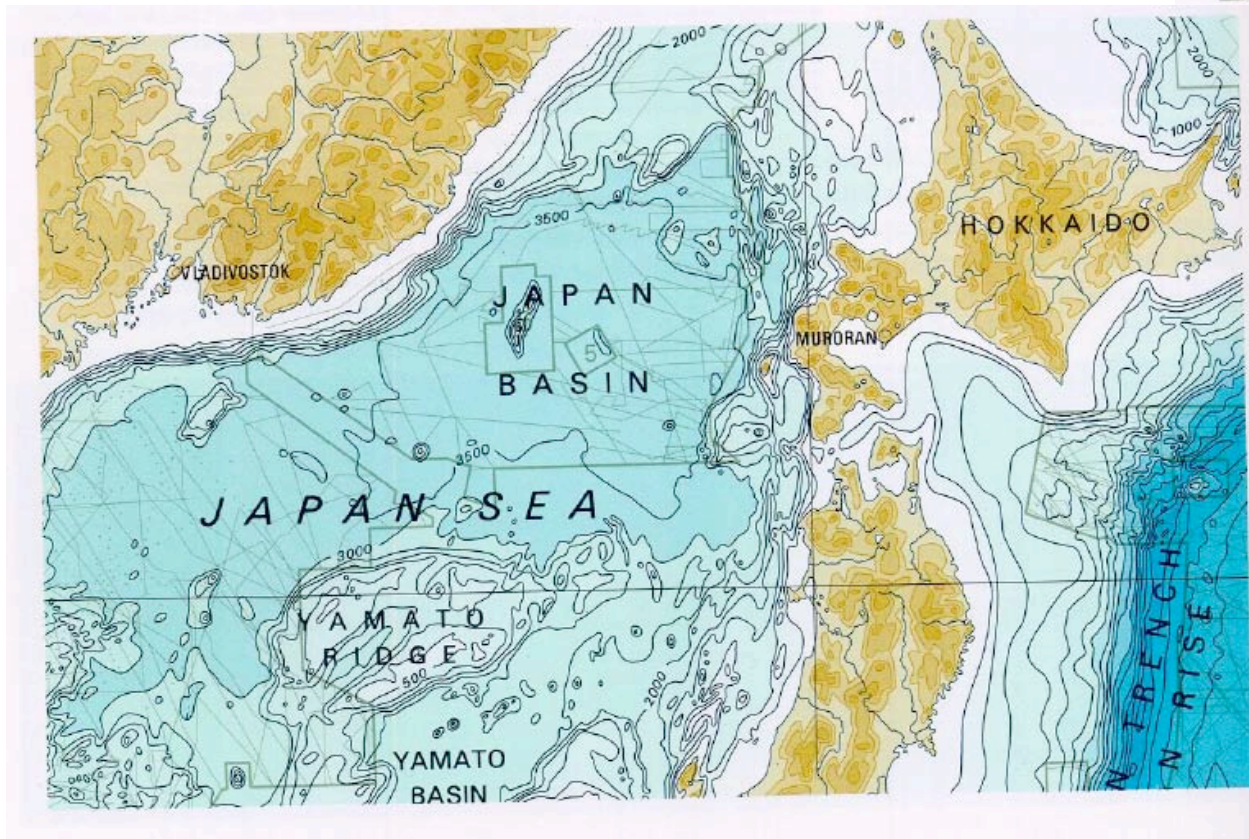
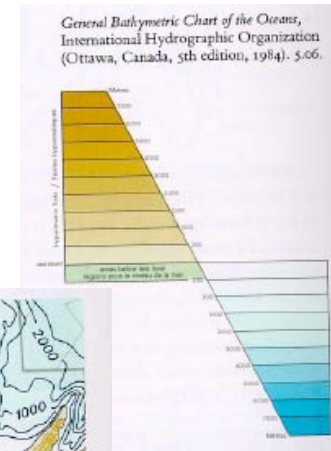

Sheelagh Carpendale

# Color Tools

- ≡ ColorBrewer: generates color palettes based on data type and number of classes
- ≡ <http://www.personal.psu.edu/cab38/ColorBrewer/ColorBrewer.html>
- ≡ More complex tool: ColorMap applet: <http://infovis.uni-konstanz.de/tools/colormap/index.html>

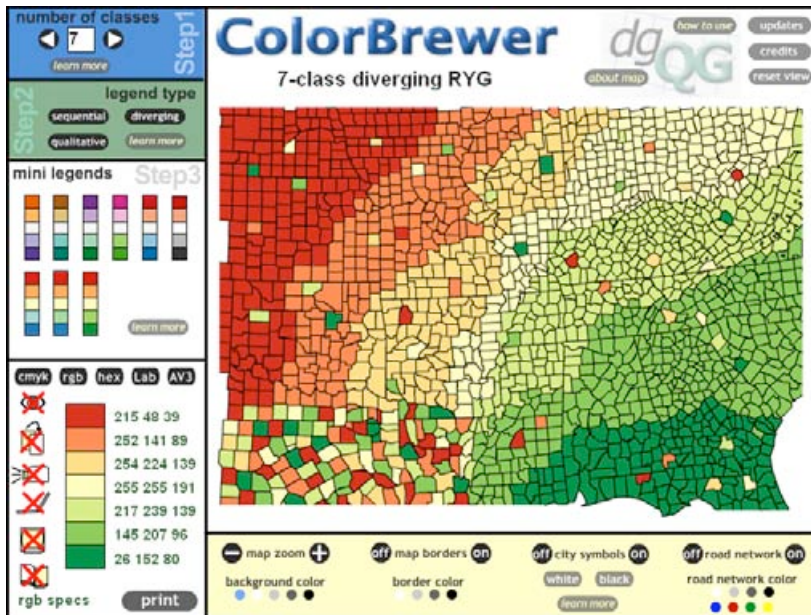

**ColorBrewer** dg QG

7-class diverging RYG

number of classes: 7

legend type: sequential, diverging, qualitative

mini legends

cmk	rgb	hex	Lab	AVJ
	215 48 09			
	252 141 89			
	254 224 139			
	255 255 191			
	217 239 139			
	145 207 96			
	26 152 80			

map zoom, map borders, city symbols, road network, background color, border color, white, black, road network color

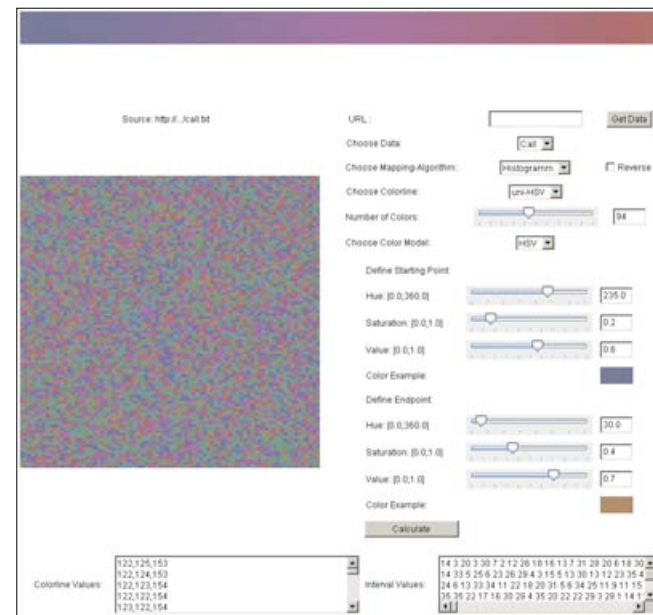

Source: <http://.html>

URL:  Get Data

Choose Data: Cat

Choose Mapping Algorithm: histogram Reverse

Choose Colorline: uns+HSV

Number of Colors: 94

Choose Color Model: HSV

Define Starting Point

Hue (0,360): 225.0

Saturation (0,1.0): 0.2

Value (0,1.0): 0.8

Color Example:

Define Endpoint

Hue (0,360): 30.0

Saturation (0,1.0): 0.4

Value (0,1.0): 0.7

Color Example:

Calculate

Colorline Values: 122,125,153; 122,124,153; 122,123,154; 122,122,154; 122,122,154

Interval Values: 14 3 20 3 30 7 2 12 26 18 16 13 7 31 28 20 6 18 30; 14 33 5 25 6 23 26 29 4 3 15 5 13 30 13 12 23 35 4; 24 6 12 33 34 11 22 19 20 31 5 8 34 25 11 9 11 15; 35 35 22 17 18 30 29 4 35 20 22 22 29 3 28 1 14 1

# Application example

- ≡ Nasdaq - diverging data encoded by color:  
[http://screening.nasdaq.com/heatmaps/heatmap\\_100.asp](http://screening.nasdaq.com/heatmaps/heatmap_100.asp)
- ≡ Price of companies in the NASDAQ-100 Index at a glance
- ≡ Green means stock price is up
- ≡ Red means stock price is down
- ≡ The more saturated a color is, the bigger the move
- ≡ Red-green sequence has been found most effective (Spence & Efendor, 2001)

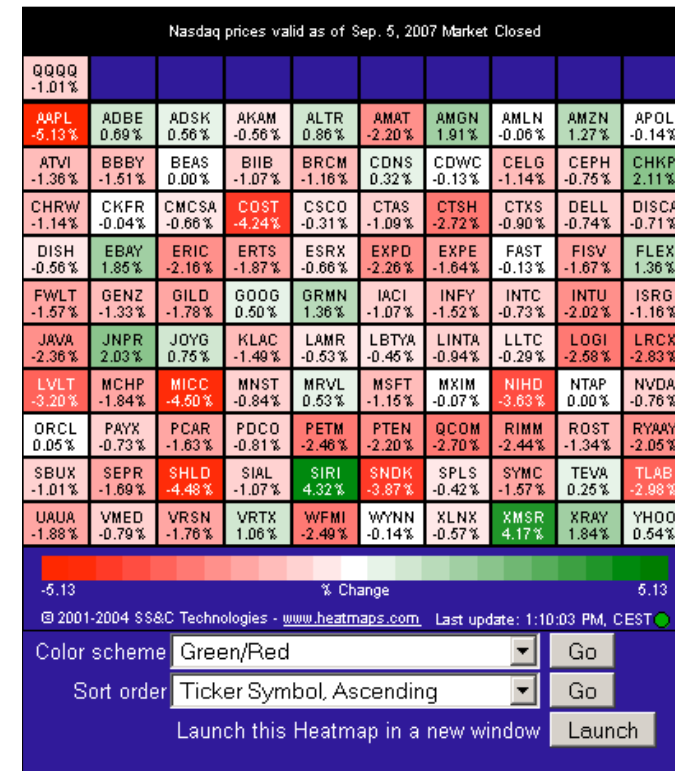

# Color Rules II

- ≡ For larger areas on a white background use low-saturation light colors
- ≡ Small color-coded objects should be given high saturation
- ≡ Use red and green in the center of the field of view (edges of retina not sensitive for these)
- ≡ Use black, white, yellow in periphery
- ≡ Use color for grouping and search
- ≡ Color Blindness Simulator: <http://www.ete.com/tools/colourblindsimulator/>
- ≡ Generation of color families
  - ≡ Use canonical colors
  - ≡ Family members should differ by saturation
  - ≡ Better: saturation and lightness

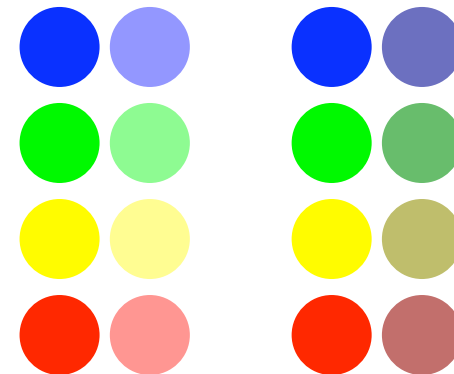

# Bivariate Color Coding

- ≡ Recap: color is three-dimensional
- ≡ Two data dimensions may be mapped to different color dimensions (e.g. hue and saturation, hue and lightness)
- ≡ Problem: bivariate color coding has been found notoriously difficult to read (Wainer & Francolini, 1980)
- ≡ The same applies to multidimensional color coding
  - ≡ E.g. amount of red, amount of green, amount of blue for coding colored dots in scatterplot (Ware & Beatty 1988)
  - ≡ Clusters could be easily identified by the participants of a user test
  - ≡ Precise decoding of the color components difficult



# Example: Bivariate Color Coding

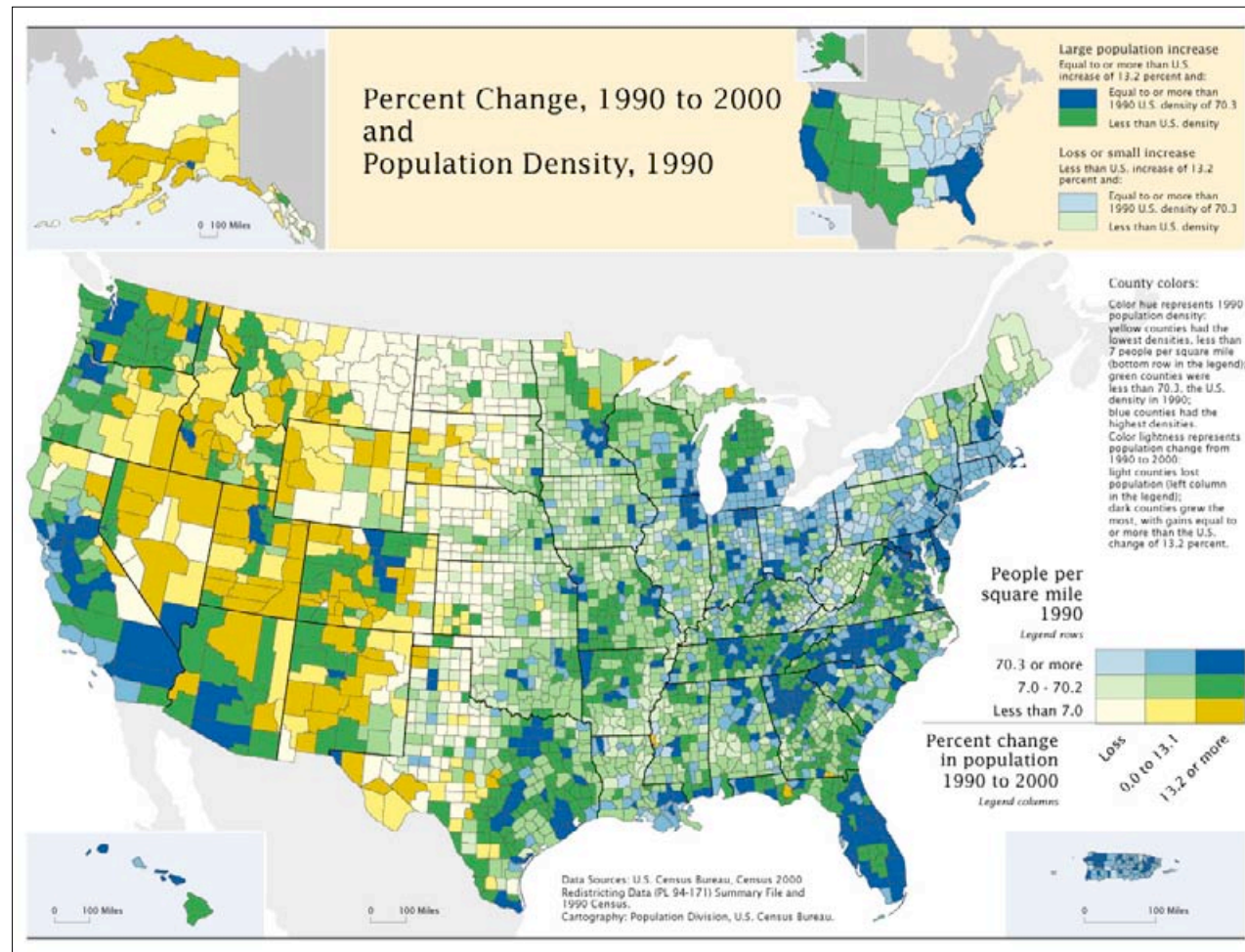

Image by Cynthia Brewer, <http://www.psu.edu/ur/2003/MapColorphotos.html>

# Outline

- ☰ Perception Definition & Context
- ☰ Preattentive processing
- ☰ Gestalt Laws
- ☰ Change Blindness
- ☰ Data encoding – glyphs
- ☰ Data encoding – color
- ☰ Characteristics of Visual Properties

# Characteristics of Visual Properties

- ≡ Some properties possess intrinsic meaning
  - ≡ Density with Grayscale: the darker the more
  - ≡ Size / Length / Area: the larger the more
  - ≡ Position: depending on culture, in Europe the leftmost / topmost are first
  - ≡ Color: depending on culture, e.g. white associated with death in Japan
- ≡ Accuracy of representations for quantitative measures (empirically verified by Cleveland & McGill, 1985)

(Few, 2004)

Attribute	Quantitative	Qualitative
Line length	x	
2D position	x	
Orientation		x
Line width		x
Size		x
Shape		x
Curvature		x
Enclosure		x
Hue		x
Intensity		x

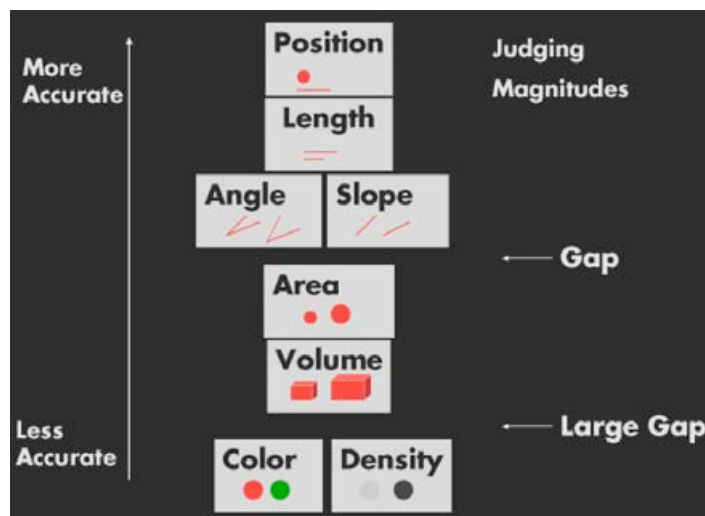

(Mackinlay, 1988)

# Characteristics of Visual Properties

- ≡ Jaques Bertin: Semiology of Graphics, 1983 (english translation)
- ≡ Guidance on retinal variables (encoding mechanisms) and measurement properties

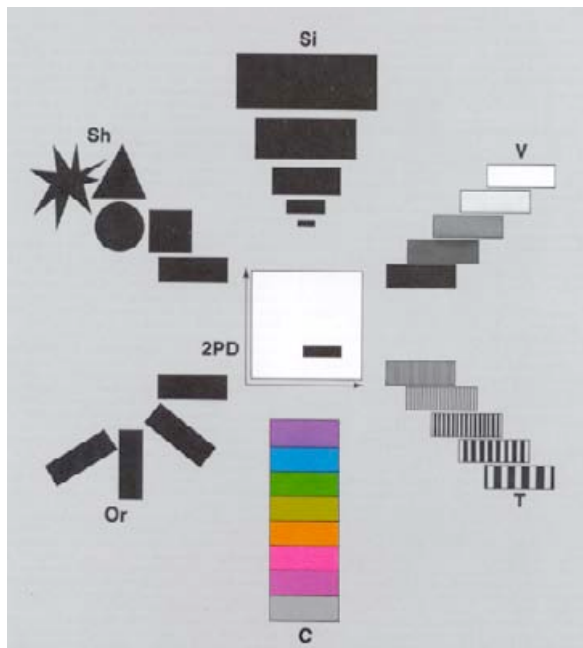

	Association The marks can be perceived as SIMILAR	Selection The marks are perceived as DIFFERENT, forming families	Order The marks are perceived as ORDERED	Quantity The marks are perceived as PROPORTIONAL to each other
Size				
Value				
Texture				
Colour				
Orientation				
Shape				

Reproduction of Bertin's diagram by Spence 2004

# Characteristics of Visual Properties

- ≡ Ranking of perceptual tasks by Mackinlay 1986 (estimation, not empirically verified)
- ≡ Tasks in gray boxes are not relevant to these types of data

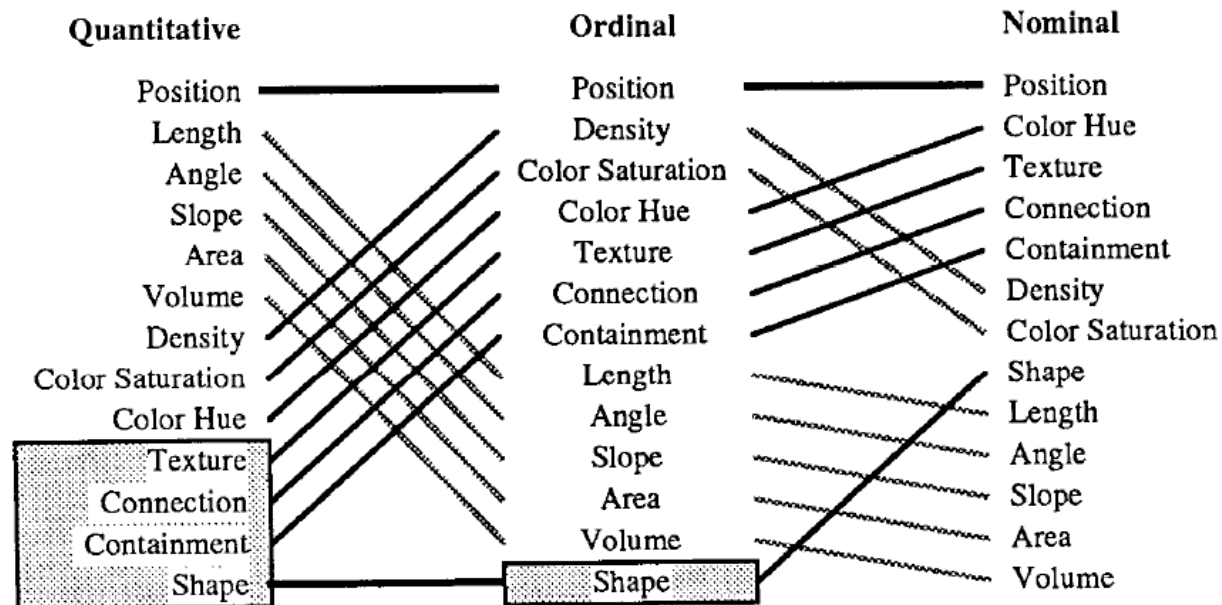

# Sources & Literature

- ≡ Obligatory paper to read and summarize:

**C. Healey: “Perception in Visualization” -**

<http://www.csc.ncsu.edu/faculty/healey/PP/index.html>

- ≡ C. Ware: “Information Visualization. Perception for Design”, 2. Auflage, 2004.
- ≡ J. Mackinlay: “Automating the design of graphical presentations of relational information”, ACM Transactions on Graphics, Volume 5, Issue 2, p. 110-141, 1986.
- ≡ Perception: An introduction to the Gestalt-theorie (Kurt Koffka, 1922):  
<http://psychclassics.yorku.ca/Koffka/Perception/perception.htm>
- ≡ Lecture material, John Stasko

