

10. Presentation Approaches I

Dealing with the presentation problem

Lecture „Informationsvisualisierung“

Prof. Dr. Andreas Butz, WS 2012/13

Concept and slides: Thorsten Buring,

3rd, revised edition

Outline

- Presentation problem
- Zoomable user interfaces (ZUIs)
 - Development history
 - Space-scale diagrams
 - 2.5D
 - Advanced ZUI designs
 - Orientation in ZUIs
- Overview+detail interfaces
 - Abstract overviews
 - Performance issues
 - View coordination
 - View Layout
 - Zoom factors

Presentation Problem

- Very often information spaces have to be displayed, which are significantly larger than the screen size
 - Too many data cases
 - Too many variables
- Potential techniques to maximize the number of information objects that can be displayed
 - Data encodings (see lectures 3 & 4)
 - Interaction and view transformations
 - Hybrid approaches

Presentation Problem

- Most common workaround: scrolling interfaces
- Advantages
 - Many users are familiar with scrollbars
 - Navigation at different speed
 - Thumbs show position and ratio of information space and view size
 - Have been found effective to move small distances
- Disadvantages
 - Only horizontal and vertical shifts
 - Scrollbars usually do not preview the content of the off-screen space
 - Take away screen space
 - Limited to linear navigation
 - Does not scale (search times and interaction sensitivity increase)



Presentation Problem

- Interaction and view transformations
 - Zoomable user interfaces
 - Overview+detail interfaces
 - Focus+context interfaces (upcoming lecture)

Zoomable User Interfaces

- ZUIs aka multiscale interface
- “Navigation in information spaces is best supported by tapping into our natural spatial and geographic ways of thinking” (Perlin & Fox 1993)
- “By moving through space and changing scale the users can get an integrated notion of a very large structure and its contents, and navigate through it in ways effective for their tasks” (Furnas & Bederson 1995)
- Data objects must be organized in space and scale
- Users can manipulate which part of the information space is shown, and at what scale
 - Panning: movement of the viewport over the information space at a constant scale
 - Zooming: altering the scale of the viewport such that it shows a decreasing fraction of the information space with an increasing magnification and vice versa (Spence 2007)
- Due to non-linear navigation ZUIs develop their full potential as the size of the information space grows

Zoomable presentation tool: Prezi.com

- demo: <http://prezi.com/b9fk1xyfbber/>



Filip Radulovic
Nikola Milikic

Smiley wiki:

www.smileyontology.com

Development History

- 1978 - Spatial Data Management System (SDMS) (Donelson 1978)
- Visionary system for visualizing (and zooming) visual database representations
- Relied heavily on custom hardware
 - Rear-projected color television display
 - Octophonic sound system
 - Chair with isometric joysticks, touch-sensitive Tablets and a digital lapboard

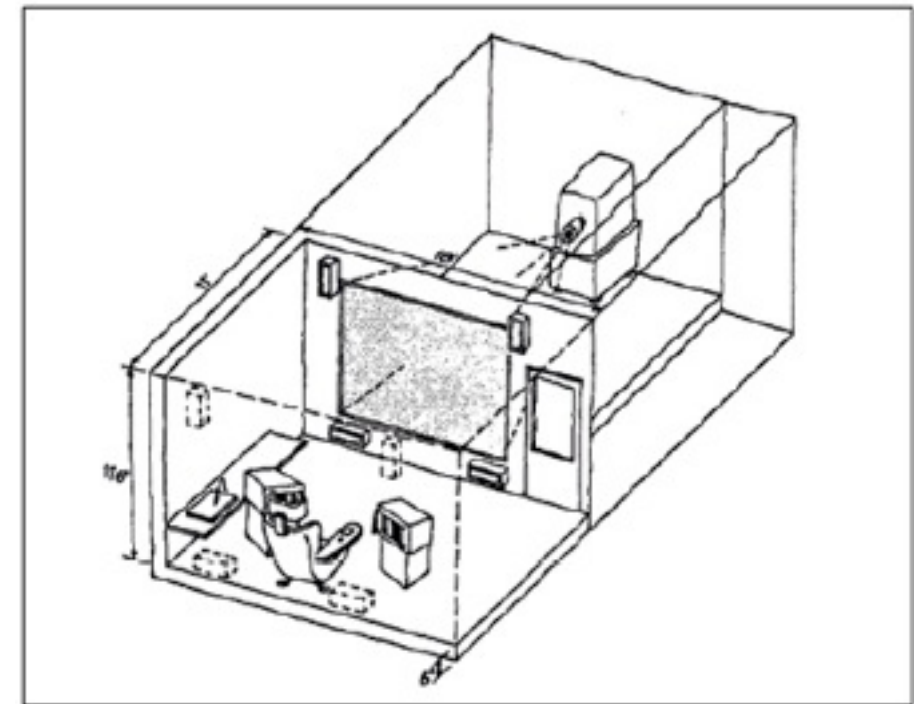

Development History

- 1993 - Pad, the first multiscale interface (Perlin & Fox 1993)

The screenshot displays a 'Quarterly Report' window with a main 'Income Statement' table. Two magnified portals are overlaid on the main view. The first portal, titled 'ADVERTISING', shows a detailed breakdown of advertising expenses. The second portal, titled 'Revenues', shows a breakdown of revenue components. Arrows indicate the zooming relationship between the main view and the portals.

Item	Value	Value
Revenues	277,401,000	294,715,000
Operating Costs:		
Cost of Sales	207,000,000	217,540,000
Sell. Admin.	50,000,000	49,995,000
EBIT etc.	20,401,000	27,180,000
Int. & debt exp.	20,000,000	11,000,000
Net Income	0,401,000	16,180,000

Item	Value
Advertising	14,700,000
Agency fees	10,000,000
Production	4,700,000
Other	0,000,000

Item	Value
Product sales	200,000,000
Service fees	50,000,000
Other	27,401,000

- Alternative to the Windows Paradigm
- Visualizes an infinite two dimensional information plane populated with information objects the users can interact with (e.g. text files, personal calendar...)
- Important concepts
 - Portals as customizable views to facilitate navigation
 - Semantic zooming (will be discussed later on)
 - Designed to run on standard hardware
- Screenshot shows quarterly report displayed using Pad along with portals to provide magnified views of details

Development History

- 1994 - Pad++ (Bederson & Hollan 1995), successor of Pad
- Mostly technical enhancements
- Smooth zooming with hundreds of thousands information objects
- Implemented in C++
- Supposed to support platforms ranging from workstations to PDAs and set-top boxes (scalability of ZUIs!)
- Improved platform independency was only achieved by later ZUI toolkits
 - Jazz (2000), Java
 - Piccolo (2004), Java, .NET C#, compact framework
- <http://www.cs.umd.edu/hcil/jazz/>

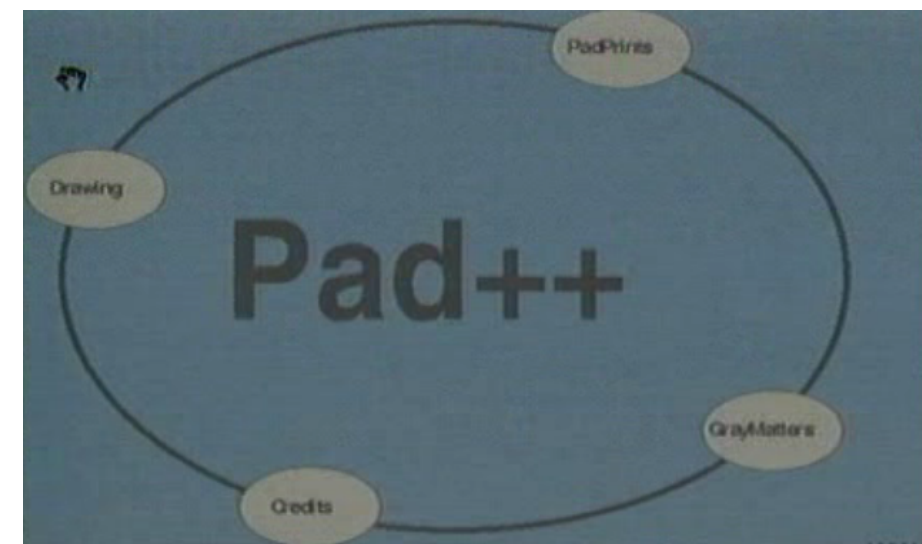

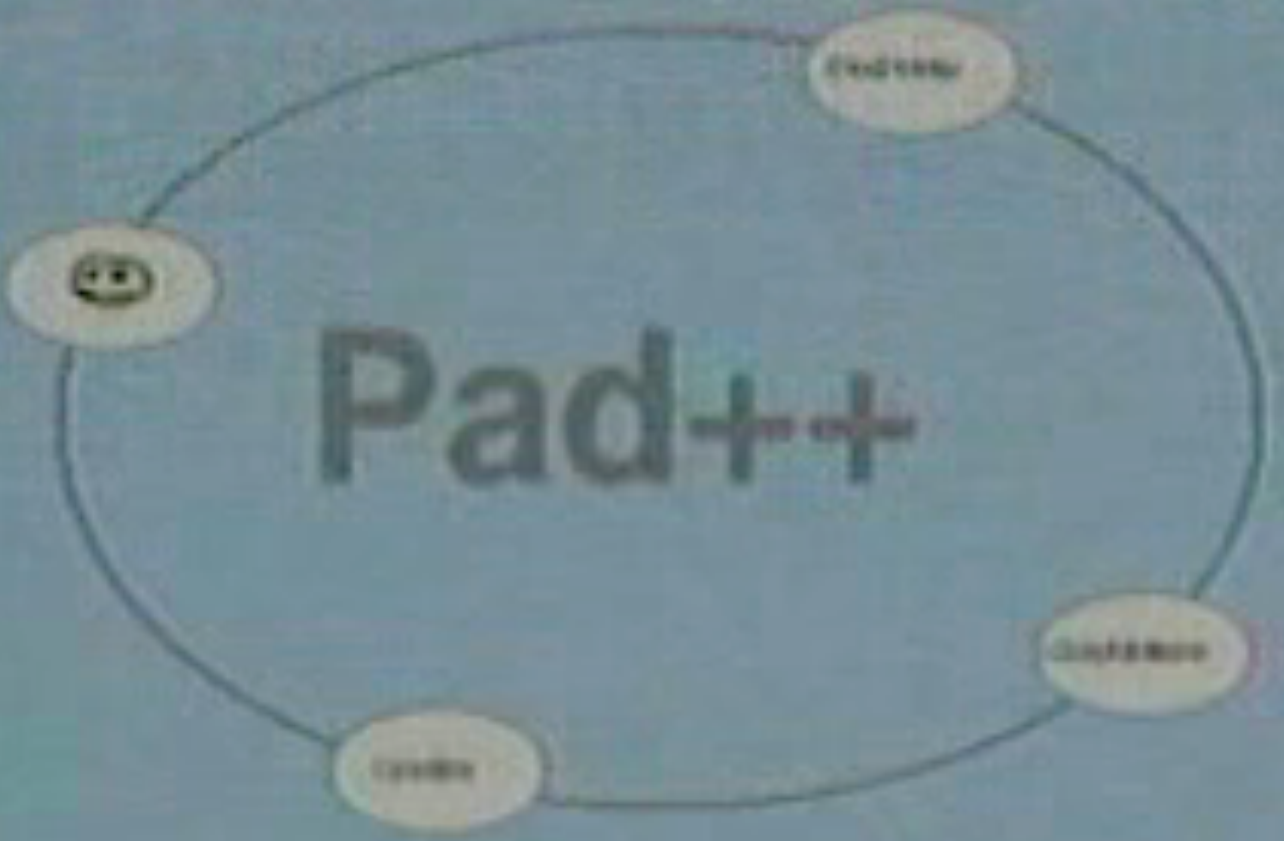
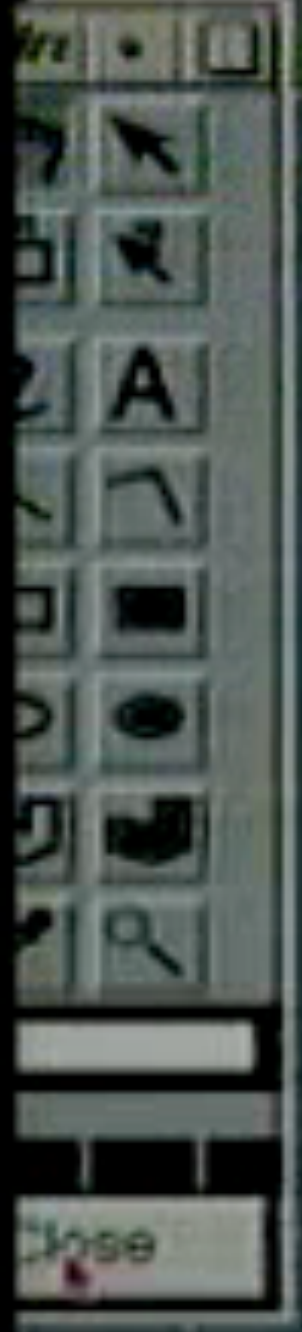

Space-Scale Diagrams

- Furnas & Bederson 1995
- Diagrams to understand and model multiscale interfaces
- Basic idea
 - 2D image represents information space
 - Construct diagram by creating copies of the 2D image at each possible scale and stacking them up to form an inverted pyramid
- Two axes u_1 and u_2 represent spatial dimensions of the image
- Vertical v axis represents scale (magnification from 0 to infinity)

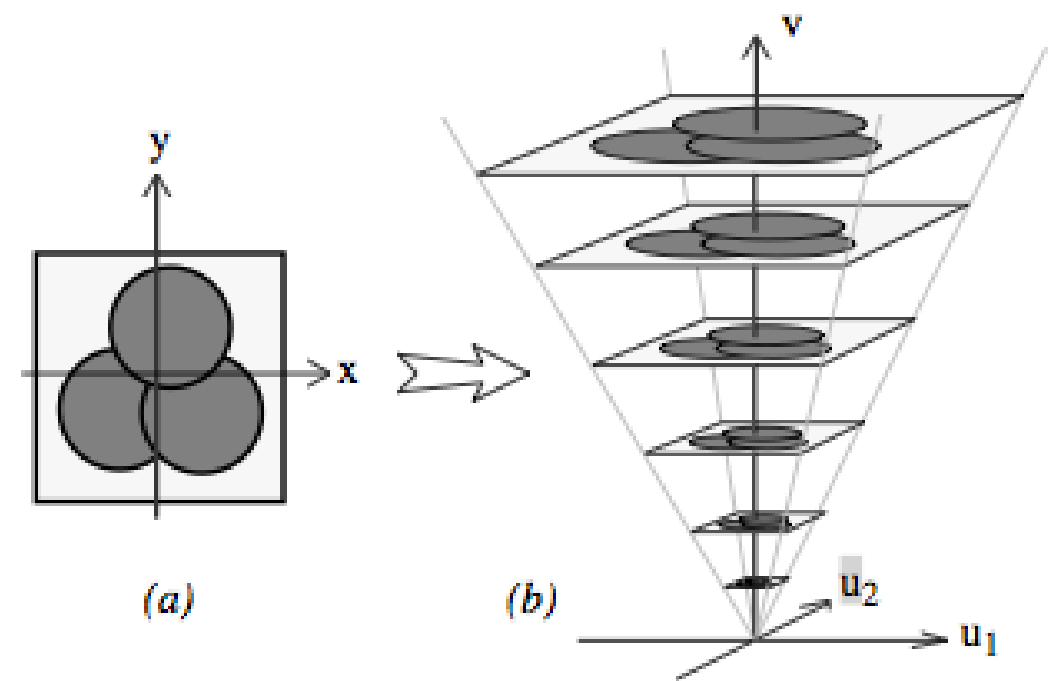

Figure 1. The basic construction of a Space-Scale diagram from a 2D picture.

Space-Scale Diagrams

- Property II

- A point in the original 2D picture becomes a ray in this space-scale diagram
- Hence regions of the 2D picture become generalized cones in the diagram

- Property III

- The only meaningful contents of the space-scale diagram are properties invariant under a shear
- Do not try to read too much out of the diagram!

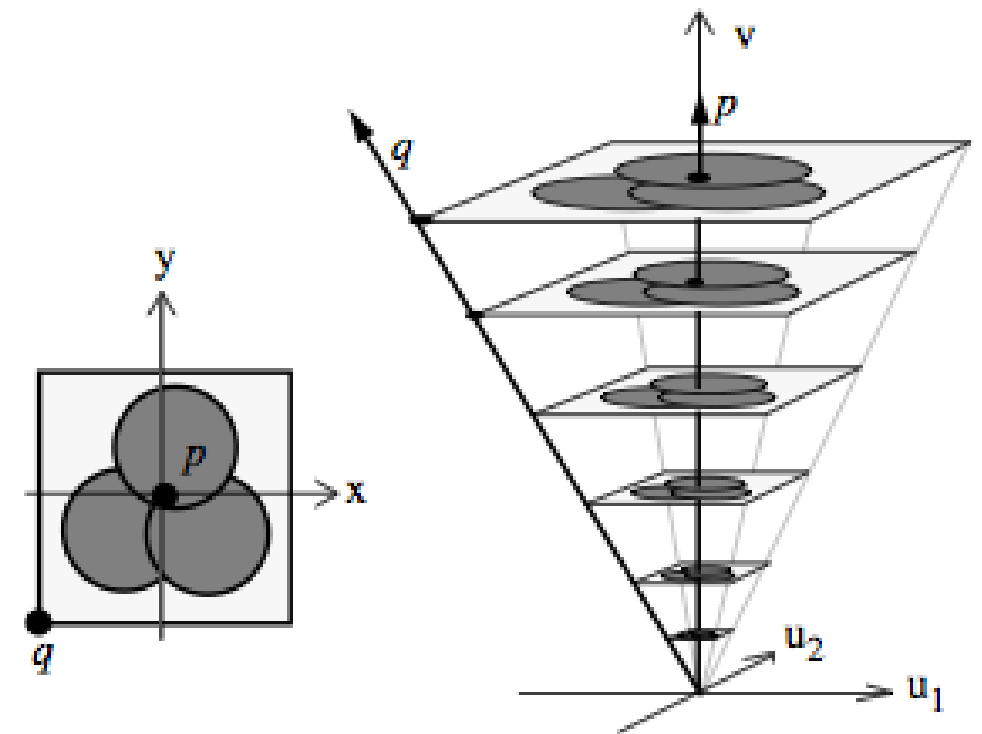
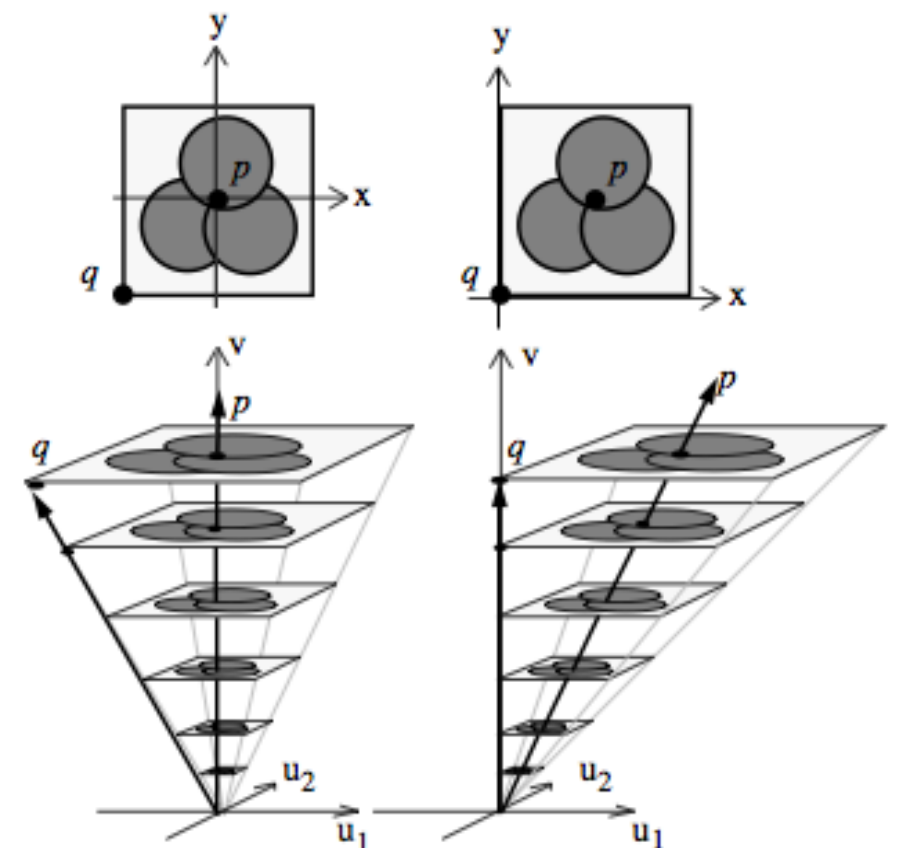
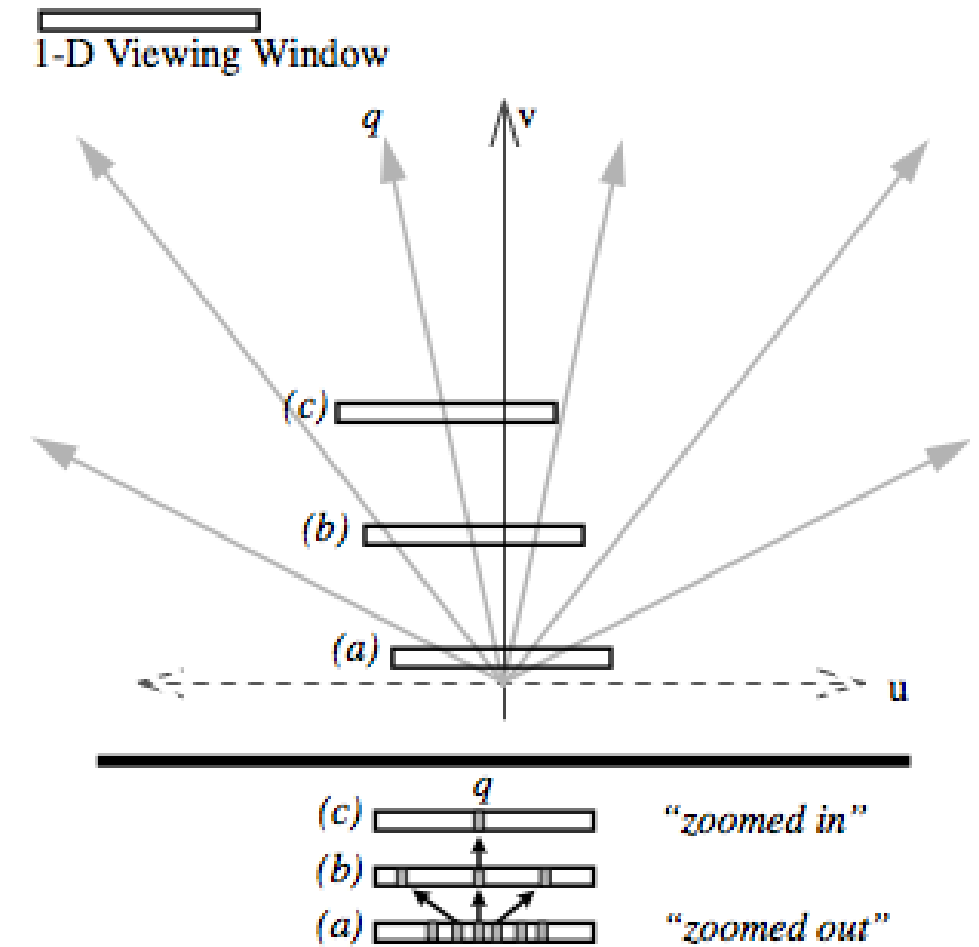

Figure 3. Points like p and q in the original 2D surface become corresponding “great rays” p and q in the space-scale diagram. (The circles in the picture therefore become cones in the diagram, etc.)



Space-Scale Diagrams

- Simplification of the diagram
 - Compress the two spatial dimensions to 1D
 - 3D to 2D diagram
 - Viewing window becomes a 1D slit
 - 6 rays represent six points in the 1D space
 - Example starts with a view of all 6 points and then zooms in on point q



Space-Scale Diagrams

- Study basic pan-zoom trajectories
- (a) panning: position changes, scale remains constant
- (b) pure zoom: central position remains constant, scale changes
- (c) zoom-around: zoom is centered around some fixed point other than the center of the window (in the example point q)

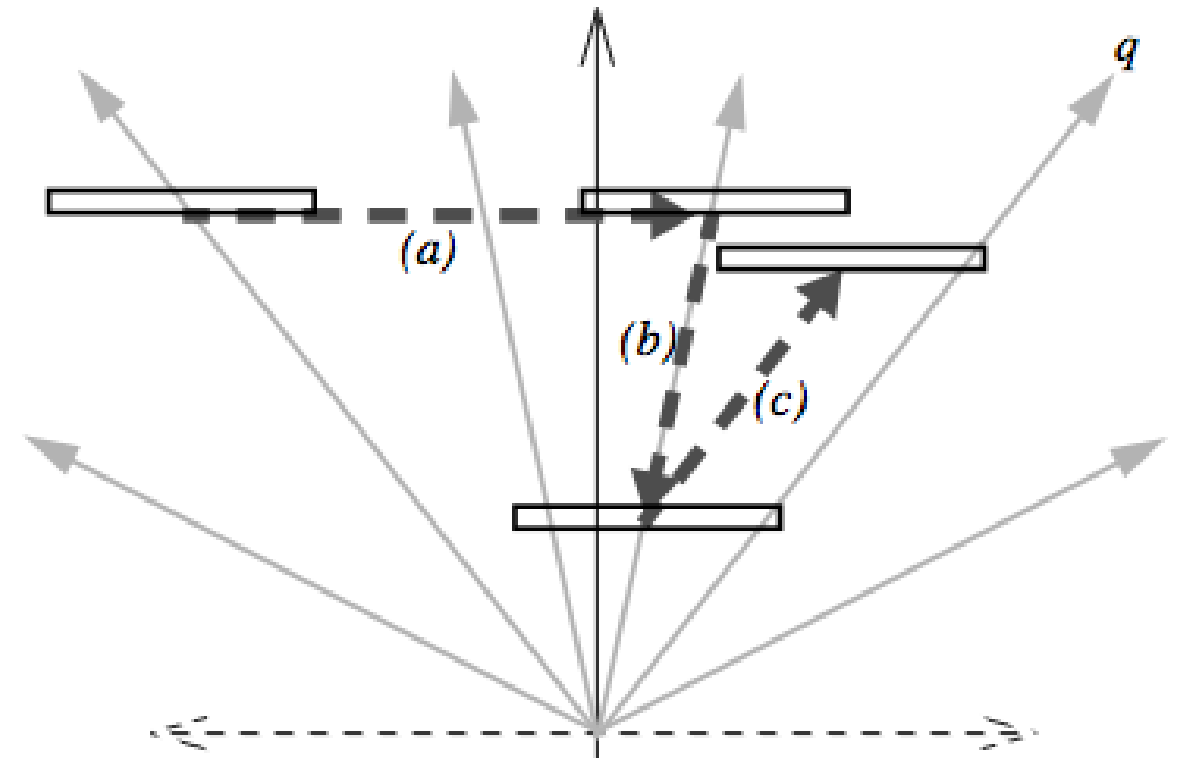

Figure 6. Basic Pan-Zoom trajectories are shown in the heavy dashed lines: (a) Is a pure Pan, (b) is a pure Zoom (out), (c) is a "Zoom-around" the point q .

Space-Scale Diagrams

- Joint pan-zoom trajectory
- Use case: automatic navigation to a pre-defined point
- Naive approach: calculate pan and scale distance separately and execute them in parallel - does not work!
- Reason
 - Pan is linear
 - Zoom is logarithmic
- Space-scale diagram shows how the trajectory s needs to be modeled
- View monotonically approaches a point in both pan and zoom
- Scale factor z must change hyperbolically with the panning of x

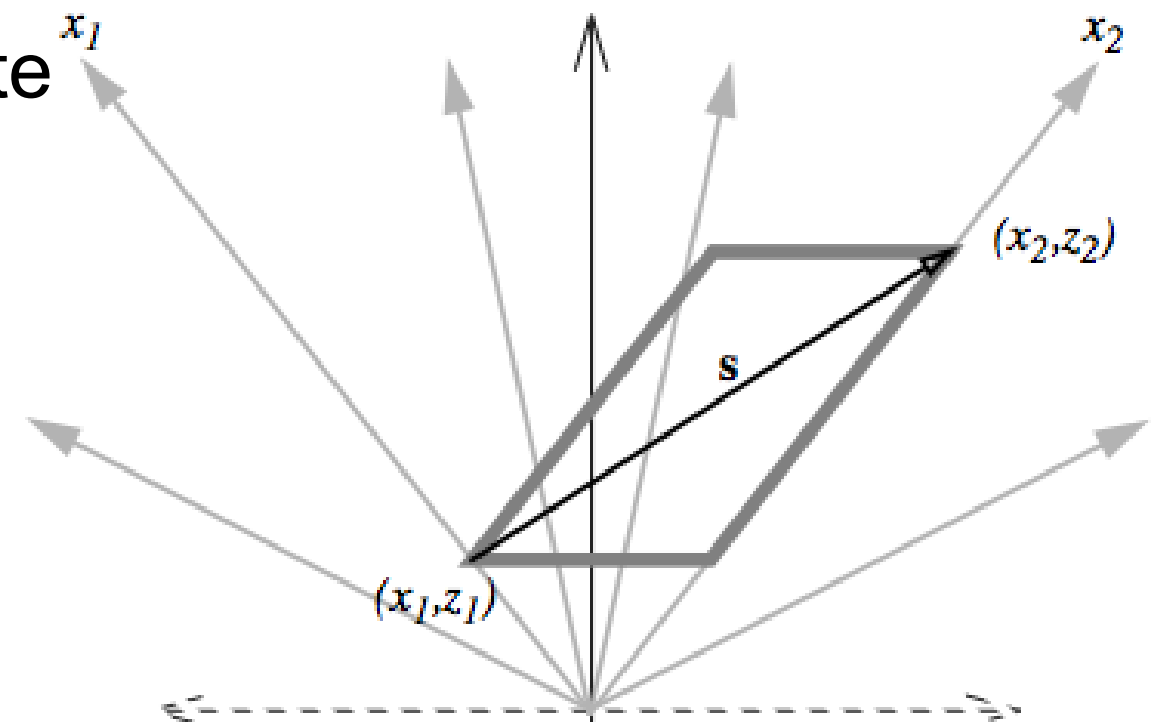

Figure 7. Solution to the simple joint pan-zoom problem. The trajectory s monotonically approaches point 2 in both pan and zoom.

Space-Scale Diagrams

- Shortest path between two points
- Not a straight line, i.e. no pure panning!
- Remember: zoom is logarithmic, i.e. provides exponential accelerator for navigating very large spaces
- Arrows of the trajectories represent units of cost
- Diagram shows: to travel a vast distance the following strategy is fastest
 - Zoom out to a scale at which the old and the target position are close together
 - Short pan
 - Zoom back in

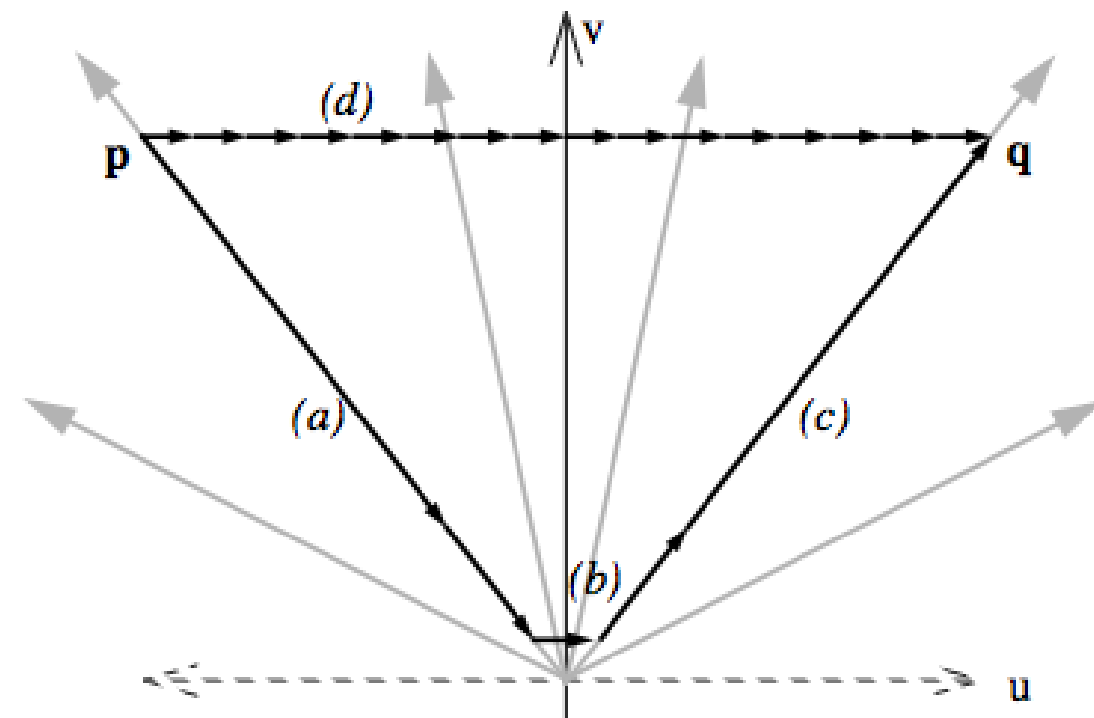

Figure 8. *The shortest path between two points is often not a straight line. Here each arrow represents one unit of cost. Because zoom is logarithmic, it is often “shorter” to zoom out (a), make a small pan (b), and zoom back in (c), than to make a large pan directly (d).*

Zoom Accelerator

- Power of ten
- 10 million light years from the Earth travel in 40 zoom steps to the protons of an oak leaf in in Tallahassee, Florida
- <http://micro.magnet.fsu.edu/primer/java/scienceopticsu/powersof10/index.html>

10 million light years away from the Milky Way.



10^{+23} meters

10 million light years



More Recent Example: Photosynth

- <http://photosynth.net>

"What if your photo collection was an entry point into the world, like a wormhole that you could jump through and explore..."



Try the Tech Preview

More Recent Example: Photosynth



2D, 2.5D and 3D

- ZUIs are NOT 3D but 2.5D applications
- Why not make them 3D?
 - Historical reason: developers of seminal ZUIs wanted to avoid special hardware requirements (by now 3D chips are standard)
 - Simplicity - 3D systems are usually hard to navigate using current 2D display and input device technology
- Still, it is hypothesized that high-quality 3D interfaces may better exploit the human capabilities of spatial cognition and thus can improve user performance
- Mixed empirical results in previous research

2D, 2.5D and 3D

- Example evaluation: physical and virtual systems to retrieve documents in a 2D, a 2.5D, and a 3D setting (Cockburn & McKenzie 2002)
- Results indicate performance advantage for 2D layout to locate images of web pages
- Participants also found the higher dimensional interfaces more cluttered and less efficient

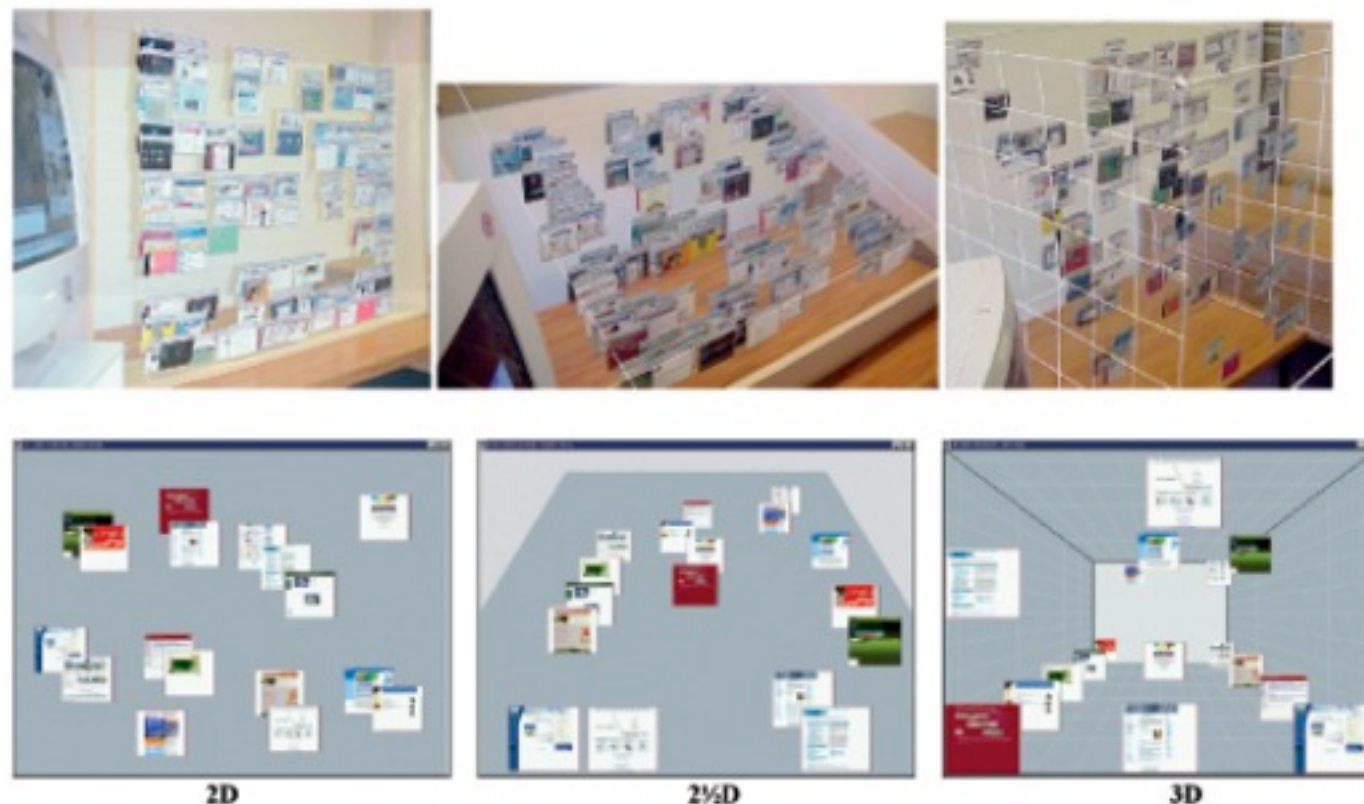

Smooth Zooming

- Older systems only provide a two-level zoom or navigation via coarse jumps
- Smooth continuous zooming
 - More demanding to implement
 - Helps the users to preserve their orientation during navigation
 - Users build a mental map of the information space
 - May improve user satisfaction via hedonic qualities - flying through space metaphor

Semantic Zoom

- Most common is geometric zoom: simply magnifies objects
- Semantic zoom: objects change their appearance as the amount of screen real estate available to them changes
- Semantic zoom provided by a directory browser implemented with Pad++ (www.cs.umd.edu/hcil/pad++)

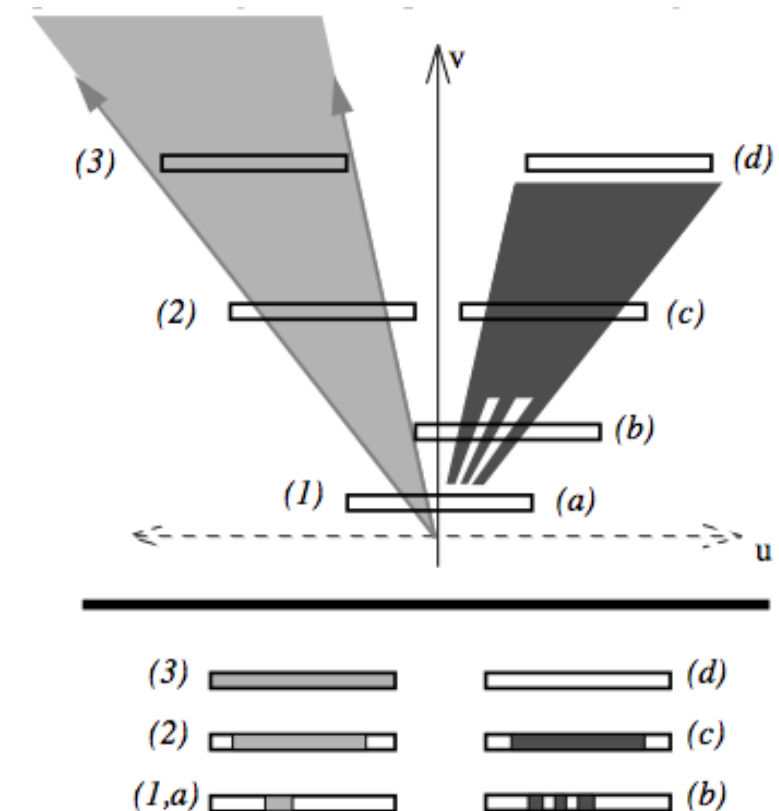
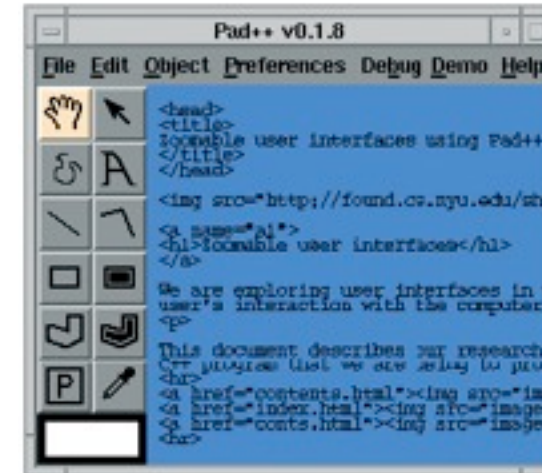
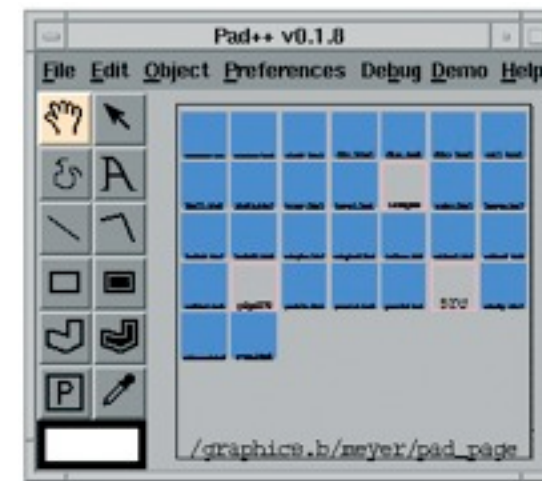

Figure 11. Semantic Zooming. Bottom slices show views at different points.

Goal-Directed Zoom (GDZ)

- Semantic zooming: users zoom in until the target objects shows the desired representation
- Goal-directed zoom: users choose a representation of an object and the change in scale and translation is automatically performed by the system (Woodruff et al. 1998b)



Orientation in ZUIs

- A common problem of ZUIs: the lack of context
- Continuous clipping of orientation cues during zooming
- Amount of context needed is hard to predict
- Depends on variables such as
 - Type and ordering of the information space
 - The users' familiarity with the information space
 - The task the users want to accomplish
- Example city map navigation: context needed by local citizen versus a first-time visitor
- Most straightforward way to rediscover context in ZUIs: zooming out
 - May also refresh the users' mental model of the information space
 - But: frequent zoom-outs can be tedious
 - Provide fast and precise interaction design to minimize the required effort

Desert Fog

- Jul & Furnas 1998
- More severe orientation problem for large or infinite multiscale spaces
 - Users zoom into white space between information objects until the viewport goes completely blank
 - Blank screen could mean:
 - There are no more object to be found in that direction -> zoom out
 - There are objects to come, but they are too far away to be seen -> zoom in
 - What to do?

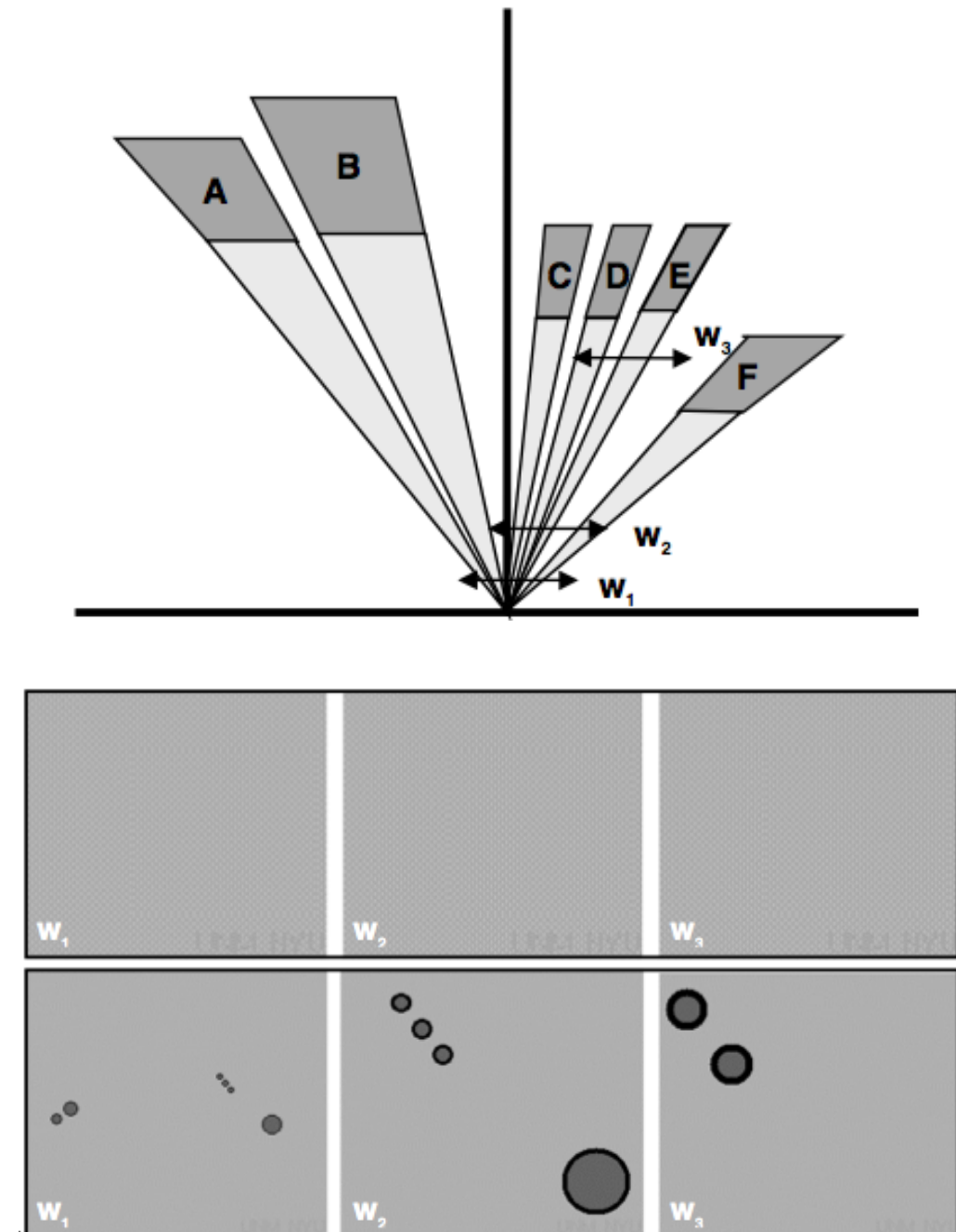

Desert Fog

- Add multiscale residues
 - Landmarks for each information object are drawn across scale (think of it as a beacon)
 - Blank screen always means that there are no more objects in that direction
 - Problem: clutter of multiscale residues
- Apply hierarchical clustering to reduce clutter
- Based on spatial proximity
- Problems
 - Where should a landmark be located?
 - Geometric center of a cluster? Meaningful?
 - Most representative object? How to identify?
 - How many levels of the hierarchy should be displayed when? Again, can cause clutter...

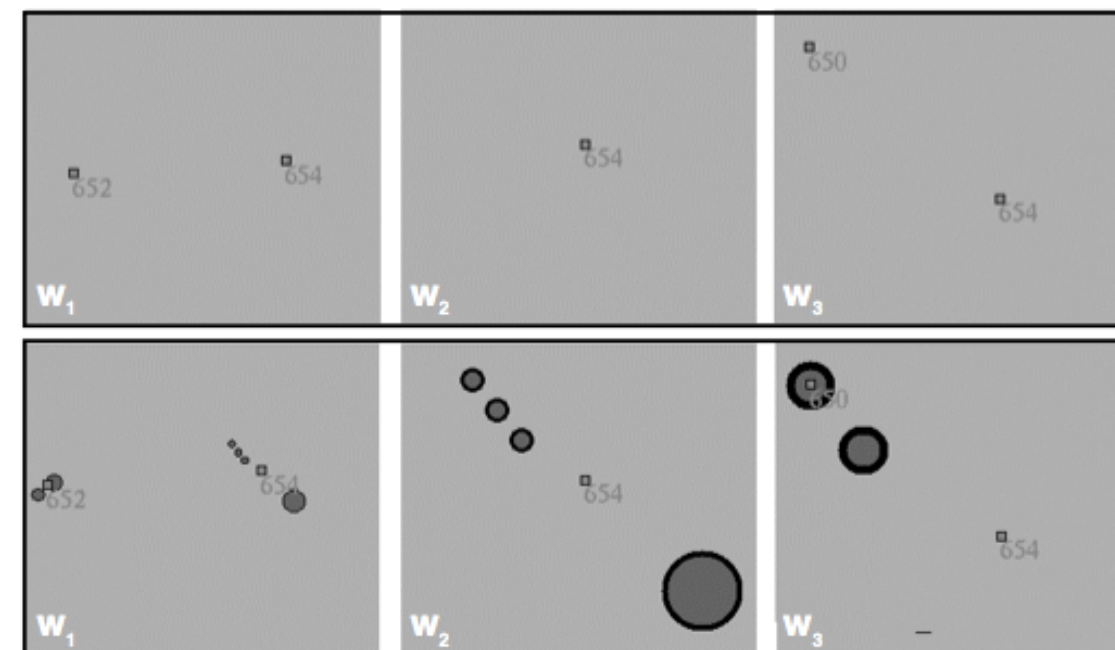
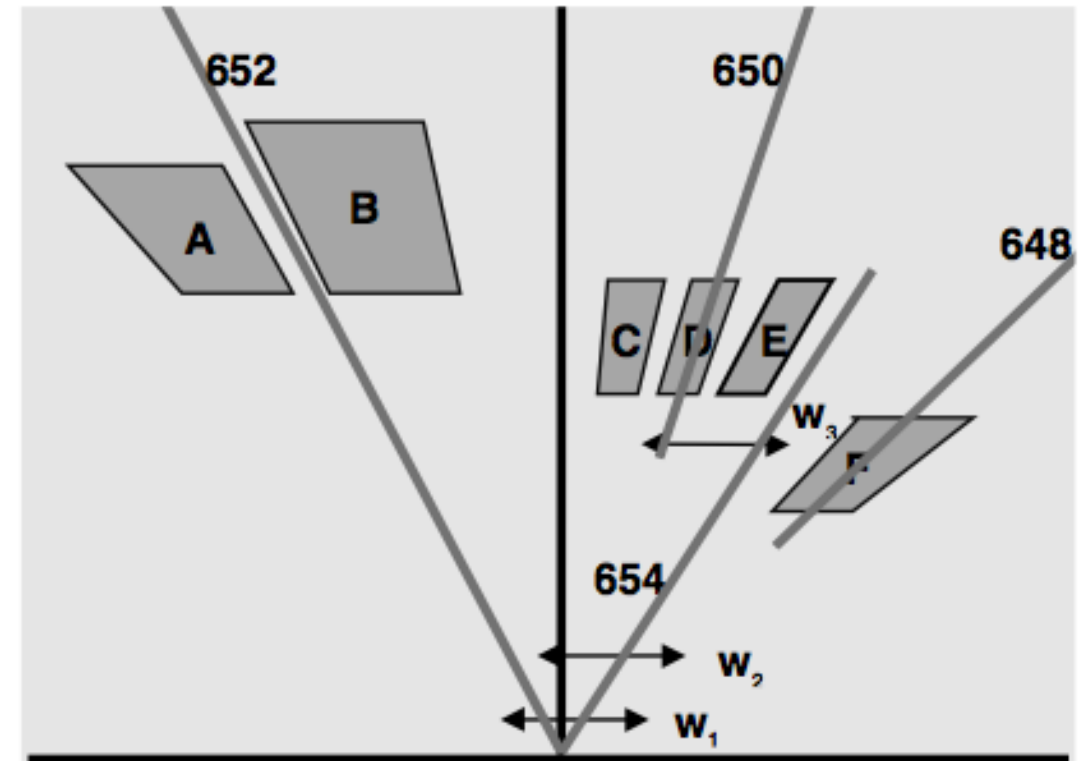

Desert Fog

- Concept of critical zones: provide residues of views not objects
- Single critical zone
 - Only views are highlighted, which contain objects
 - Bounding rectangle encloses all contained views
 - Dark rectangle means that the critical zone contains all objects in the world - no sense to zoom out further
- Problem: where to zoom in on inside a critical zone?
- Trial and error strategy

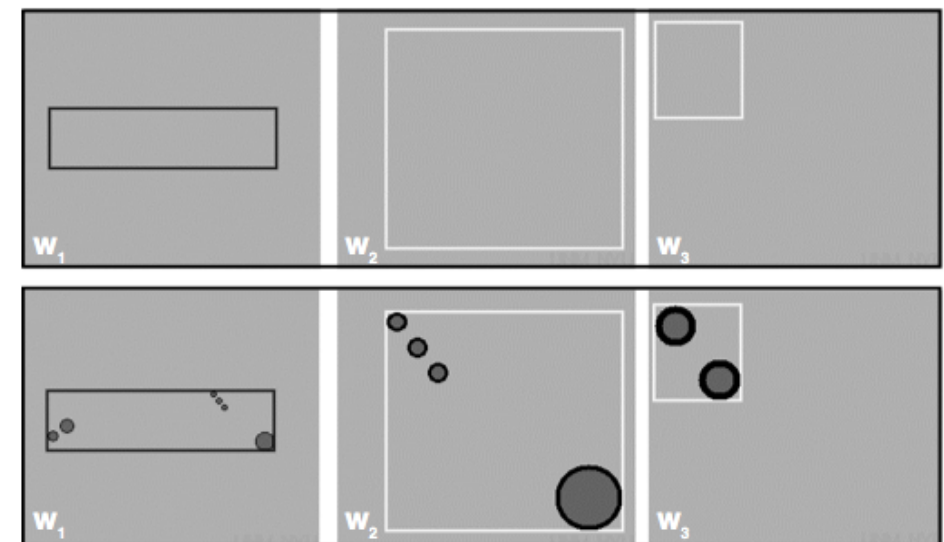
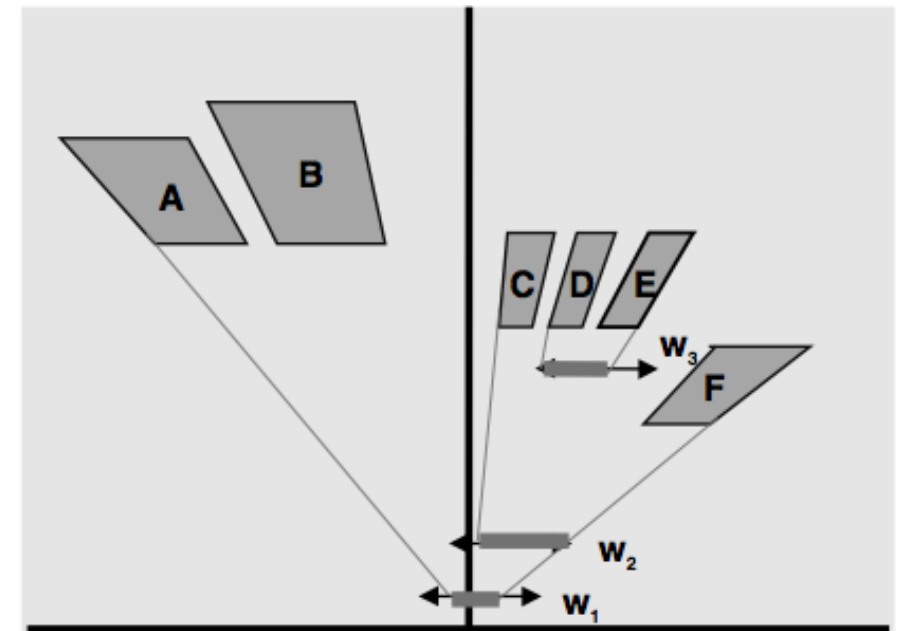

Desert Fog

- Improve navigation aid by showing multiple smaller critical zones
- At the same time limit the number of zones to not cause clutter
- M defines a size, above which a zone is split into smaller zones

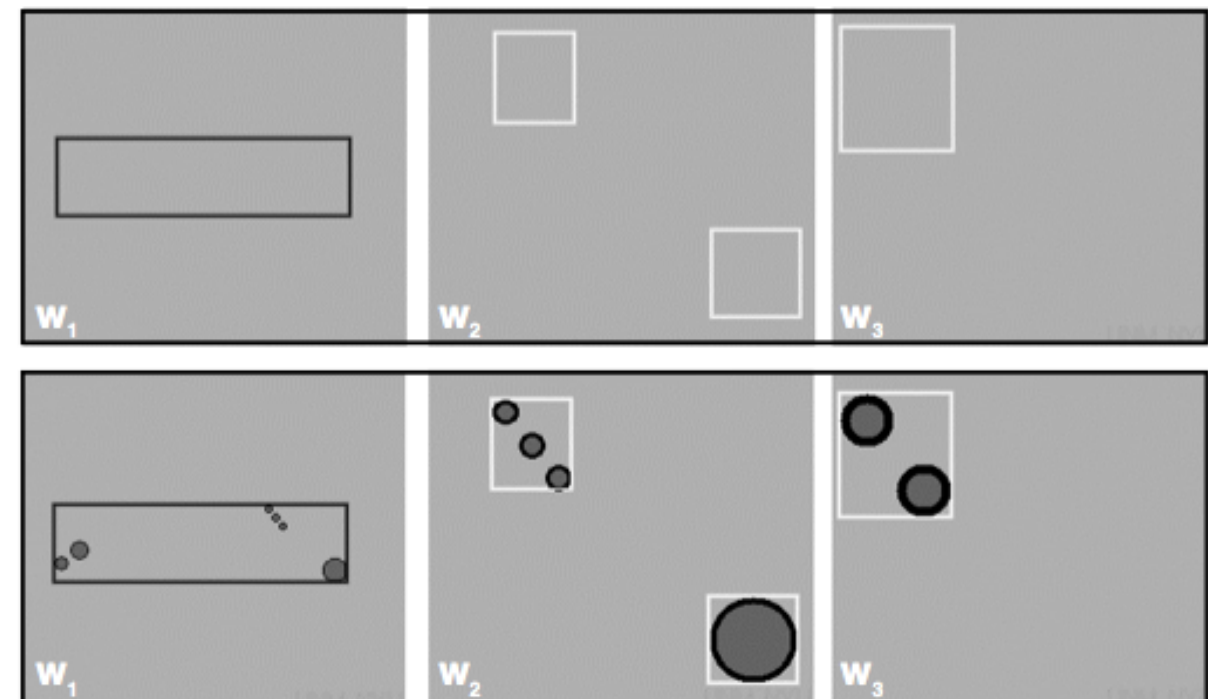
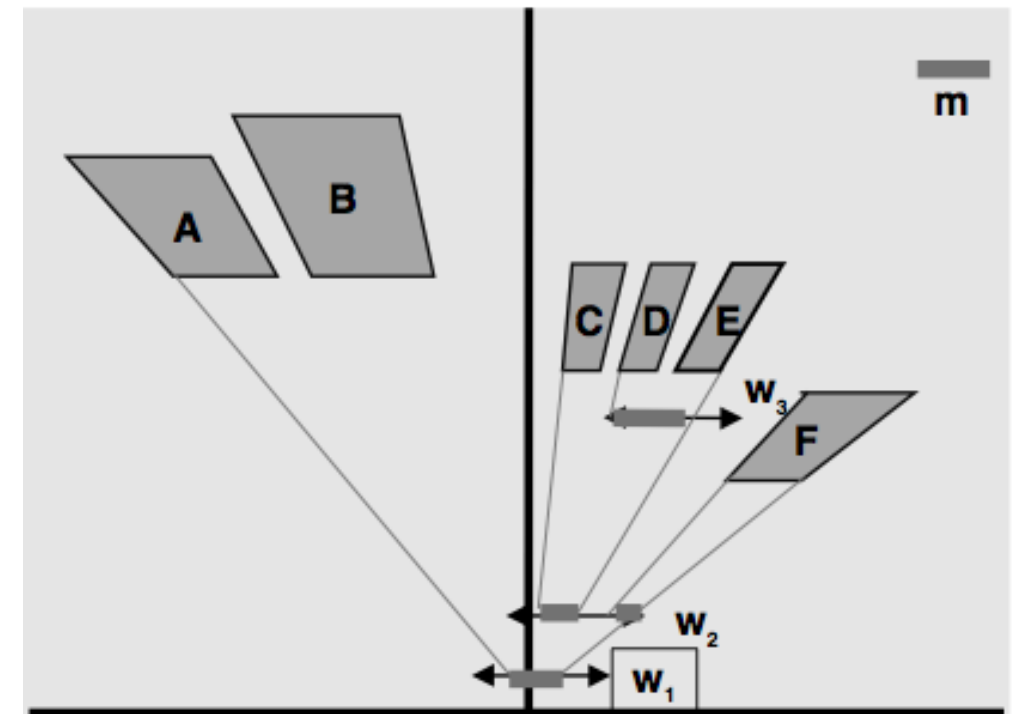

Overview+Detail

- Overview+detail (O+d) interfaces are characterized by multi-window layout
 - Detail view presents details
 - Overview window provides overview information of the information space
 - Overview windows are usually also enhanced with visual cues
- O+d interface with field-of-view box give users direct and constant feedback on their position in the information space
- Thus context information is preserved

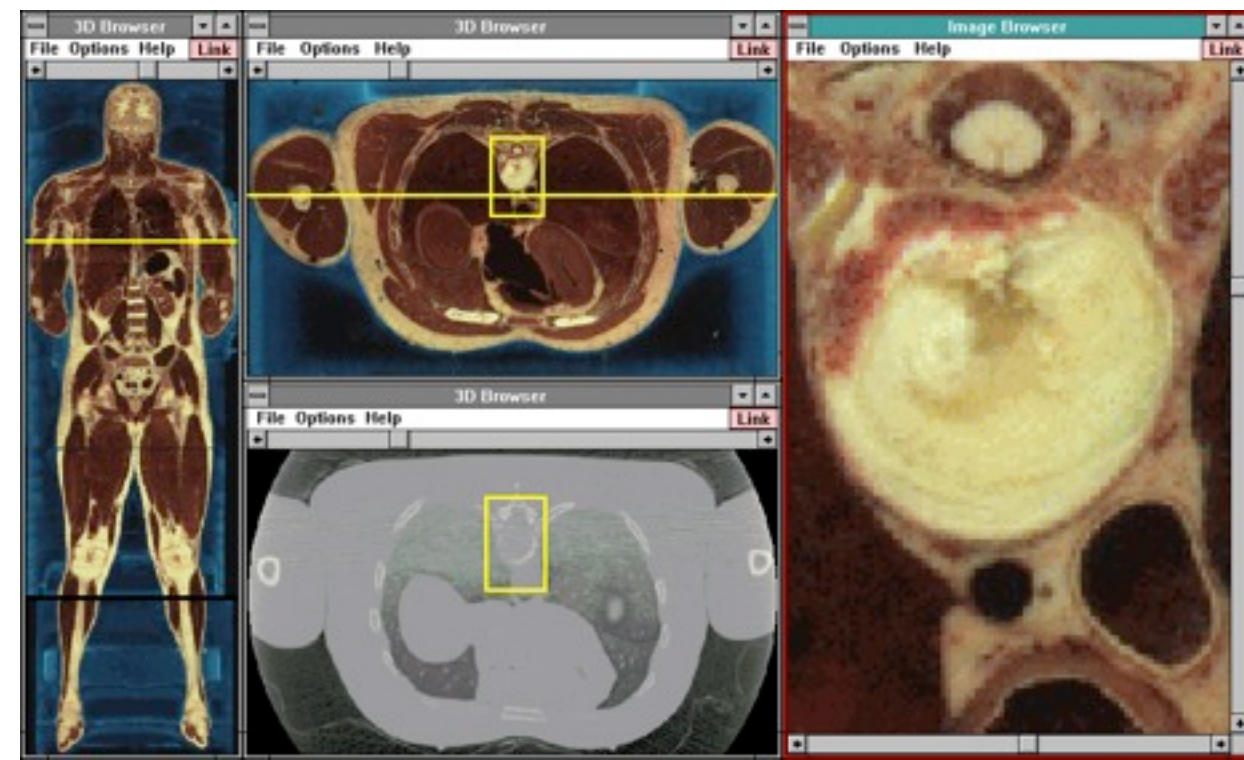

North & Shneiderman 1997

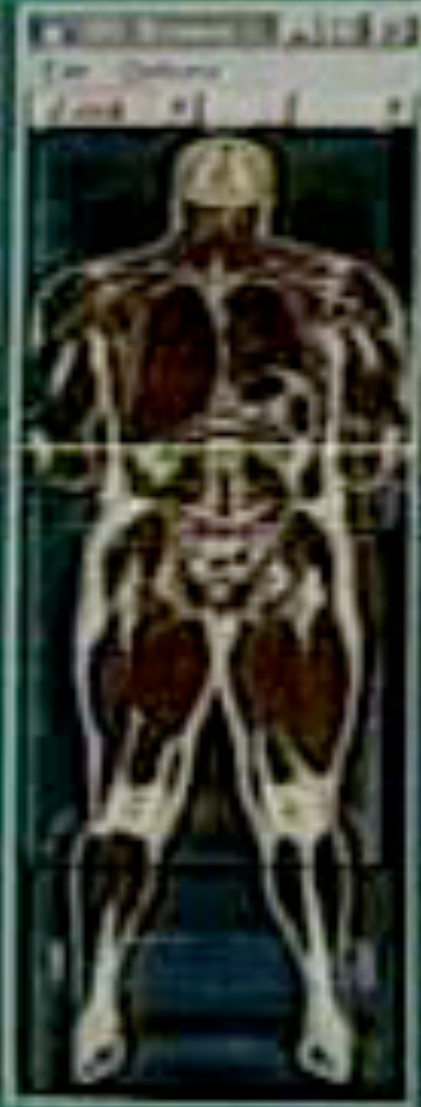
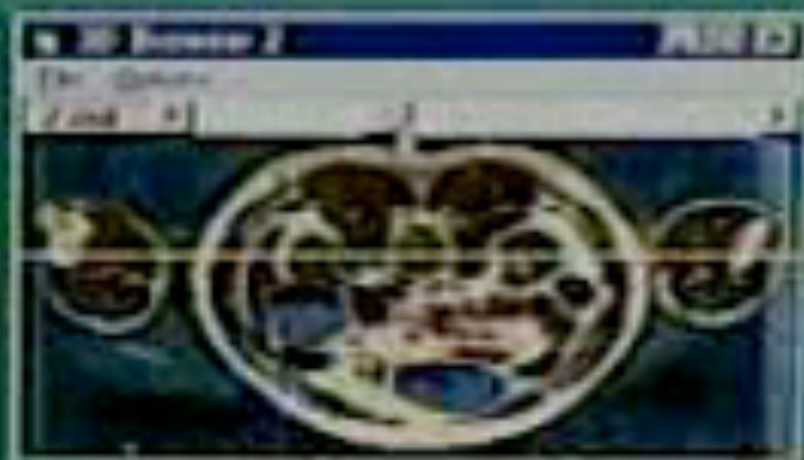

O+D in MS Word

The screenshot displays the Microsoft Word 2010 interface. The title bar shows the document name "DIS V4,4_Andreas.docx" and the zoom level "124%". The ribbon includes tabs for Home, Layout, Document Elements, Tables, Charts, SmartArt, and Review. The Review tab is active, showing options for Comments, Tracking (set to "Final"), Changes (Accept, Reject, Previous, Next), and Protection. The document content is split into two columns. The left column contains a table of contents with sections like "ABSTRACT", "Analysis", "Design", and "REFERENCES". The right column contains the main text, which includes a quote: "The cars did not separate us." (P21), followed by a paragraph about travelling together. Below this is another quote: "I went on a weekend trip together with a couple of friends. We used two cars for the trip. On the highway, we quickly lost sight of our friends in the other car. A couple of hours later, a short time before we had to leave the highway, I suddenly saw the other car again. I was surprised, because I didn't expect the others to be that close to us. Happily, I took my cell phone and called a friend in the other car. They were also happy to be close to us again." (P19). The text continues with a paragraph about the story further details and another quote: "After a weekend of wedding celebration, the guests all said goodbye to each other and went on their way in their cars - each one heading for very different cities in Germany. None". The status bar at the bottom shows "Print Layout View", "Sec 2", "Pages: 4 of 9", "Words: 2794 of 6594", and "124%".

O + D in Google Maps

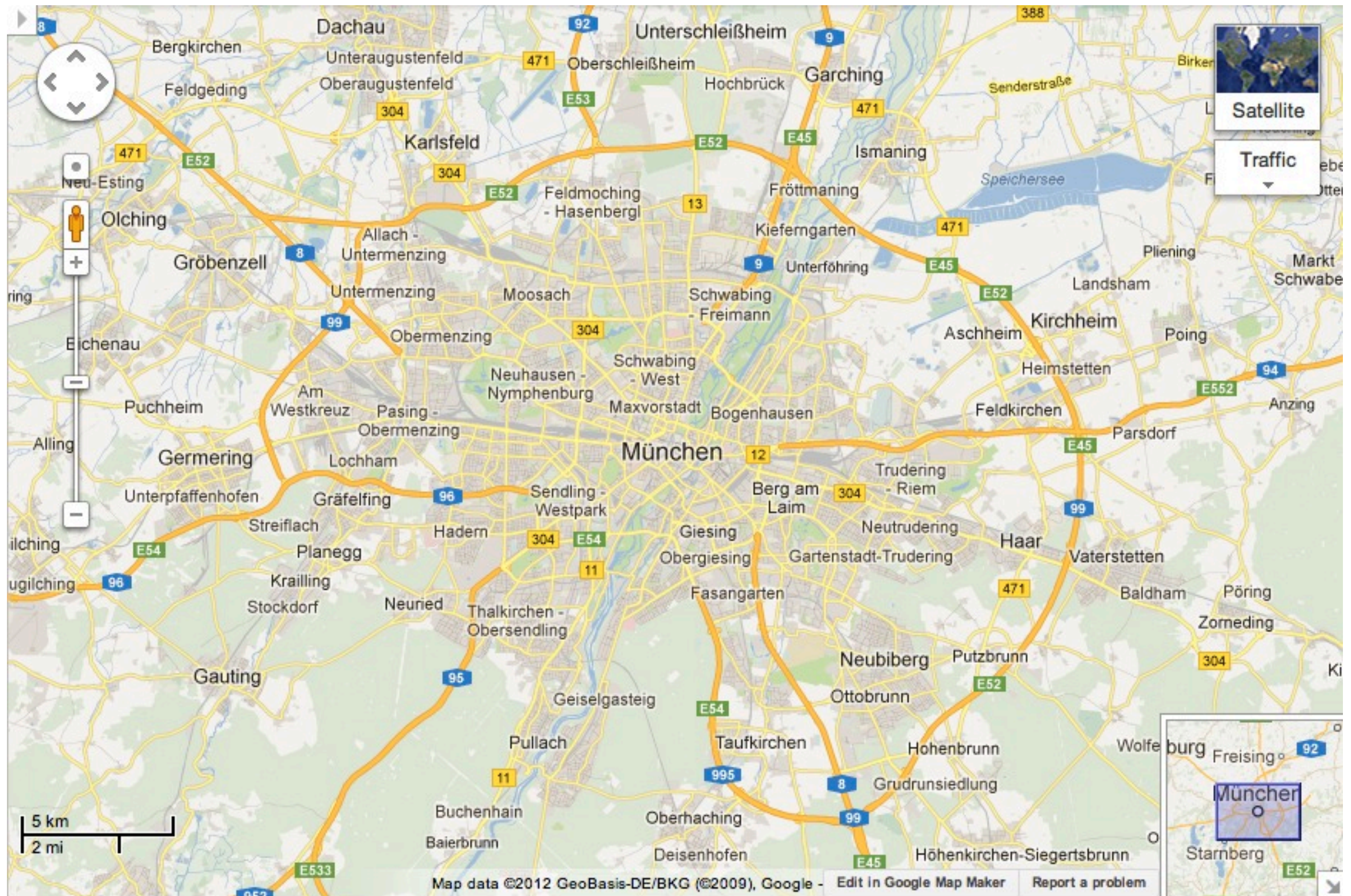

Abstract Overviews

- When showing a miniature of a reasonably large information space much detail information may be lost
- Could in some cases be solved by presenting intermediate views, but: display space limitations
- Abstract overviews use encodings to use limited screen space more effectively
- May also contain extra information not present in the detail view
- Example: document overview (Jerding & Stasko 1995)
 - Overview always shows the entire document
 - Intensity scale indicates text density
 - Color denotes sections

Abstract Overviews

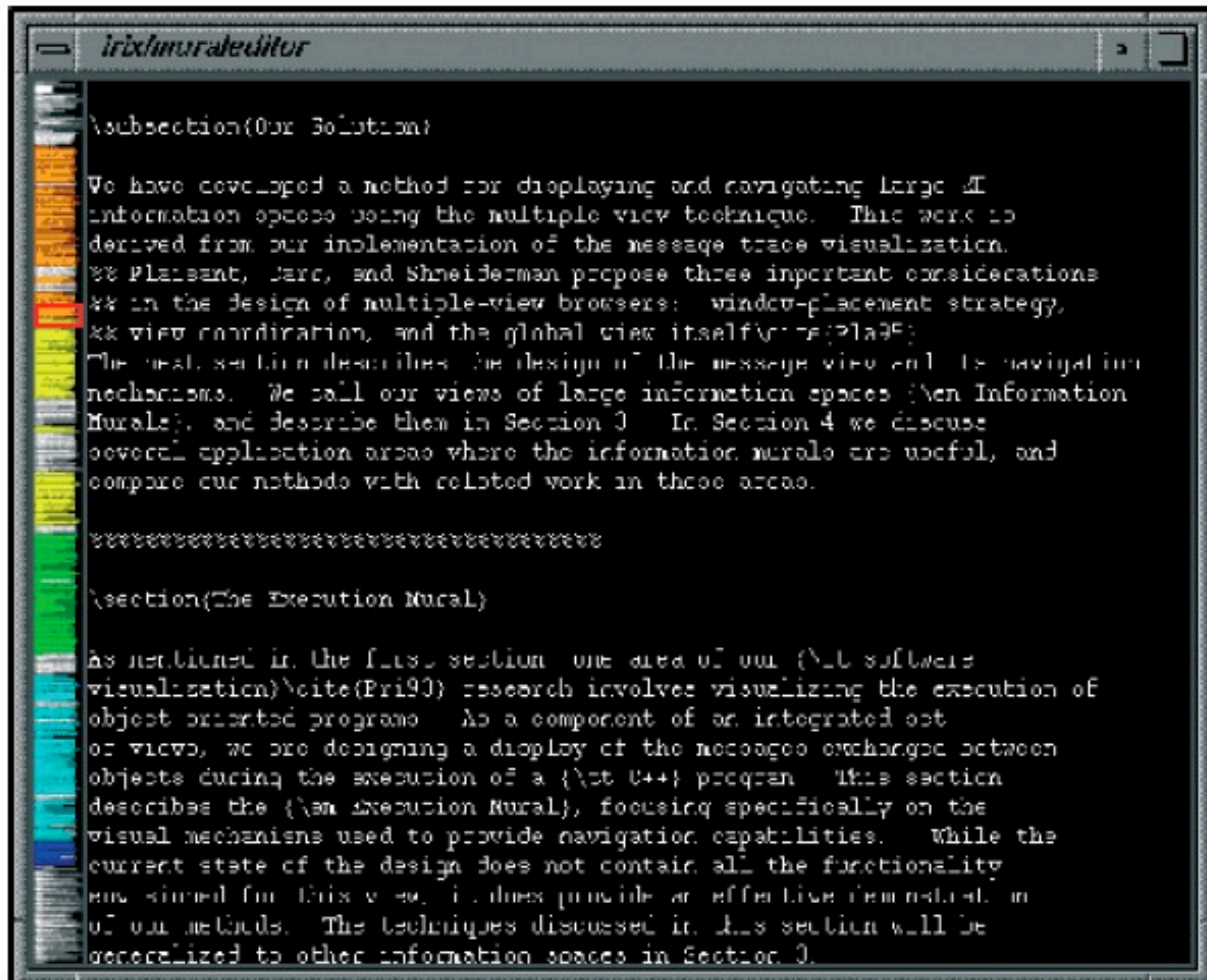

```
irix/muraleeditor
\subsection{Our Solution}
We have developed a method for displaying and navigating large AI
information spaces using the multiple view technique. This work is
derived from our implementation of the message trace visualization.
** Pleasant, Jarc, and Shneiderman propose three important considerations
** in the design of multiple-view browsers: window-placement strategy,
** view coordination, and the global view itself.
The next section describes the design of the message view and its navigation
mechanisms. We call our views of large information spaces (see Information
Murals), and describe them in Section 3. In Section 4 we discuss
several application areas where the information murals are useful, and
compare our methods with related work in those areas.
*****
\section{The Execution Mural}
As mentioned in the first section one area of our (AI software
visualization) research involves visualizing the execution of
object oriented programs. As a component of an integrated set
of views, we are designing a display of the messages exchanged between
objects during the execution of a C++ program. This section
describes the (Execution Mural), focusing specifically on the
visual mechanisms used to provide navigation capabilities. While the
current state of the design does not contain all the functionality
envisaged for this view, it does provide an effective demonstration
of our methods. The techniques discussed in this section will be
generalized to other information spaces in Section 3.
```

Interface Performance

- Task-completion time
 - Navigation on the overview may significantly improve the interface performance
 - E.g. users can directly navigate to locations that are currently not visible on the detail view
 - Drawback: multiple views require time-consuming visual switching between views
- User study by Hornbaek et al. 2002
- 32 participants, counterbalanced within-subjects design
- Browsing and navigation tasks on two maps
- Two semantic ZUIs, one with and one without overview
- Participants were faster with the detail-only interface
- 80% preferred the overview-enhanced interface

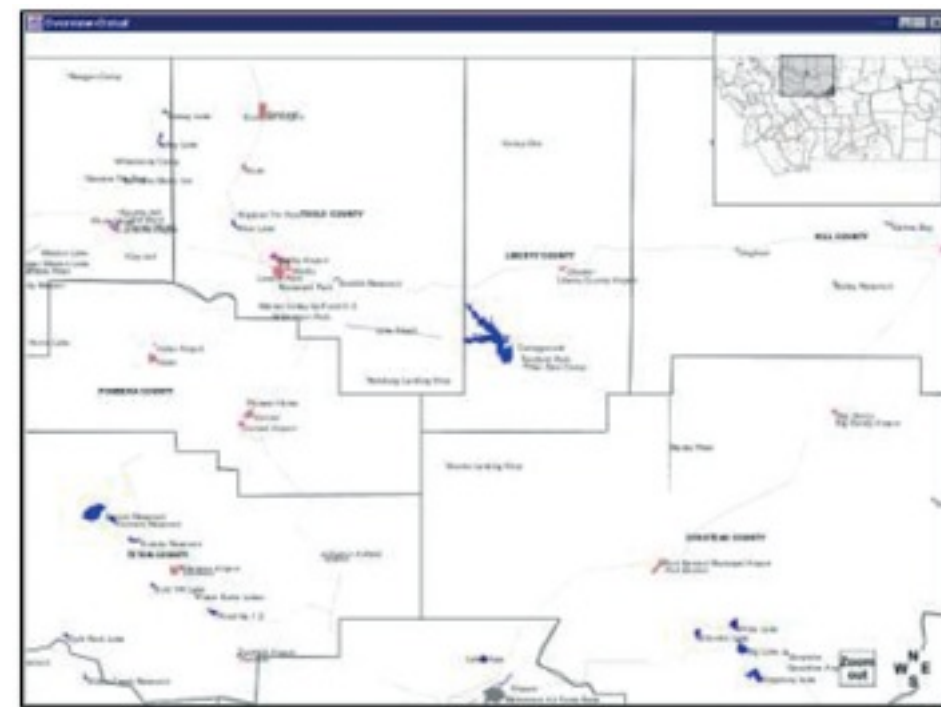

Hornbaek et al. 2002

View Coordination

- Most simple o+d: overview shows a static image of the information space
 - Users are forced to compare the visual cues in the detail view with the cues in the overview
 - For reasonably large and complex information spaces, this approach is hardly usable
- Dynamic overviews
 - Visual cues such as a field-of-view box aid orientation
 - Implies coordination of views
- Coordination (also termed tight coupling)
 - Unidirectional: only one view is interactive
 - Bidirectional: supports user input in both views
- Study by North&Shneiderman2000: coordinated views were found to be 30% to 50% faster than a detail-only interface and a o+d interface with two independent views

View Layout

- Basic side-by-side layout of views require that the available display space is partitioned between the views
- Problem: for both views the usability increases with a growing size
- No general solution for the space tradeoff
- Layout of the views is task-dependent (Plaisant 1995)
 - Open-ended exploration or drawing tasks require a larger detail view
 - Monitoring tasks require a larger overview

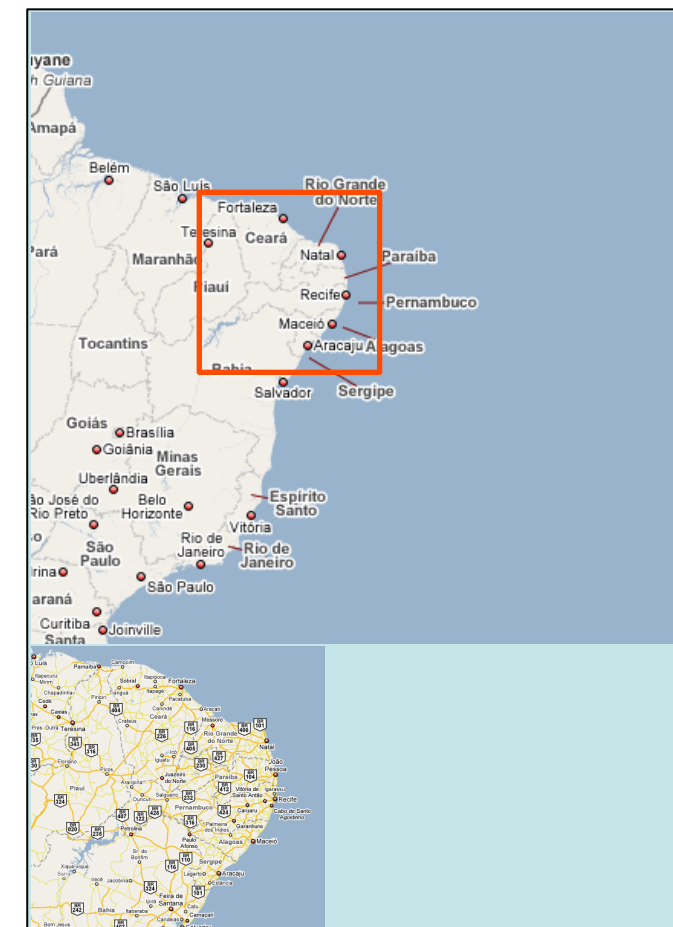
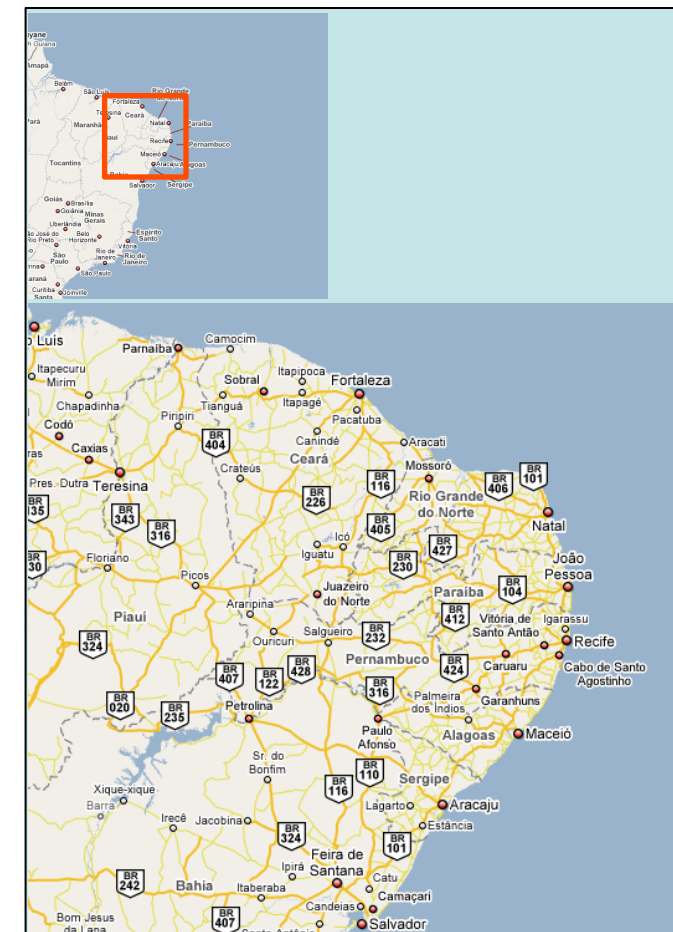

Alternative View Layouts

- Overlapping views
 - Overview overlaps with the detail view (e.g. Acrobat overview)
 - Users can drag and scale the overview view as desired
 - Problem: managing windows is time-consuming and adds extra complexity to the interface
- Automatic overviews
 - System decides when to (temporarily) display an overview
 - How to predict the need for an overview?
 - E.g. extensive zooming and panning on the detail view
 - Malfunction can be highly annoying
- Transparent overviews
 - Can be applied to both overlapping and automatic overviews
 - Problems: increased visual clutter and deteriorated readability of both detail view and overview

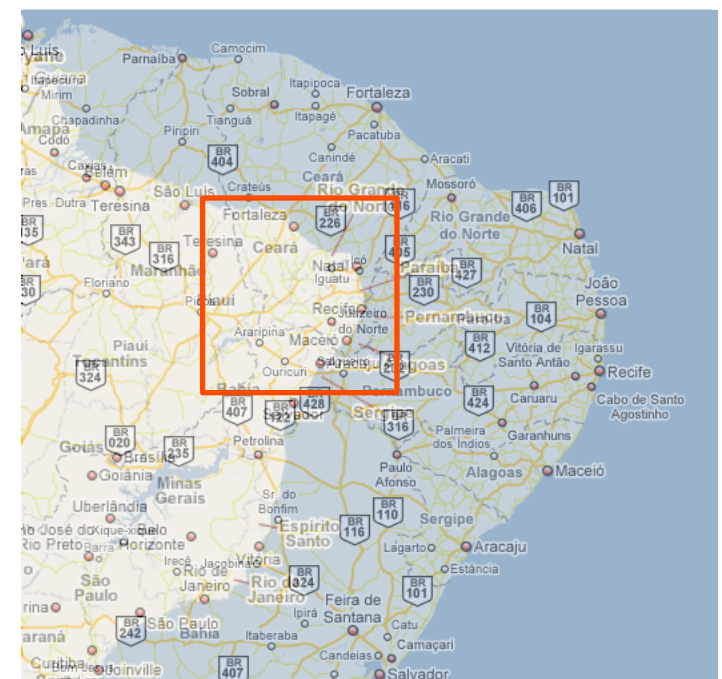
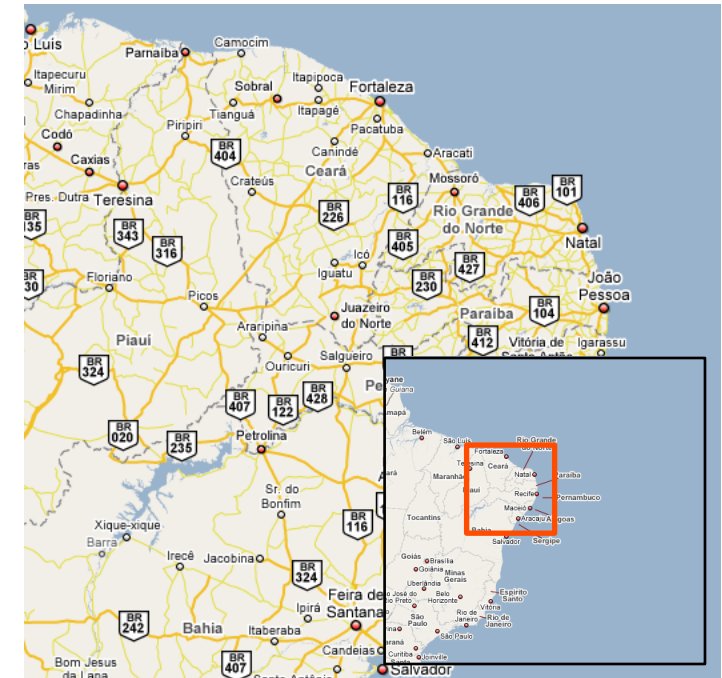

Zoom Factors

- Zoom factor: level of magnification between detail view and overview
- Should be
 - Less than 20 (Plaisant 1995)
 - Between 3 and 30 (Shneiderman & Plaisant 2005)
- Larger zoom factors may require intermediate views

