

context and
task

challenges

Predictive
Models

■ **Systematic
Exploration**

input
technologies

challenges in
interaction
design

output
technologies

Let's recap

- short version of where our standard desktop interface comes from
 - not all tasks can be augmented using this human-computer setup.
 - as the interface moves into the physical world other design factors become prominent, e.g. social aspects.
- **models**
 - why you need them (descriptive, predictive, generative power)
 - morphological approach to describe input devices

continued

Literature: Card et al., "A Morphological Analysis of the Design Space of Input Devices". ACM Transactions on Information Systems, Vol.9, No. 2, 1991

context and task

challenges

Predictive Models

Systematic Exploration

input technologies

challenges in interaction design

output technologies

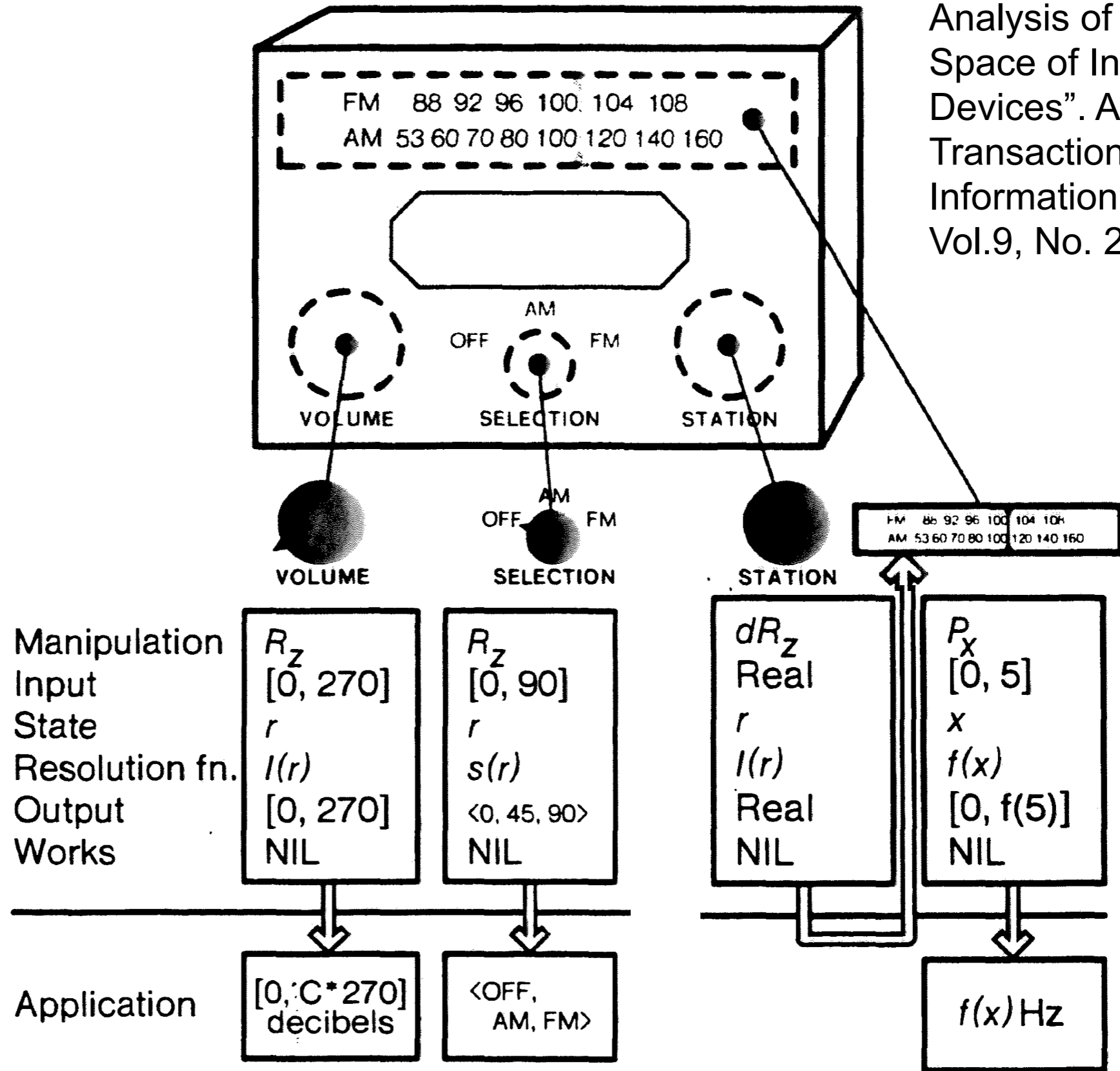

Composition Operators

context and task

challenges

Predictive Models

■ Systematic Exploration

input technologies

challenges in interaction design

output technologies

- merge composition
 - two devices can be composed so that their common sets are merged
- layout composition
 - several devices laid out together in a control panel
- connect composition
 - two devices connected that the output of one is cascaded to the input of the other

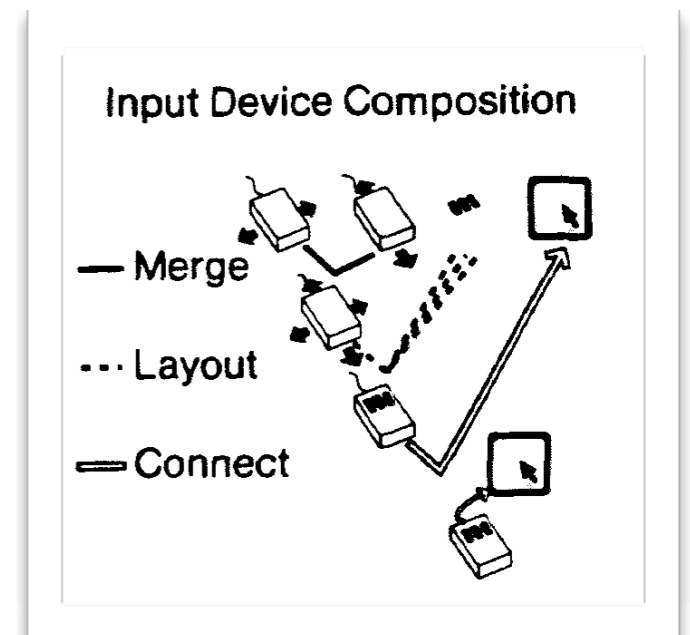

Literature: Card et al., "A Morphological Analysis of the Design Space of Input Devices". ACM Transactions on Information Systems, Vol.9, No. 2, 1991

Desktop

context and
task

challenges

Predictive
Models

■ **Systematic
Exploration**

input
technologies

challenges in
interaction
design

output
technologies



<http://i.computer-bild.de/imgs/1/3/2/0/0/9/4/Spiegelreflexkamera-Nikon-D60-745x566-cf31434ace8e0156.jpg>

Desktop

context and task

challenges

Predictive Models

■ Systematic Exploration

input technologies

challenges in interaction design

output technologies



- Name = $\langle M, In, S, R, Out, W \rangle$
- Wheel = $\langle dR_{ry}, Real, ry, f(ry), Z, \{\} \rangle$

context and task

challenges

Predictive Models

■ Systematic Exploration

input technologies

challenges in interaction design

output technologies



<http://i.computer-bild.de/imgs/1/3/7/0/0/9/4/Spiegelreflexkamera-Nikon-D60-745x566-cf31434ace8e0156.jpg>

5-Minute task:
Formally describe this control element

context and task

challenges

Predictive Models

■ Systematic Exploration

input technologies

challenges in interaction design

output technologies



<http://i.computer-bild.de/imgs/1/3/2/0/0/9/4/Spiegelreflexkamera-Nikon-D60-745x566-cf31434ace8e0156.jpg>

$$\text{NavigationRing}_{xyz} = (\text{FingerPosition}_x \times \text{FingerPosition}_y) \otimes \text{Push}_z$$

R = radius, H= radius of inner hole

$$\text{FingerPosition}_{xy} = \langle P_{xy}, (x,y) \in \text{Real} \mid ((x^2+y^2) < R^2 \cap (x^2+y^2) > H^2) \cup \text{Default}, \text{Default}, f(\text{Default}), \{\text{none}, S1, S2, S3, S4\}, \{\}\rangle$$

$$S1 = (-(R-H)/2, 0), \text{ etc.}$$

$$\text{Default} = (\text{Reststate}_x, \text{Reststate}_y)$$

context and task

challenges

Predictive Models

■ Systematic Exploration

input technologies

challenges in interaction design

output technologies



<http://i.computer-bild.de/imgs/1/3/2/0/0/9/4/Spiegelreflexkamera-Nikon-D60-745x566-cf31434ace8e0156.jpg>

$$\text{NavigationRing}_{xyz} = (\text{FingerPosition}_x \times \text{FingerPosition}_y) \otimes \text{Push}_z$$

R = radius, H= radius of inner hole

$$\text{FingerPosition}_{xy} = \langle P_{xy}, (x,y) \in \text{Real} \mid ((x^2+y^2) < R^2 \cap (x^2+y^2) > H^2) \cup \text{Default}, \text{Default}, f(\text{Default}), \{\text{none}, S1, S2, S3, S4\}, \{\}\rangle$$

$$S1 = (-(R-H)/2, 0), \text{ etc.}$$

$$\text{Default} = (\text{Reststate}_x, \text{Reststate}_y)$$

Visual Description

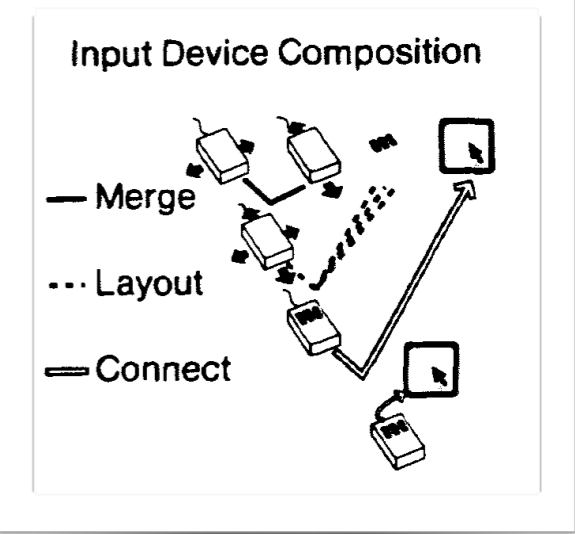

context and task

challenges

Predictive Models

■ Systematic Exploration

input technologies

challenges in interaction design

output technologies

	Linear			Rotary			
	X	Y	Z	rX	rY	rZ	
Position							Angle
Movement							Delta Angle
Force							Torque
Delta Force							Delta torque
	1 10 100 Inf	1 10 100 Inf	1 10 100 Inf	1 10 100 Inf	1 10 100 Inf	1 10 100 Inf	
	Measure			Measure			

Visual Description



context and task

challenges

Predictive Models

Systematic Exploration

input technologies

challenges in interaction design

output technologies

	Linear				Rotary			
	X	Y	Z	rX	rY	rZ		
Position P			①				Volume	Angle R
Movement dP	Mouse		③			Station	Selection	Delta Angle dR
Force F								Torque T
Delta Force dF								Delta torque dT
	1 10 100 Inf	1 10 100 Inf	1 10 100 Inf	1 10 100 Inf	1 10 100 Inf	1 10 100 Inf		
	Measure	Measure	Measure	Measure	Measure	Measure		

Importance for interaction design?

context and task

challenges

Predictive Models

Systematic Exploration

input technologies

challenges in interaction design

output technologies

- Morphological Approach
 - cope with complexity, cope with large number of alternatives.
- Descriptive power (how?)
- Generative power (how?)

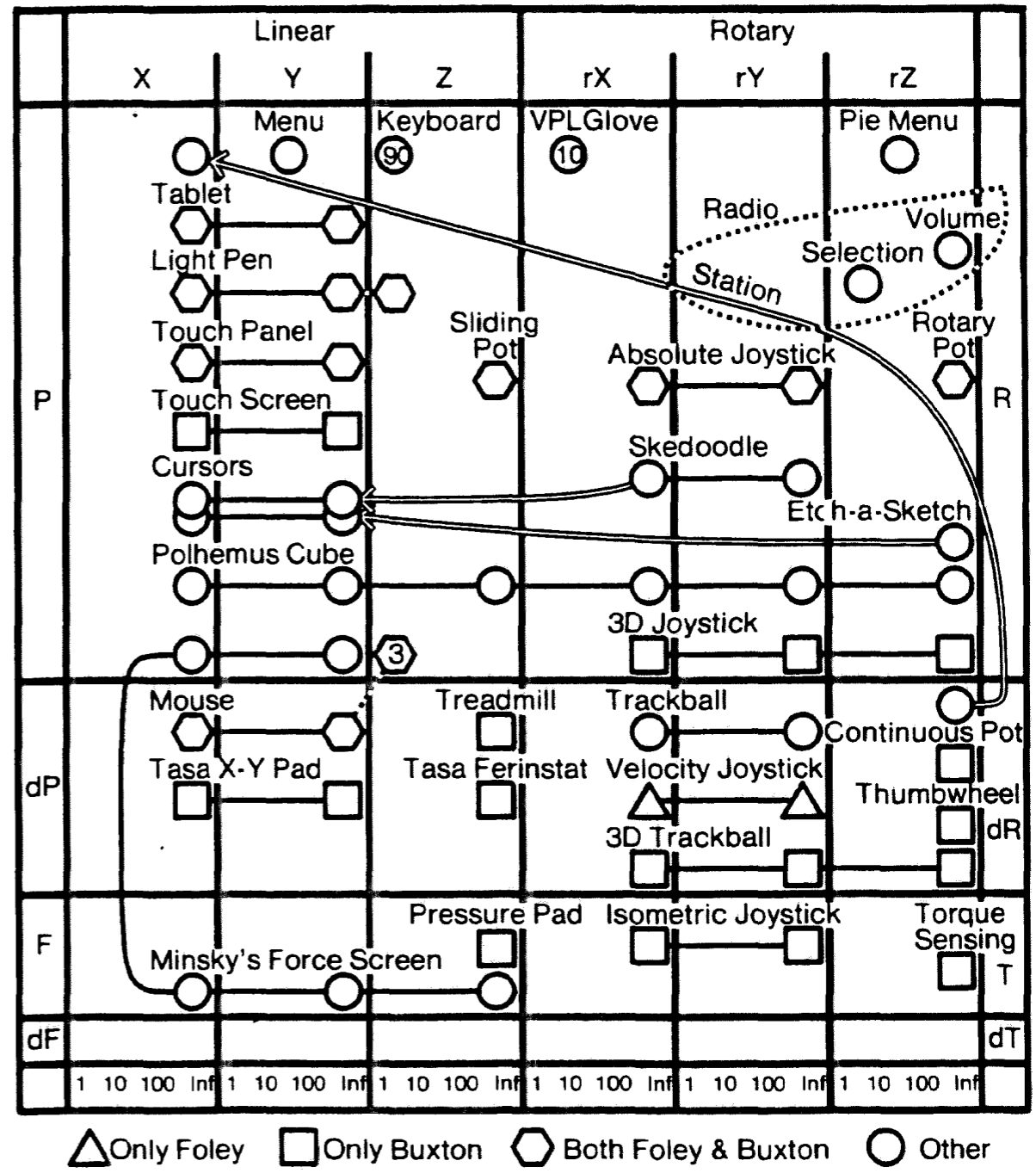

context and
task

challenges

input
technologies

challenges in
interaction
design

output
technologies

Take-away Message

- models are important
 - research:
 - communicate interdisciplinary field
 - establish understanding of a phenomenon
 - work on systematic ways of exploring designs
 - industry:
 - can reduce costs of testing different designs
 - generate ideas for the next product
- require models that enable
 - description
 - prediction
 - generation of new ideas.
- reality vs. model

Desktop Environments

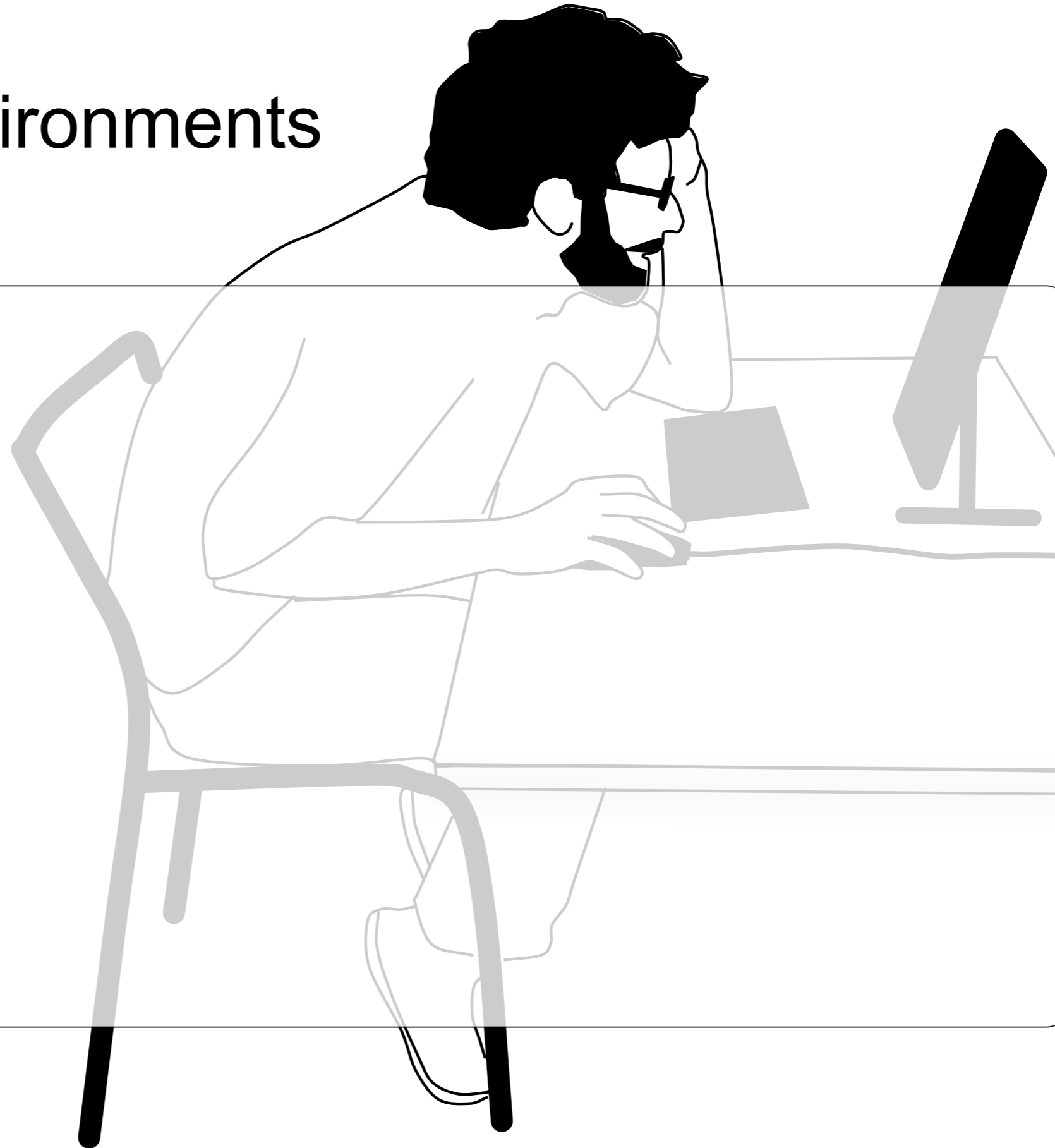

context and task

challenges

input technologies

challenges in interaction
design

output technologies

context and
task

challenges

**input
technologies**

challenges in
interaction
design

output
technologies

Technological Advancement

- 4 groups
 - **Visionaries**
 - **Pioneers**
 - Adapters
 - Followers
- **Bill Buxton's Milestones in Computer Input Devices: an informal timeline**
 - captures some of the key events/players that helped drive the evolution of range of input devices.
 - “neither whole story, nor even the true story... it's a personal view.”
 - Restructuring:
 - desktop: mouse, touch, pen
 - out-of-the-box: body, glove

<http://www.billbuxton.com/inputTimeline.html>

context and
task

challenges

input
technologies

challenges in
interaction
design

output
technologies

Visionary: Vannevar Bush



- “The Inscrutable Thirties”, utopian way of criticizing the present way of handling information
 - support innovation in knowledge transfer and storage
- 1939, introduced *Memex* in “Mechanization and the Record”.
 - machine that helps manage the record, create organization, control intellectual information
 - “he calls for a new relationship between thinking man and the sum of our knowledge.”

Literature:

Vannevar Bush. 1945. As we may think. URL: <http://www.ps.uni-saarland.de/~duchier/pub/vbush/vbush.shtml>

context and
task

challenges

input
technologies

challenges in
interaction
design

output
technologies

Dealing with information

- “Mendel’s concept of the laws of genetics was lost to the world for a generation because his publications did not reach the few who were capable of grasping and extending it.”
- “The difficulty seems to be not so much that we publish [...] but rather that publication has been extended far beyond our present ability to make real use of the record.”
- “summation of human experience is being expanded at a prodigious rate”
- the means we use to make our way through this maze to the important items should adapt.

context and
task

challenges

input
technologies

challenges in
interaction
design

output
technologies

Deal with advanced problems

- “A mathematician is not [...] a man who can readily perform the transformation of equations by the use of calculus. He is primarily an individual who is skilled in the use of symbolic logic on a high plane, and especially he is a man of intuitive judgment in the choice of the manipulative processes he employs.”
- turn over to his mechanism, just as he turns over to car mechanism instead of thinking about what is going on under the hood.
- only then he can effectively contribute to advanced problems.

Space Issues

context and
task

challenges

input
technologies

challenges in
interaction
design

output
technologies

- “Consider film of the same thickness as paper, although thinner film will certainly be usable. Even under these conditions there would be a total factor of 10,000 between the bulk of the ordinary record on books, and its microfilm replica.”

Literature:

Vannevar Bush. 1945. As we may think. URL: <http://www.ps.uni-saarland.de/~duchier/pub/vbush/vbush.shtml>

Matter of selection

context and
task

- mechanisms by libraries

challenges

- lack of development of devices for their use

**input
technologies**

- artificiality of index system (alphabetically, numerically)

challenges in
interaction
design

- having found one item, emerge from system and re-enter on a new path.
- human mind does not work like this.

output
technologies

- selection by association rather than indexing

Literature:

Vannevar Bush. 1945. As we may think. URL: <http://www.ps.uni-saarland.de/~duchier/pub/vbush/vbush.shtml>

context and
task

challenges

**input
technologies**

challenges in
interaction
design

output
technologies

“Consider a future device for individual use, which is a sort of mechanized private file and library. It needs a name, and, to coin one at random, “memex” will do. A memex is a device in which an individual stores all his books, records, and communications, and which is mechanized so that it may be consulted with exceeding speed and flexibility. It is an enlarged intimate supplement to his memory.... [A]ssociative indexing, the basic idea of which is a provision whereby any item may be caused at will to select immediately and automatically another, [is] the essential feature of the memex. The process of tying two items together is the important thing.”

Literature:

Vannevar Bush. 1945. As we may think. URL: <http://www.ps.uni-saarland.de/~duchier/pub/vbush/vbush.shtml>

Memory Extender (Memex)

context and task

challenges

input technologies

challenges in interaction design

output technologies

- personal hard drive for organizing information
- emphasizes the importance of hyperlinks and metadata (information about information)
- based on associations to navigate
- screen for convenient reading, keyboard, sets of buttons and levers.
- distribution via tapes
- juxtaposition of information, add notes & comments

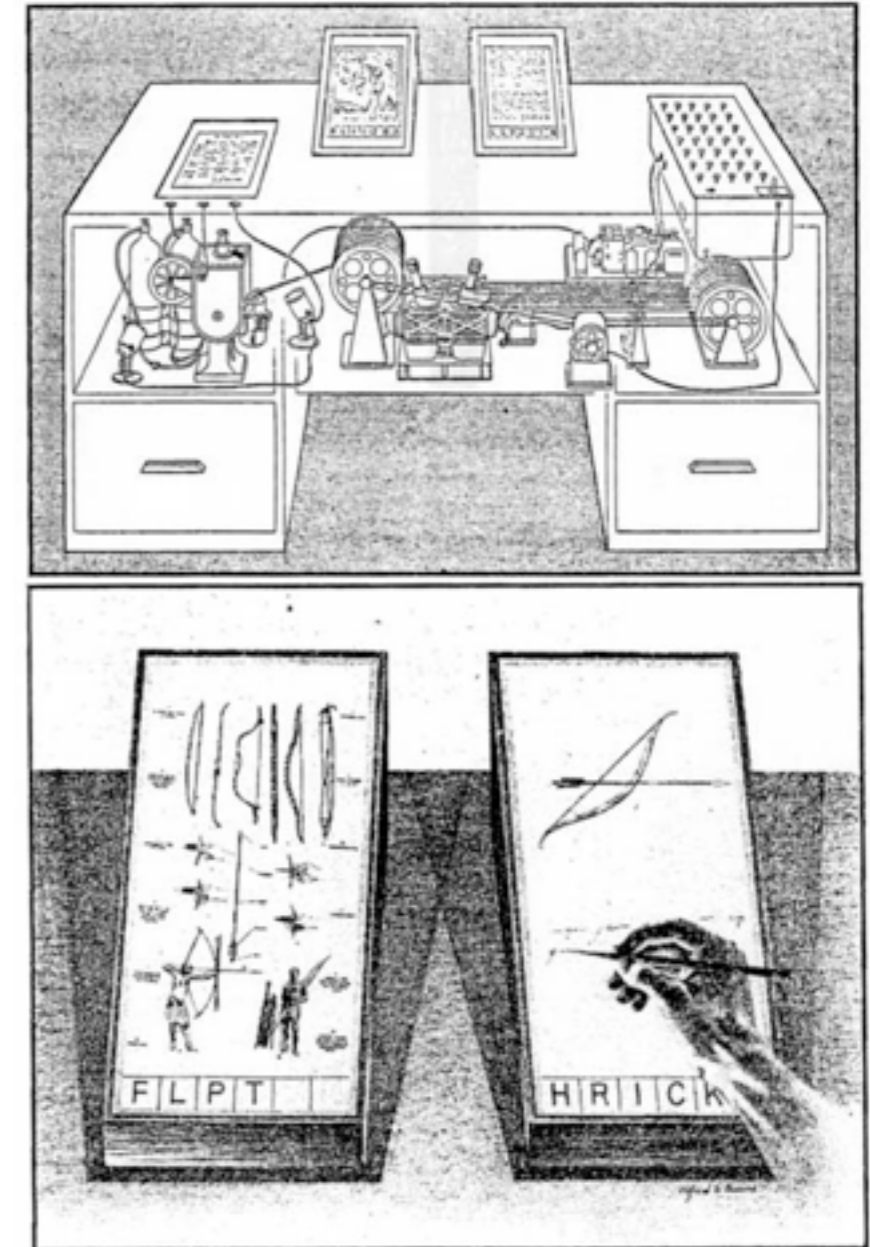

Literature:

Vannevar Bush. 1945. As we may think. URL: <http://www.ps.uni-saarland.de/~duchier/pub/vbush/vbush.shtml>

context and task

challenges

input technologies

challenges in interaction design

output technologies

Light Gun: Robert Everett

- early 1950s
- reads the position of a dot on the screen of the Whirlwind
- identified aircrafts on the CRT of SAGE air defense computer (1956)

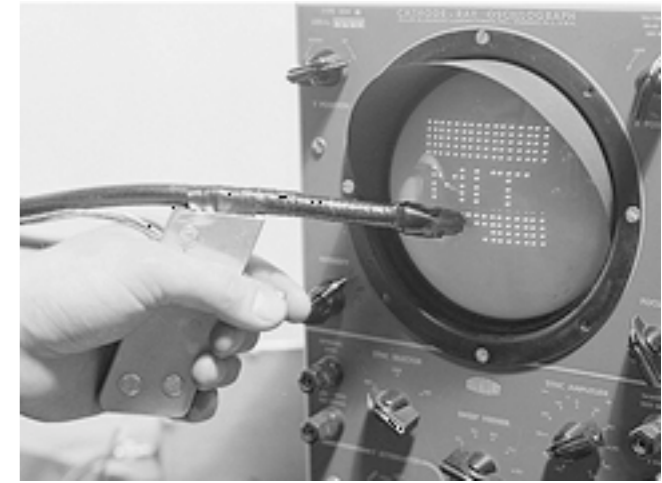

Photo from Computer Desktop Encyclopedia, © 2000 The MITRE Corporation Archives.



<http://www.computerhistory.org/collections/catalog/102645102>

context and
task

challenges

**input
technologies**

challenges in
interaction
design

output
technologies

Trackball (1952)

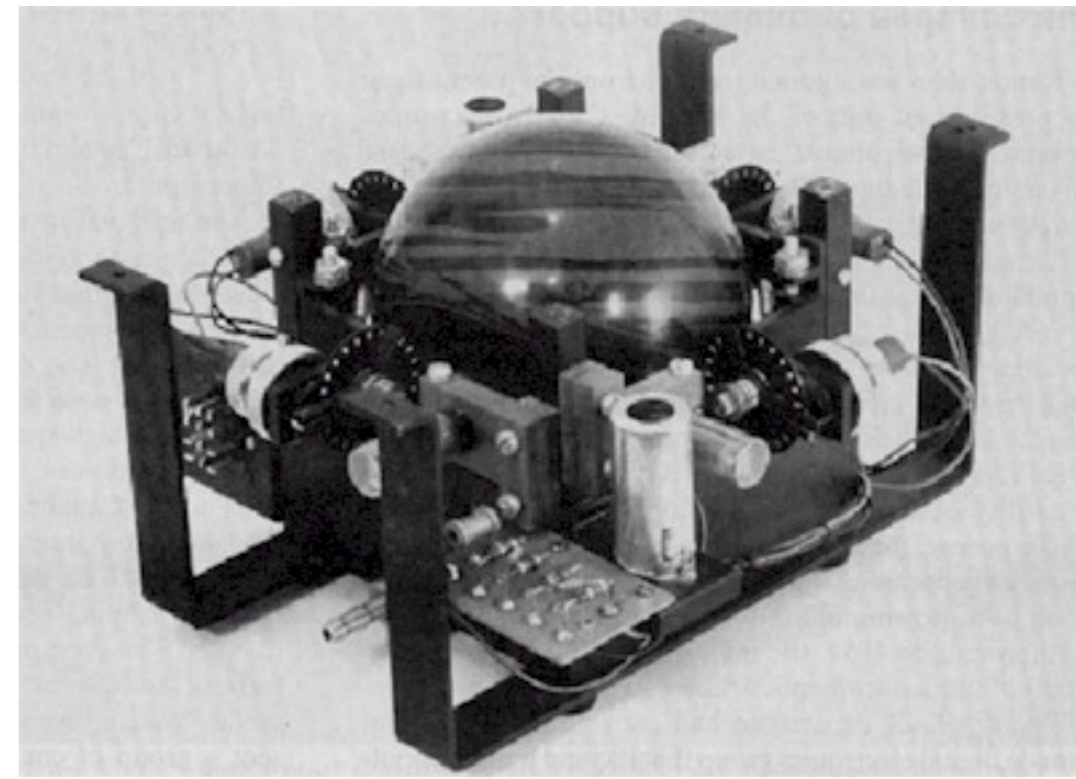

<http://www.billbuxton.com/inputTimeline.html>

- developed for DATAR computer
- first prototype used a bowling ball from the canadian game (five-pin bowling)
 - ball supported by tiny jets of air to minimize friction and keep it floating despite its weight.

context and task

challenges

input technologies

challenges in interaction design

output technologies

Lightpen (1957)



<http://www.billbuxton.com/inputTimeline.html>

- stylus shaped follow-up of a Light Gun
- first interaction with a pen-shaped device on a screen

Lightpen (Sketchpad by Ivan Sutherland)

context and task

challenges

input technologies

challenges in interaction design

output technologies

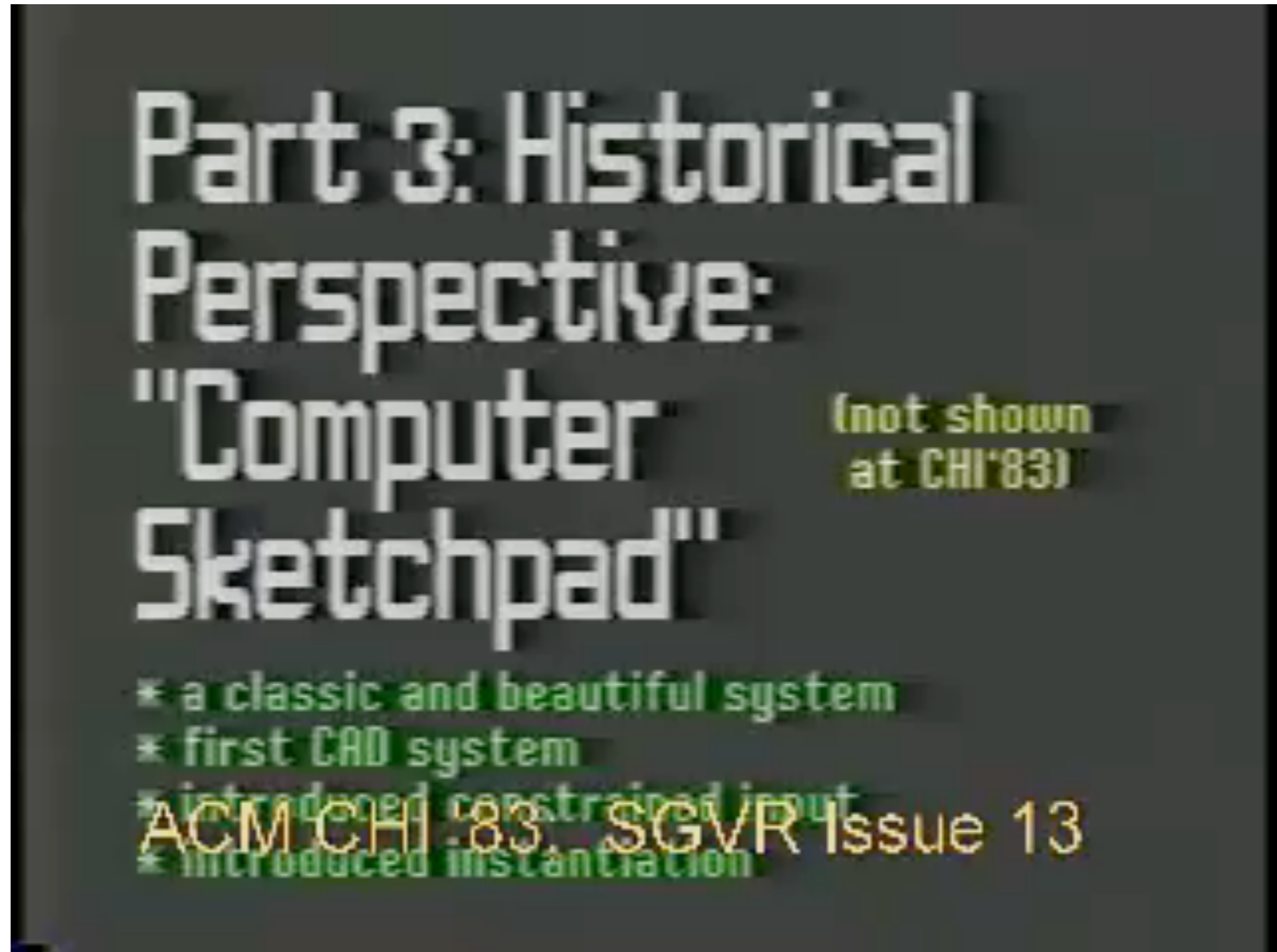

https://www.youtube.com/watch?v=USyoT_Ha_bA

context and task

challenges

input technologies

challenges in interaction design

output technologies

Graphics tablet with stylus

- 1963 Rand Tablet
- stylus tablet



<http://www.billbuxton.com/inputTimeline.html>

Mouse (1964)

- Douglas Engelbart
- patented in 1967
- demoed in 1968
- integrated in the computer system NLS (oN-Line System)

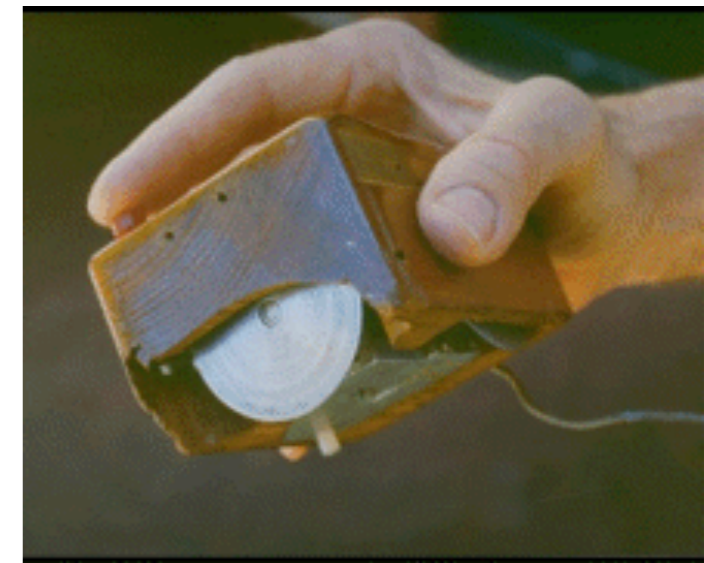

<http://www.billbuxton.com/inputTimeline.html>

Mother of all Demos (1968)

context and task

challenges

input technologies

challenges in interaction design

output technologies

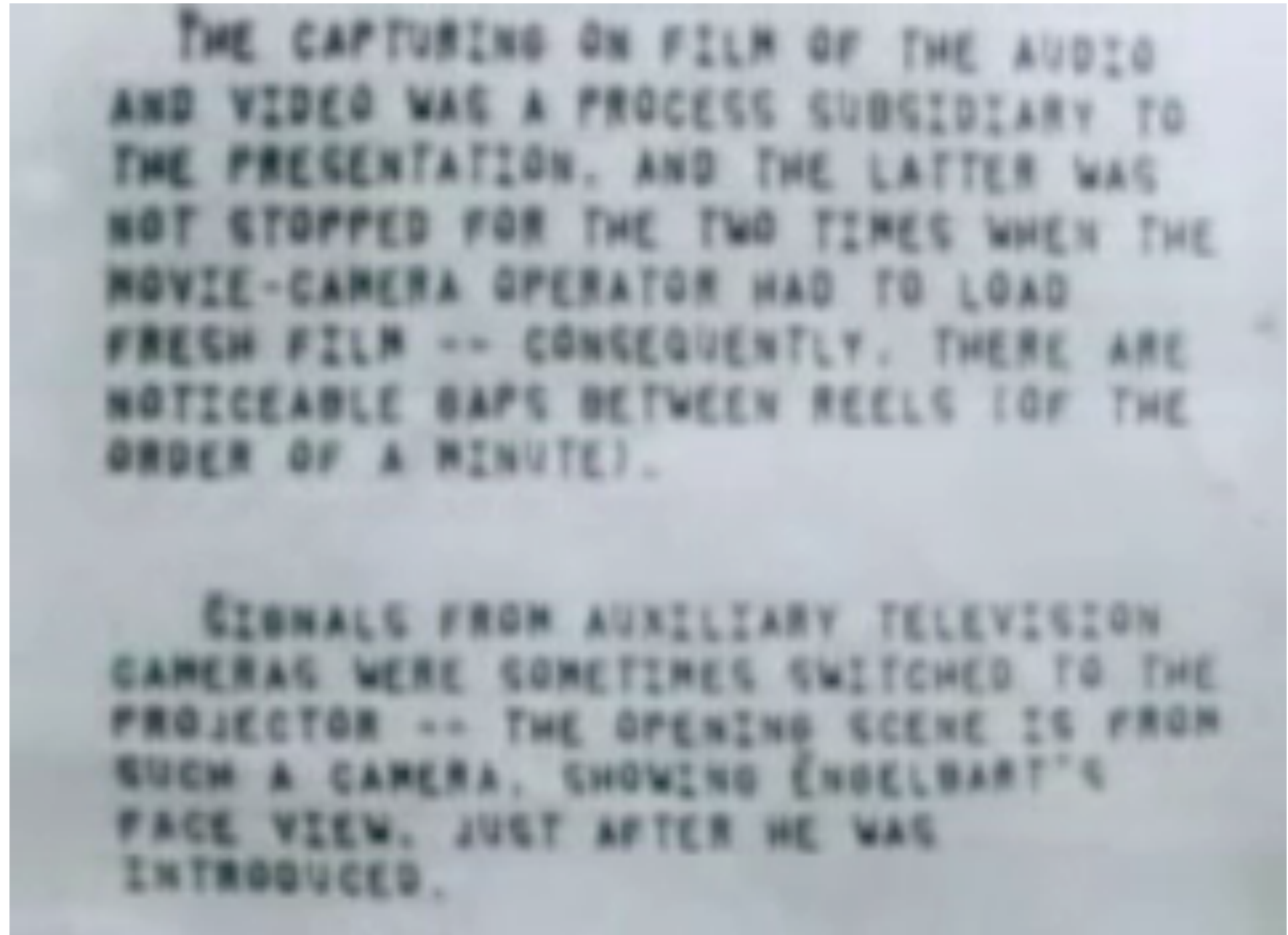

Mother of all Demos (1968)

context and task

challenges

input technologies

challenges in interaction design

output technologies

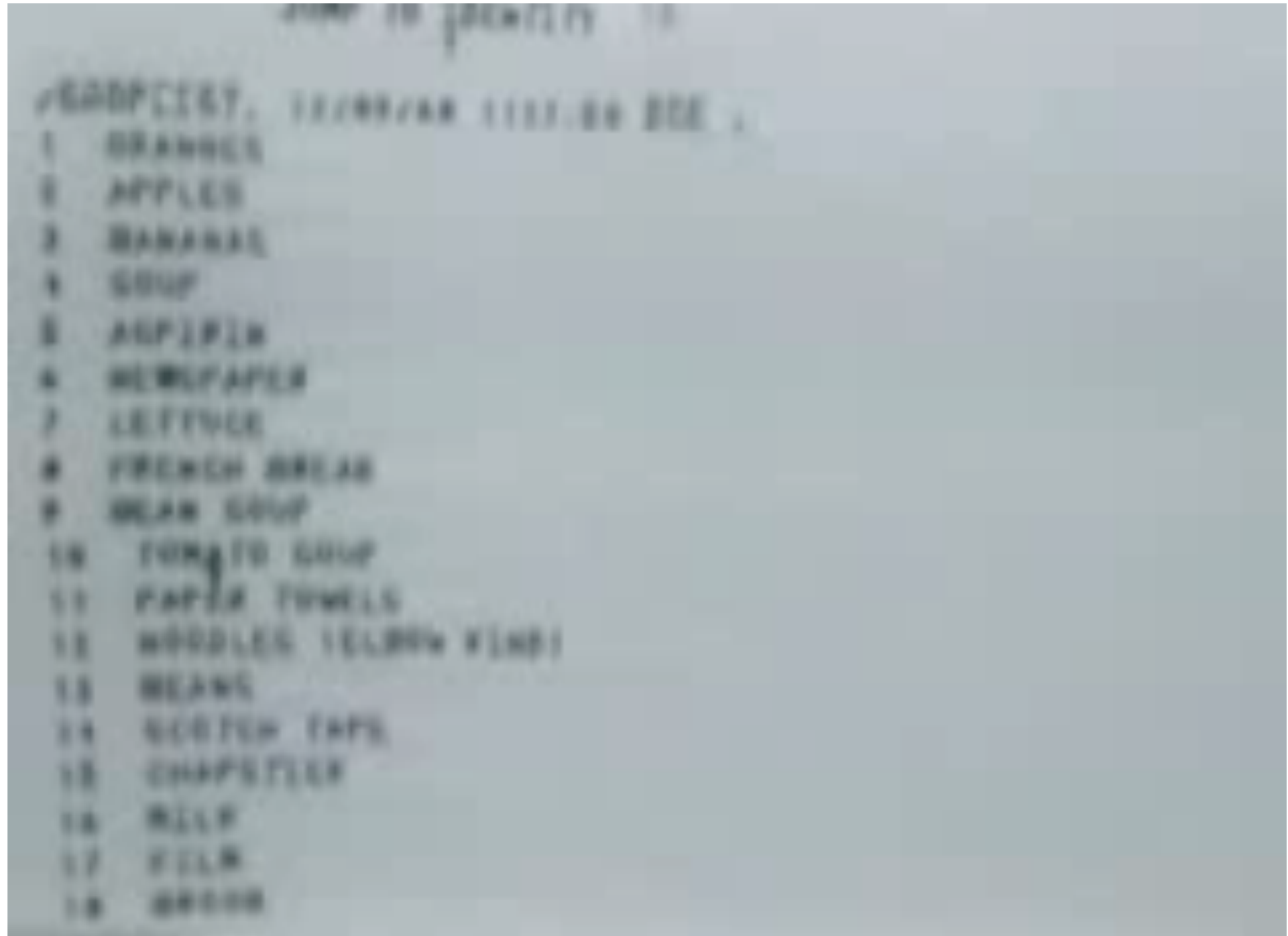

context and
task

challenges

**input
technologies**

challenges in
interaction
design

output
technologies

Mother of all Demos (1968)

- what are the key aspects Engelbart introduces?
 - word processing (copy, cut, paste, file creation)
 - formatting
 - hierarchical view control
 - cross reference
 - shared-screen teleconferencing system, collaboration over distance.

Touch Screen Technology



<http://www.billbuxton.com/inputTimeline.html>

context and task

challenges

input technologies

challenges in interaction design

output technologies

- first description in 1965 using capacitive touch technology
- first widely deployed touch screen technology
 - PLATO Computer Assisted Instruction system
 - deployed in schools
 - sensed position by the finger interrupting light beams that ran parallel to the surface of the computer screen.



Photo courtesy of the Archives of the University of Illinois, Urban Champaign. Found in RS: 39/2/20, Box COL 13, Folder COL 13-13 Computer Ed. Research Lab / PLATO 1952-74

context and task

challenges

input technologies

challenges in interaction design

output technologies

Glove-based Keyboard

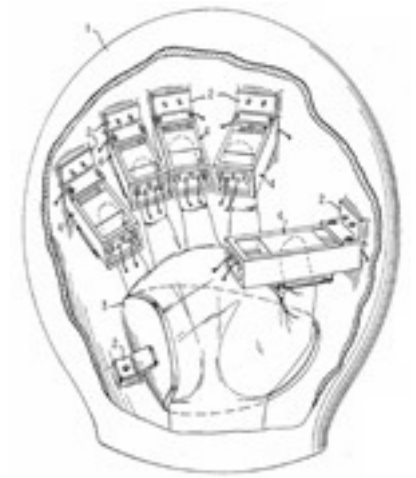

<http://www.billbuxton.com/inputTimeline.html>

- Seiberl et al. 1963 (research)
 - shaped like a boxing glove
 - similar to chord keyboard for text input
- Nintendo Power Glove 1989 (market)
 - flex sensing
 - single-axis motion detection
 - buttons
- Thumbcode (1998)
 - Stanford University
 - three segments for the 4 fingers



<http://www.keyglove.net/resources/similar/>



context and task

challenges

input technologies

challenges in interaction design

output technologies

- embodied counting in some cultures
 - our culture: basis 10
 - babylonian: basis 12
 - papua new guinean: 1 - 37



<http://www.keyglove.net/resources/similar/>

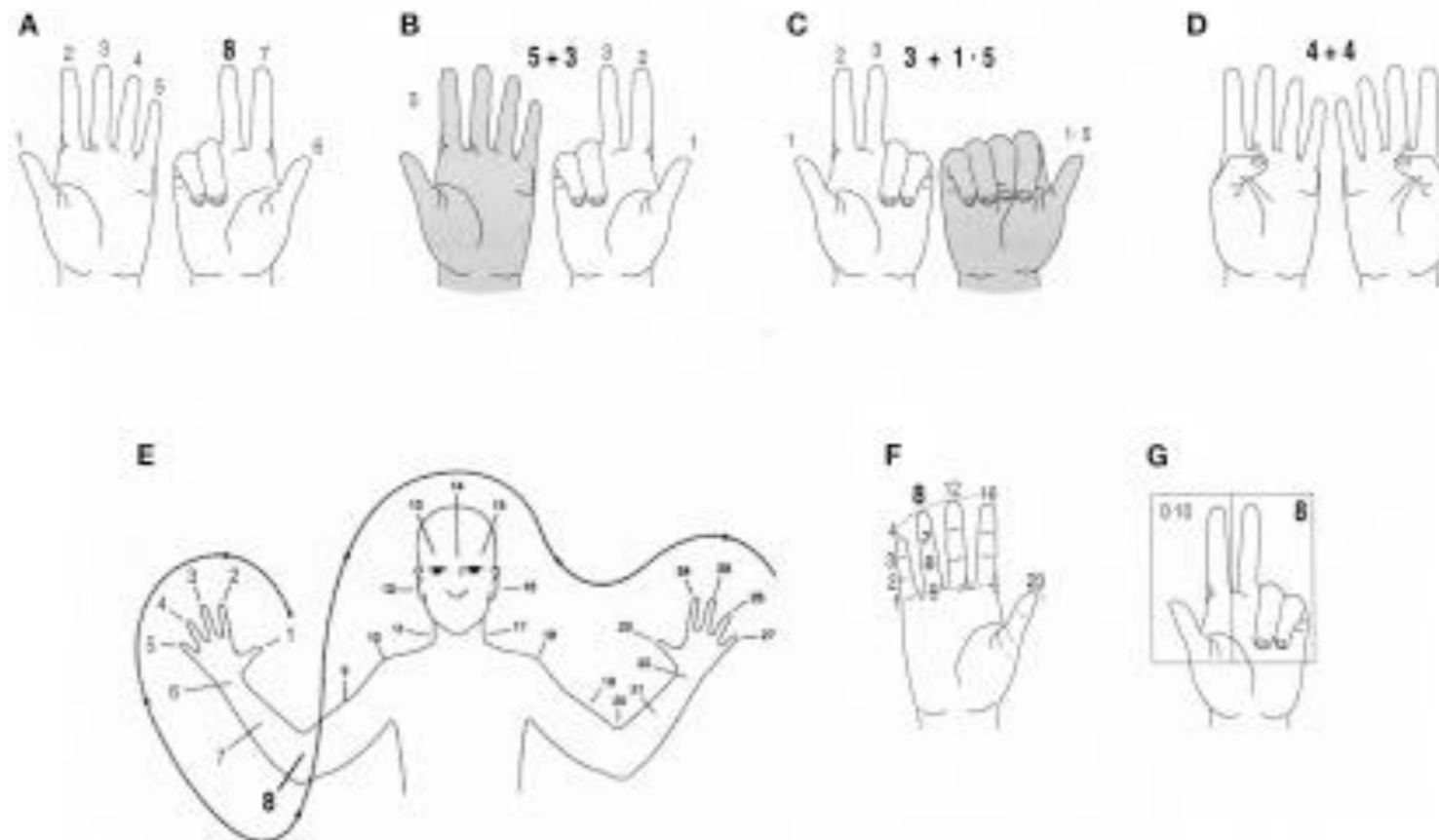

Body input movements

- 1982 Zimmerman's patent for an optical flex sensor.
 - sewn into gloves or suit to sense amount of flex of joints.



<http://www.billbuxton.com/inputTimeline.html>

- 1983 Myron Krueger's Videoplace

Videoplace 1988

context and
task

challenges

**input
technologies**

challenges in
interaction
design

output
technologies



<http://www.youtube.com/watch?v=dmmxVA5xhuo>

take away message

context and
task

– visionaries, pioneers curve between research and
industry

challenges

- Everett Rogers: investigates how/why and how fast a new idea or technology spread through a culture. (Diffusion of Innovations)

**input
technologies**

- Steve Johnson: Where good ideas come from

challenges in
interaction
design

– shared patterns in environments where people are creative

– an idea is a network, new configuration never formed before

output
technologies

Literature: <http://design.osu.edu/carlson/history/lesson1.html>