



OPEN LAB DAY

05.12.13, 18:00 bis 22:00
Amalienstraße 17

www.medien.ifi.lmu.de/openlab

Mobile Technologies

context and task

challenges

input technologies

challenges in interaction
design

output technologies

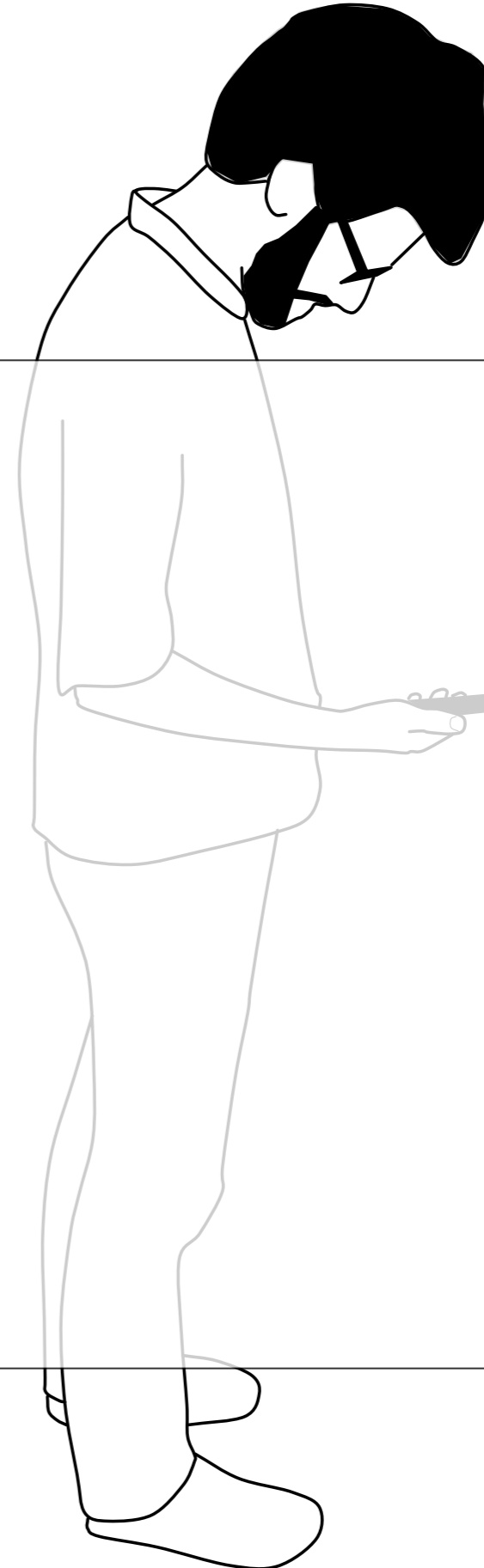

context and
task

challenges

input
technologies

challenges in
interaction
design

output
technologies

Theories and Models

- Device Support
 - how HCI research started to consider the kinematic chain
 - spatial relationship to the device affects interaction performance and perceived comfort
 - BiTouch Design Space, extension of Guiard's theory
- Gestural Input
 - what we lose when moving from keyboard and mouse and direct touch interaction
 - missing standards, how to describe gestures?
 - gesture documentation
 - physical approach to gestures
- Hand Occlusion
 - how a controlled experiment can help you to come up with an approximate model of your hand occlusion
 - how that inspires design of interaction techniques
- Pointing
 - how to describe the imprecision by extending Fitt's law

Proton++ Gesture

- describe a gesture as regular expression over these touch event symbols

context and task

challenges

Device Support

$$E_{TID}^{A_1:A_2:A_3\dots}$$

where $E \in \{D,M,U\}$, attribute values $A_1:A_2:A_3$, A_1 corresponds to first attribute etc.

Gestural Input

input technologies

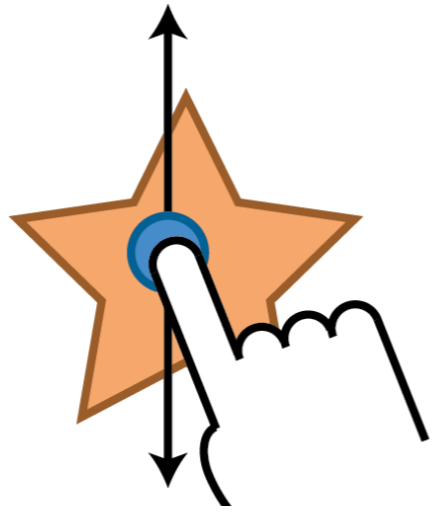

$$D_1^{s:N|S} M_1^{s:N|S} * U_1^{s:N|S}$$

challenges in interaction design

$$(D_1^{s:N} | D_1^{s:S})(M_1^{s:N} | M_1^{s:S}) * (U_1^{s:N} | U_1^{s:S})$$

output technologies

consider attributes:
hit-target shape,
direction

Literature: Kin, K. et al. "Proton++: A Customizable Declarative Multitouch Framework", UIST 2012

Proton++

- Allow holding touch
 - e.g. for calling callback “paste”

context and task

challenges

input technologies

challenges in interaction design

output technologies

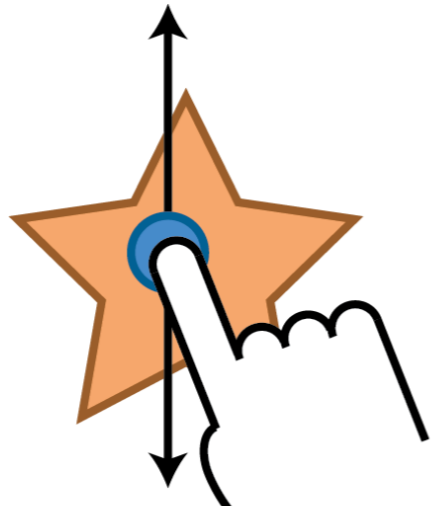
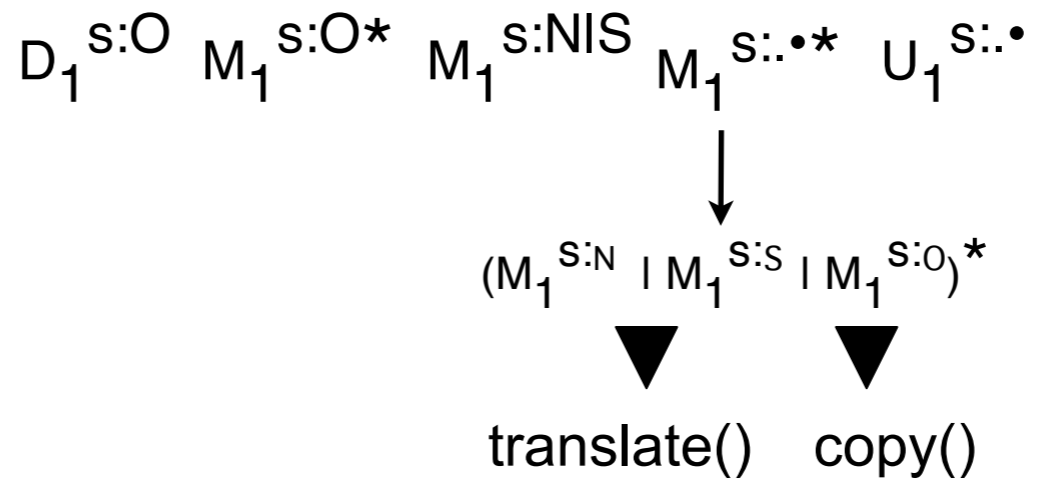

consider attributes:
hit-target shape,
direction

$A_1 \in \{s\}$, s = star element
 $A_2 \in \{N, S, O\}$, O = hold touch

Occlusion

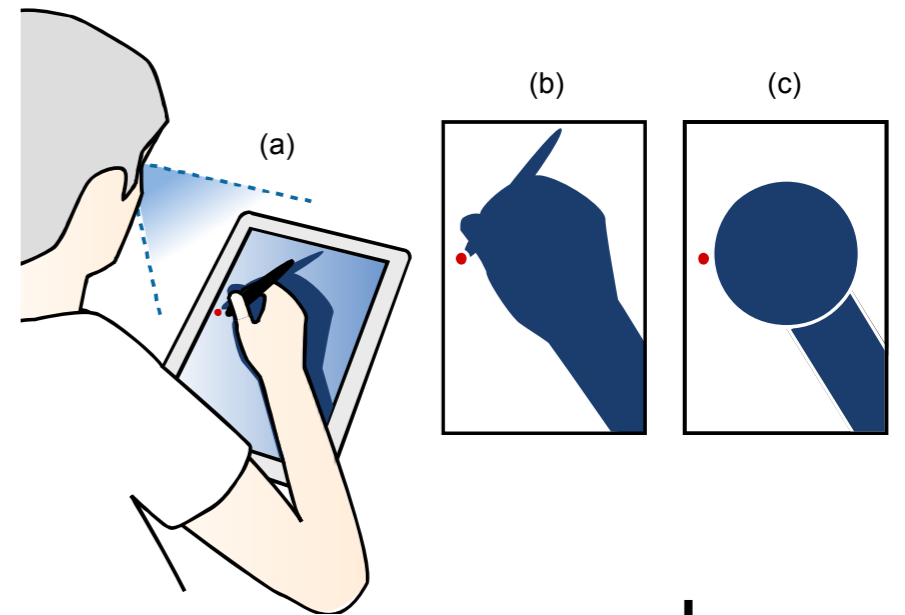

context and task

challenges

Device Support

Gestural Input

Occlusion

input technologies

challenges in interaction design

output technologies

- **problem:** system generated messages may be positioned under the user's hand.
- **one approach:** experimental study using a novel combination of video capture, augmented reality marker tracking, and image processing techniques to capture *occlusion silhouettes*.
- **result:** five parameter geometric model which matches the silhouette with larger precision than the simple bounding box approach
- **useful for *occlusion aware interfaces***

Literature: Vogel, D. et al. (2009). *Hand Occlusion with Tablet-sized Direct Pen Input*, CHI'09

Vogel's Controlled Experiment

context and task

challenges

Device Support

Gestural Input

Occlusion

input technologies

challenges in interaction design

output technologies

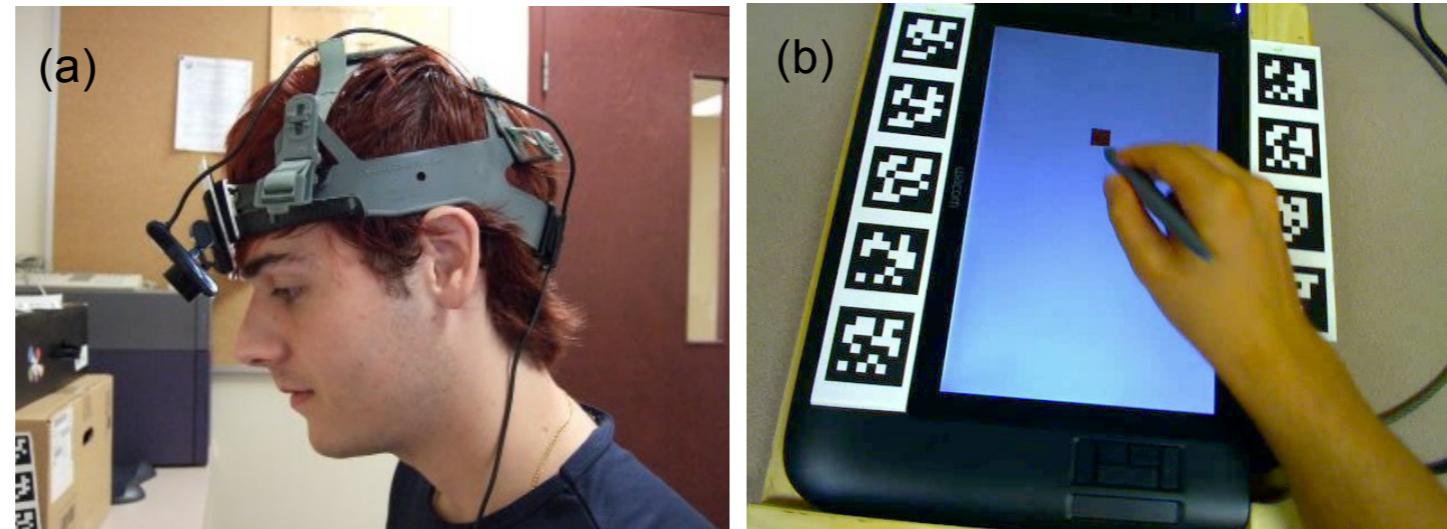

- goal: measure size and shape of occluded area of a tablet-sized display.
- home target: on the far right side
- measurement target: positioned somewhere on an invisible grid (7 x 11 = 77 different locations)

Literature: Vogel, D. et al. (2009). *Hand Occlusion with Tablet-sized Direct Pen Input*, CHI'09

Image Processing

context and task

challenges

Device Support

Gestural Input

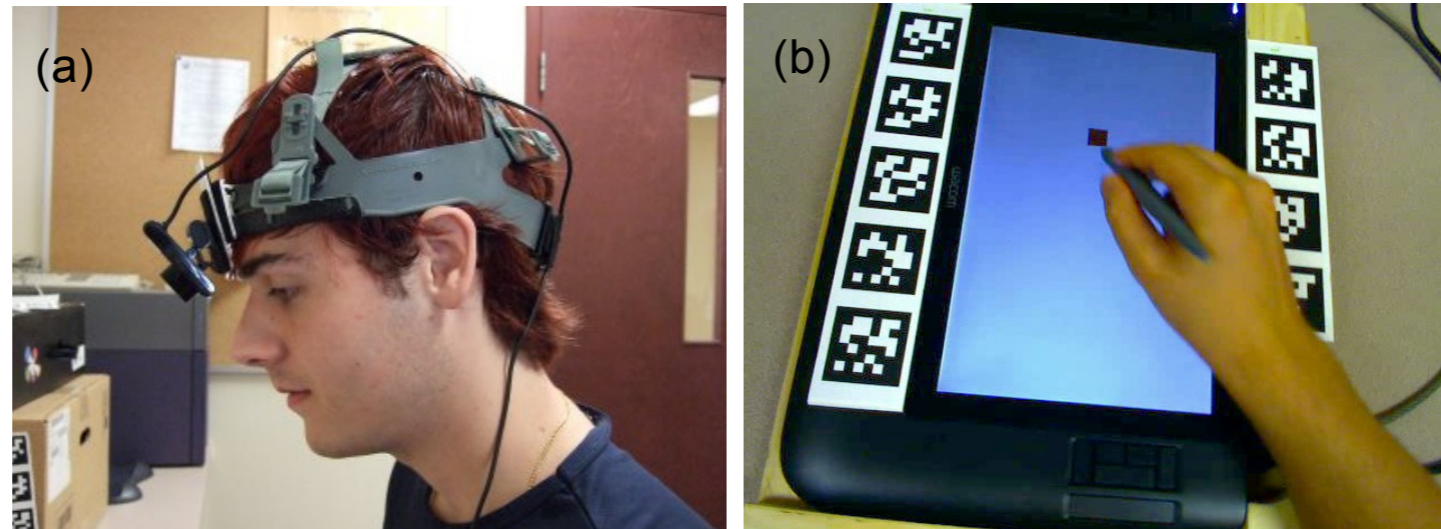

Occlusion

- Frame extraction: video frames taken between successful down and up pen event.
 - synchronize video and data log similar to a movie clapperboard: blend in a large red square containing a unique number.
- Rectification: track fiducial and determine screen corners
- Isolation: blur filter (noise reduction) + extract blue color channel + applied threshold to create an inverted binary image.

input technologies

challenges in interaction design

output technologies

Literature: Vogel, D. et al. (2009). *Hand Occlusion with Tablet-sized Direct Pen Input*, CHI'09

Image Processing

context and task

challenges

Device Support

Gestural Input

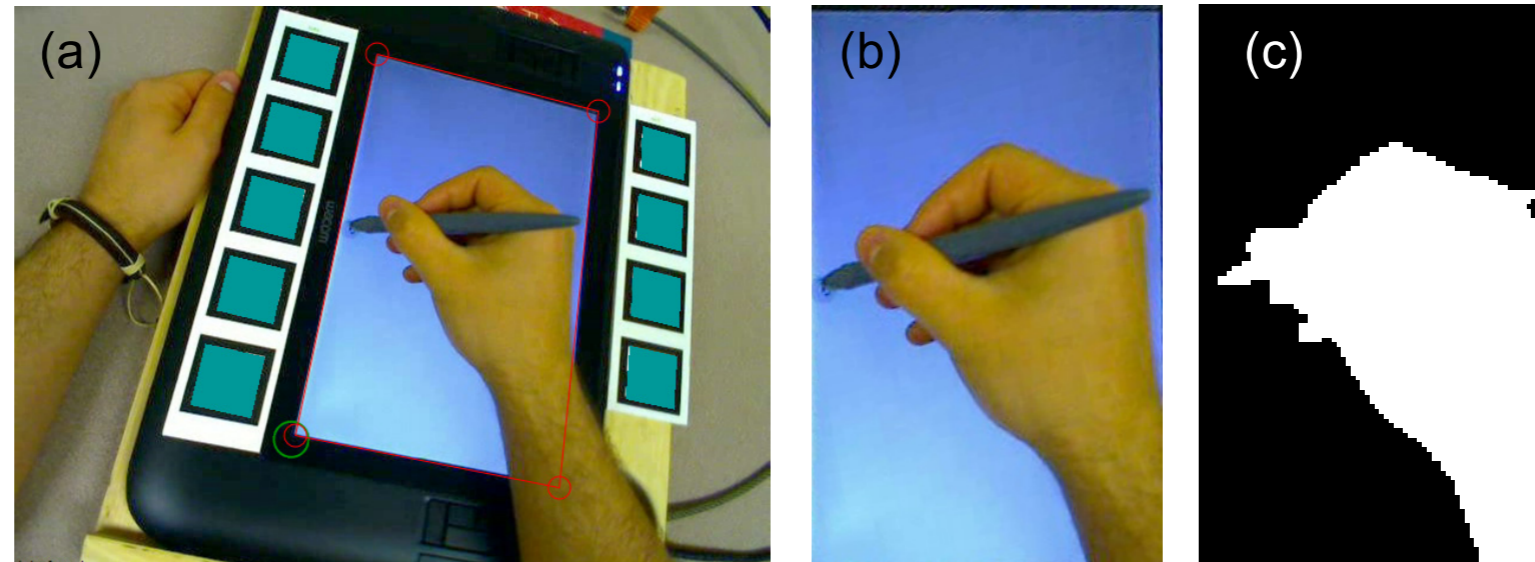

Occlusion

- Frame extraction: video frames taken between successful down and up pen event.
 - synchronize video and data log similar to a movie clapperboard: blend in a large red square containing a unique number.
- Rectification: track fiducial and determine screen corners
- Isolation: blur filter (noise reduction) + extract blue color channel + applied threshold to create an inverted binary image.

Literature: Vogel, D. et al. (2009). *Hand Occlusion with Tablet-sized Direct Pen Input*, CHI'09

input technologies

challenges in interaction design

output technologies

context and task

challenges

Device Support

Gestural Input

Occlusion

input technologies

challenges in interaction design

output technologies

Results

- largest occlusion when tapping the top left corner (occlusion rate: 38.8%)
- identified 3 grips
- large within-subject consistency in occlusion shape.
- “can we find a simple geometric model that could describe the general shape and position of the occlusion silhouettes?”

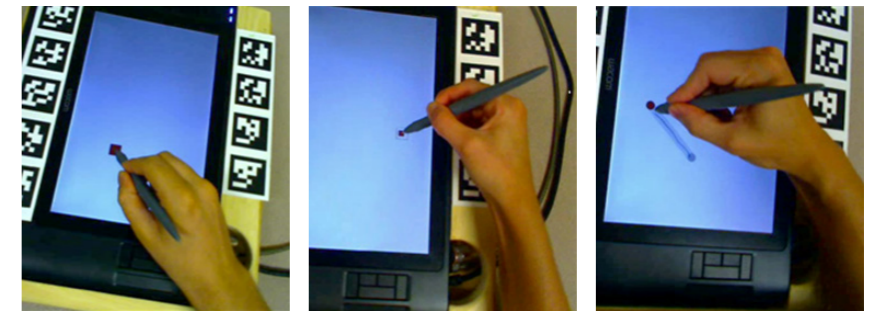
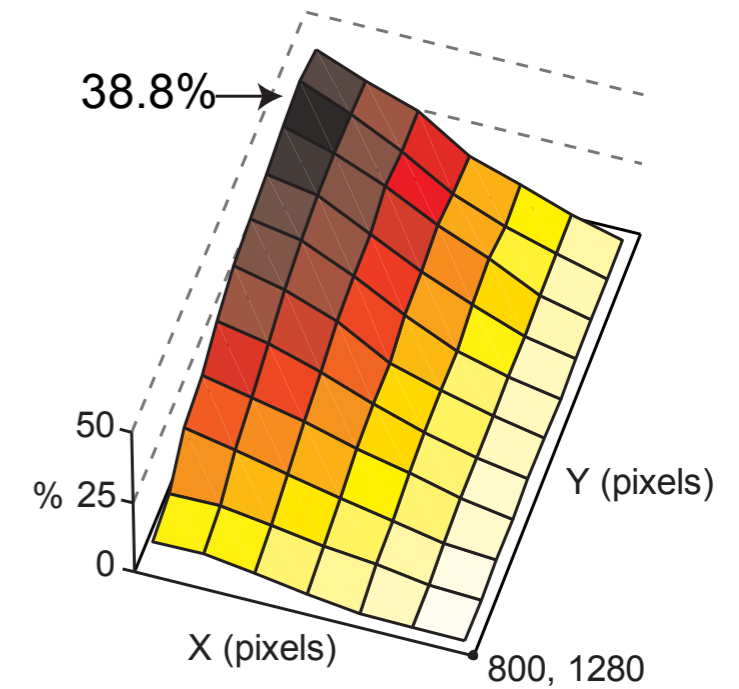

Scalable Circle and Pivoting Rectangle Model

context and task

challenges

Device Support

Gestural Input

Occlusion

input technologies

challenges in interaction design

output technologies

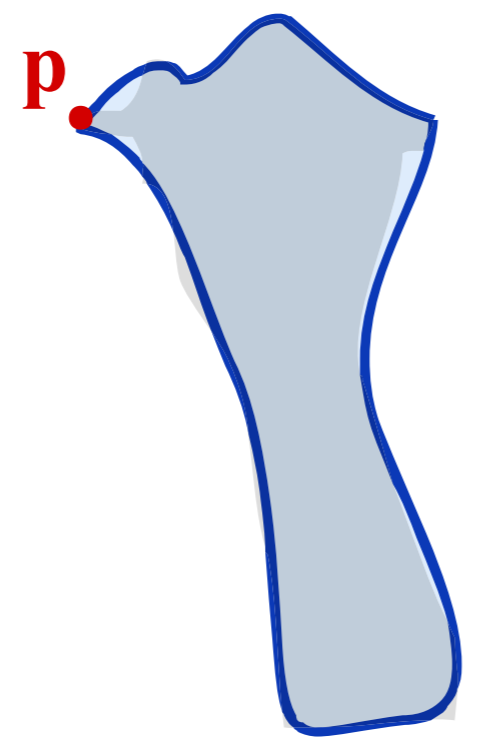

(a)

Bézier spline

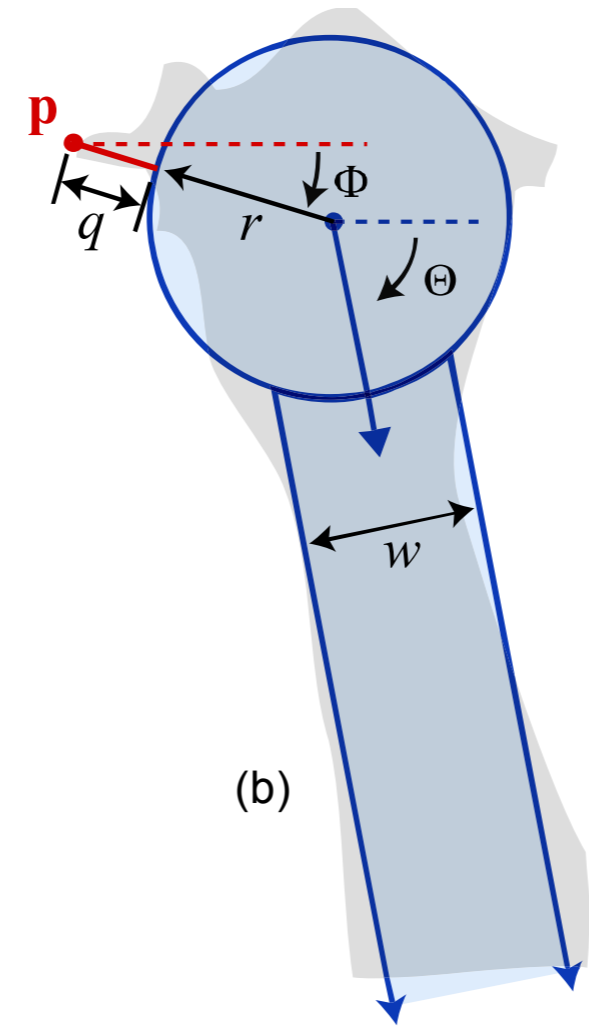

(b)

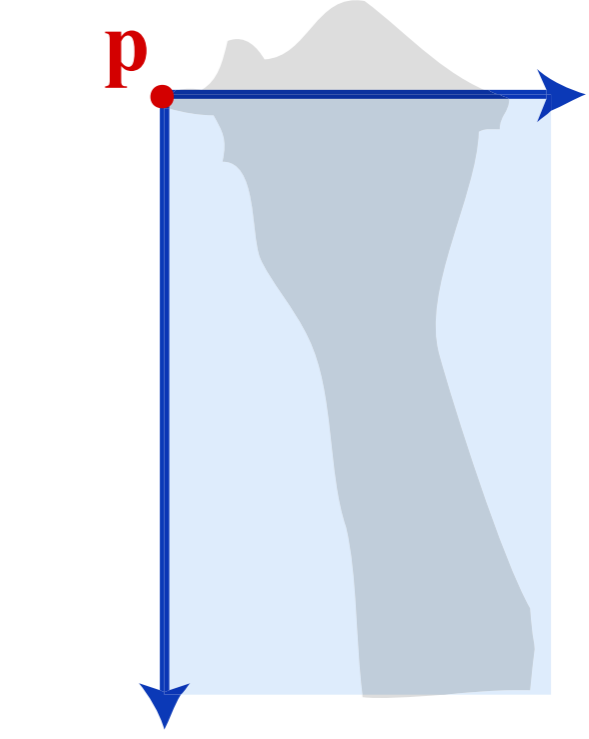

(c)

bounding rectangle model

Literature: Vogel, D. et al. (2009). *Hand Occlusion with Tablet-sized Direct Pen Input*, CHI'09

Scalable Circle and Pivoting Rectangle Model

context and task

challenges

Device Support

Gestural Input

Occlusion

input technologies

challenges in interaction design

output technologies

- 5 parameters:
 - q offset from pen position to circle edge
 - r radius of the circle
 - ϕ rotation angle of circle around p
 - Θ rotation angle of rectangle around the center of the circle
 - w width of rectangular representation of forearm.

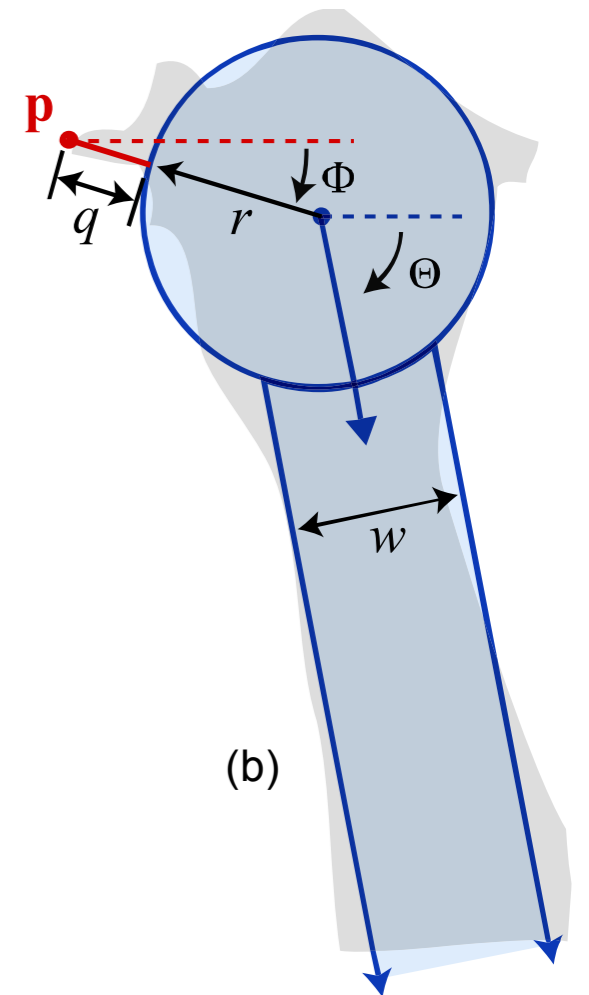
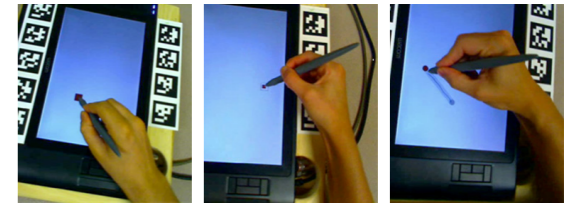

context and
task

challenges

Device
Support

Gestural
Input

Occlusion

input
technologies

challenges in
interaction
design

output
technologies

Occlusion-aware techniques

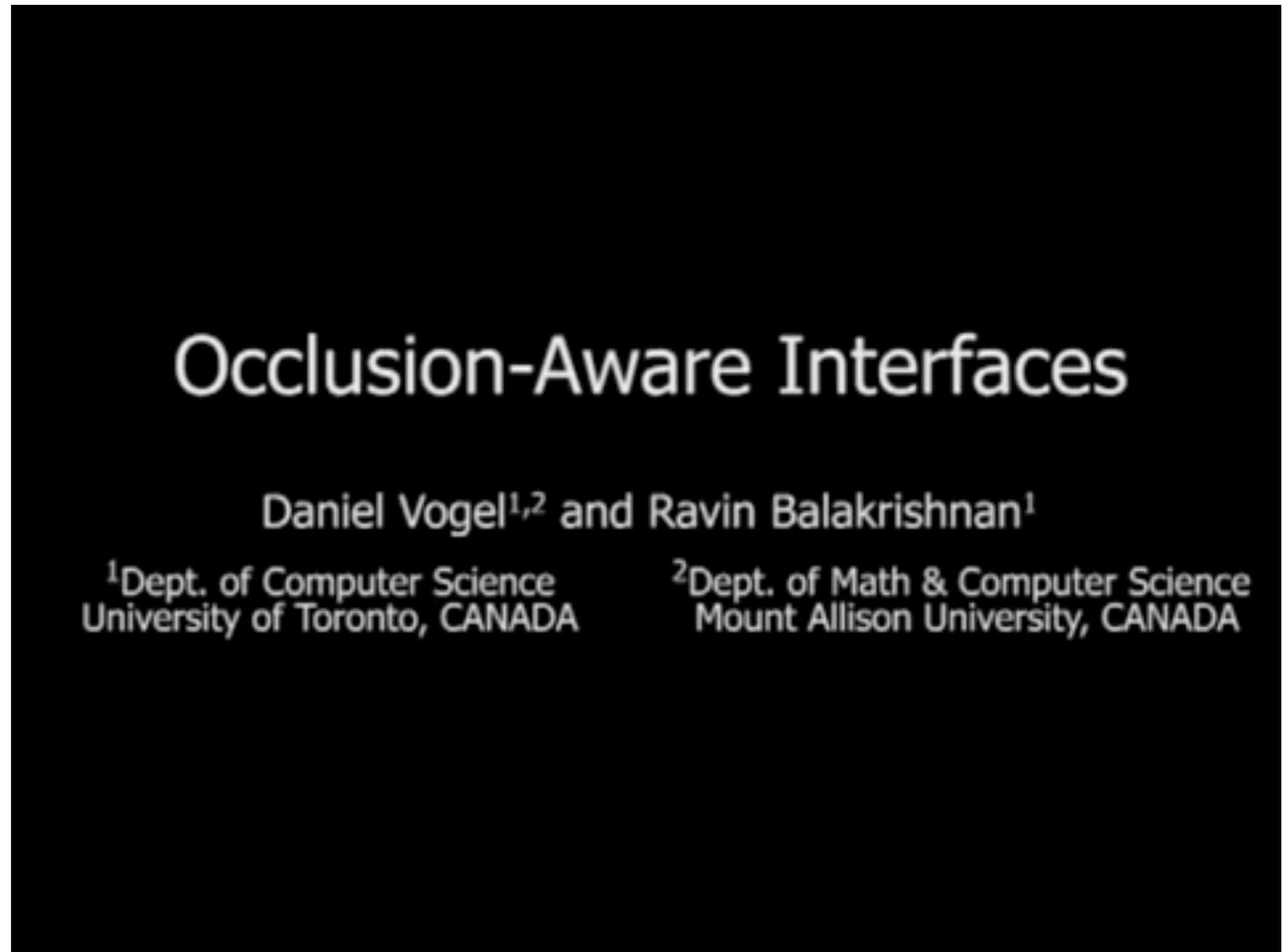

<http://www.youtube.com/watch?v=4sOmlhEJ2ac>

Occlusions and the Fat Finger Problem

- Fingers and hands can occlude screen objects
 - minimize by adapting the screen layout!
- Fingers may hit several small objects
 - just use large objects ;-)
- Exact hit point is occluded, precision limited!
- We'll discuss workarounds in the Interaction part next week

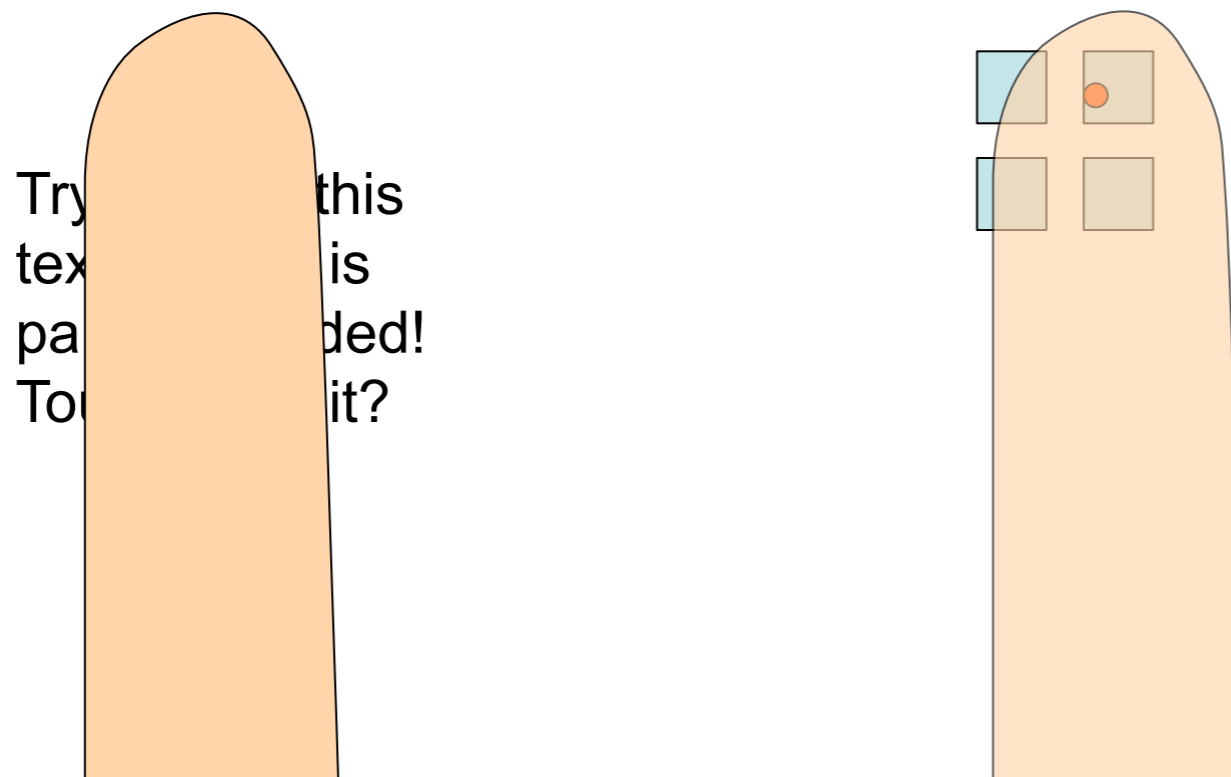

Fat Fingers and FFitts law

context and
task

challenges

Device
Support

Gestural
Input

Occlusion

input
technologies

challenges in
interaction
design

output
technologies

- For small targets and fat fingers, there is a limit to pointing precision!
 - Fitt's law fails to predict performance in this situation
- Modify Fitt's law formula to account for precision
 - think of it like of Newtonian and relativistic physics:
 - at small speeds, both are the same
 - towards the speed of light, they differ

$$T = a + b \log_2 \left(\frac{A}{W} + 1 \right) = a + b \log_2 \left(\frac{A}{\sqrt{2\pi e} \sigma} + 1 \right)$$

$$T = a + b \log_2 \left(\frac{A}{\sqrt{2\pi e (\sigma^2 + \sigma_a^2)}} + 1 \right)$$

Precision

Xiaojun Bi, Yang Li, Shumin Zhai: FFitts Law: Modeling Finger Touch with Fitts' Law, ACM CHI 2013, <http://yangli.org/pdf/ffits.pdf>

context and
task

challenges

input
technologies

challenges in
interaction
design

output
technologies

Take-away message

- Three on-going research challenges with touch and pen input
 - device support
 - gestural input
 - occlusion & fat fingers
- Approaches:
 - analyzing interaction using the kinematic chain
 - apply, extend and test existing theories from other fields (psychology, mathematics, linguistics, physics)
- In particular: the body's spatial relationship affects interaction performance and perceived comfort (was that the case in desktop env.?)

Mobile Technologies

context and task

challenges

input technologies

challenges in interaction
design

output technologies

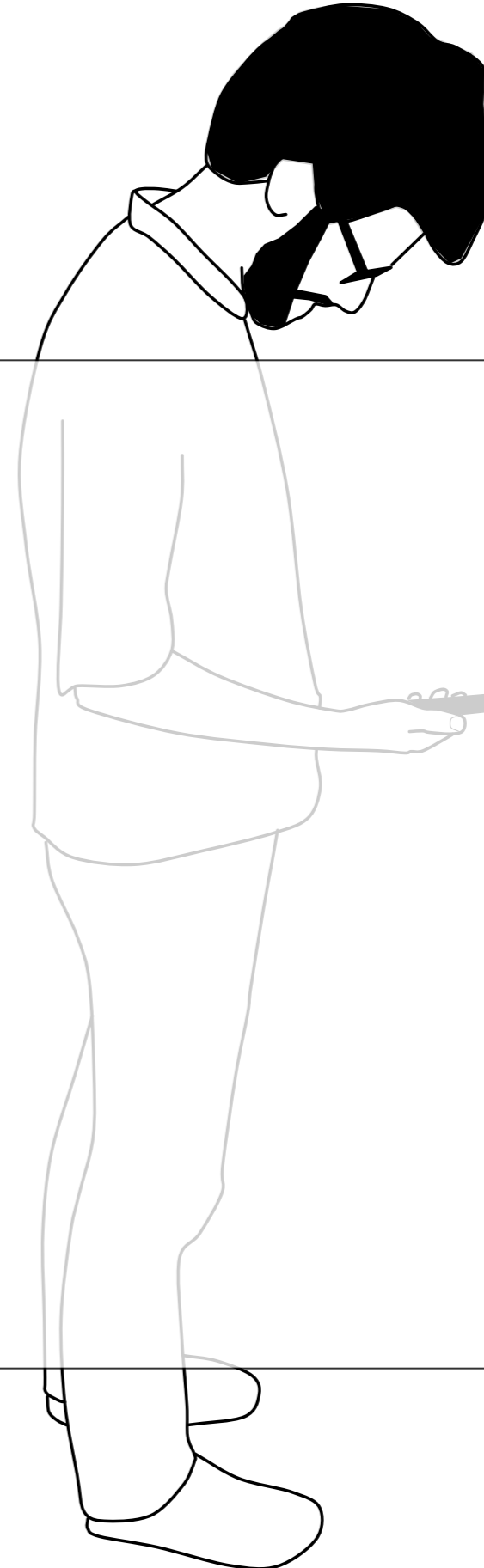

context and
task

challenges

**input
technologies**

challenges in
interaction
design

output
technologies

Touch Input

- Resistive Touch
- Capacitive Touch
- Tangibles on capacitive touch screens

Resistive touch screen

[\[http://de.wikipedia.org/wiki/Touchscreen\]](http://de.wikipedia.org/wiki/Touchscreen)

- Two sheets of conductive, transparent material
- Connected by finger or pen pressure
- Resistance measurements
 - Between X electrodes
 - Between Y electrodes

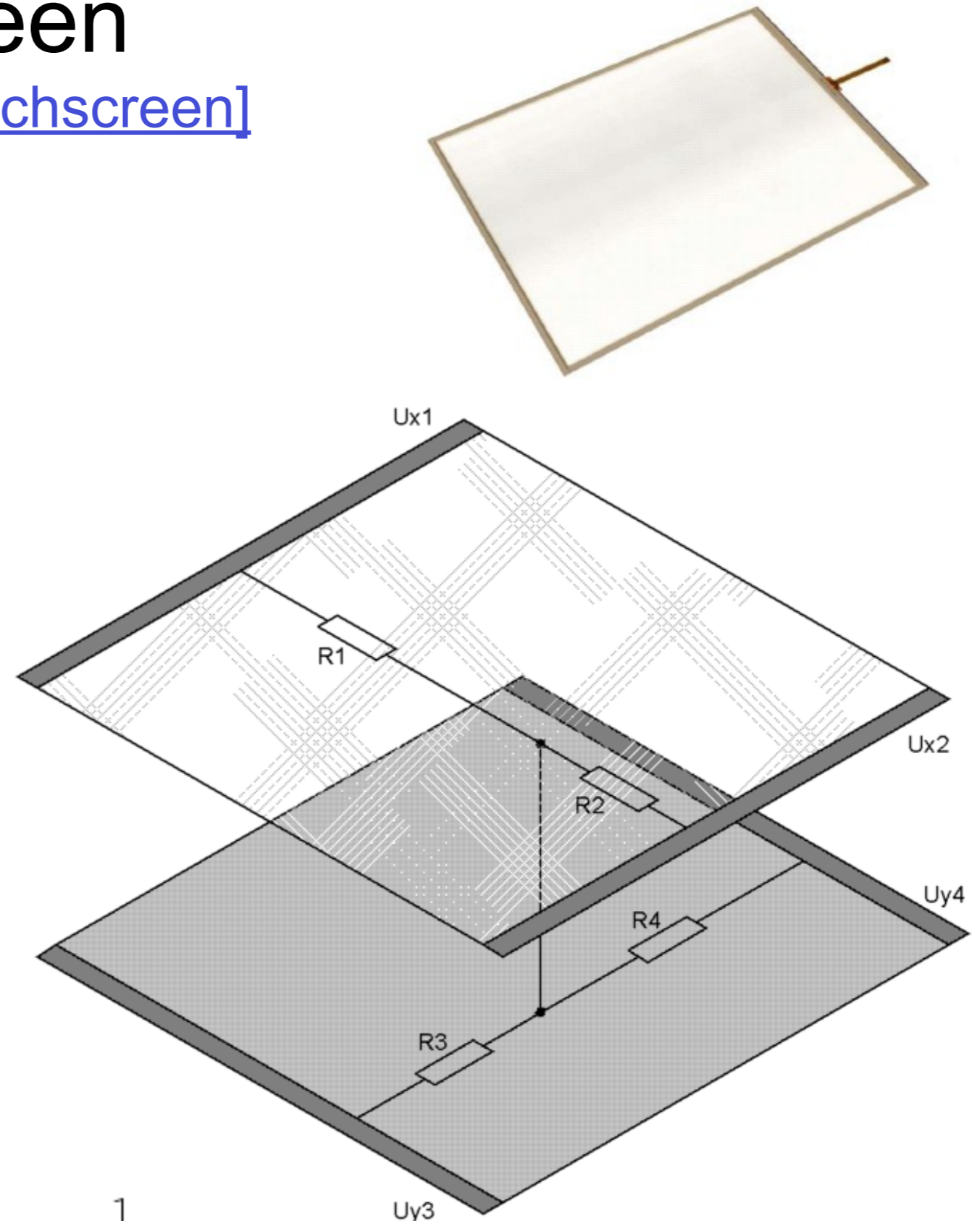

$$U_{y3} = U_{y4} = U_{x2} + \frac{(U_{x1} - U_{x2}) * R_2}{R_1 + R_2} = 0V + 5V * \frac{1}{3} = 1,66V$$

Capacitive Touch: e.g. iPad + iPhone

<http://electronics.howstuffworks.com/iphone2.htm>

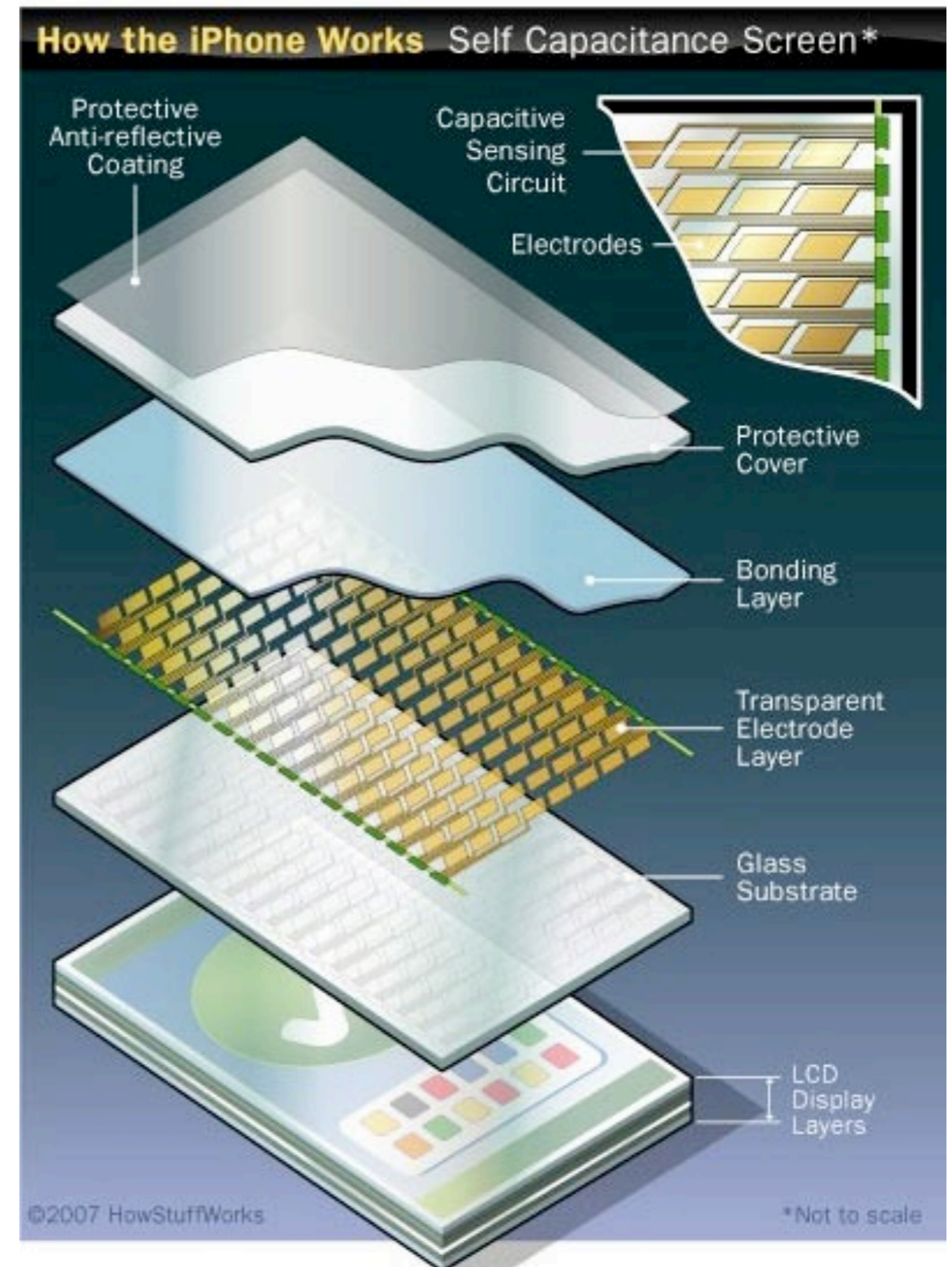
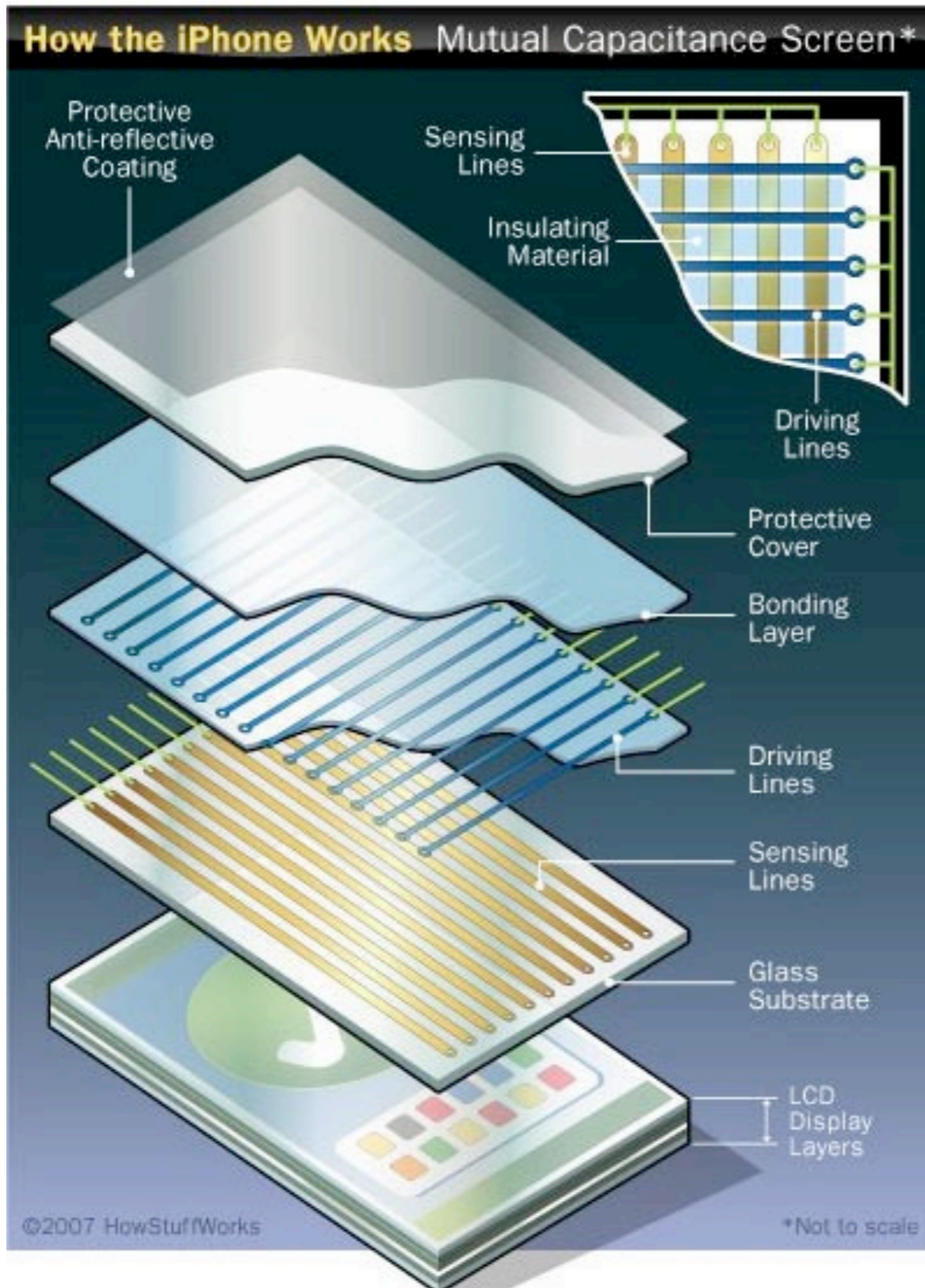

CapWidgets [Kratz et al. CHI 2011]



Sketch-a-TUI [Wiethoff et al. TEI 2012]

- Prototyping approach for TUIs on capacitive touch screens
- Uses conductive ink to transfer touch
- Same principle can be used on all capacitive surfaces

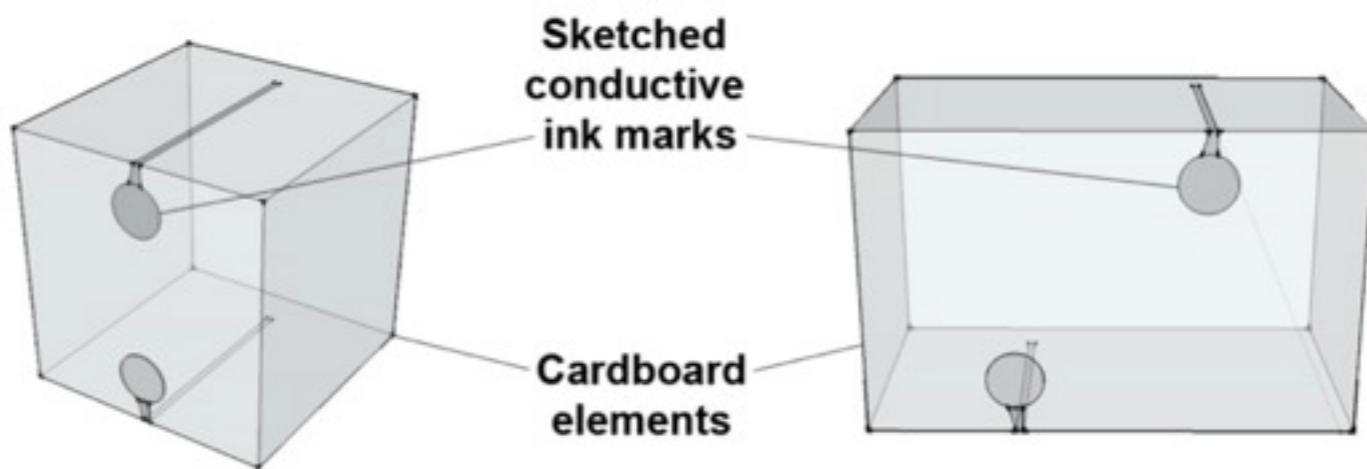

context and
task

challenges

**input
technologies**

challenges in
interaction
design

output
technologies

Sensor-based input

- accelerometers
- magnetometers
- proximity sensors

Sensors in Current Mobile Devices

- Multi-touch display or keypad
- GPS sensor (location)
- Accelerometer (orientation)
- Magnetometer (heading)
- Distance sensor (proximity)
- Ambient light sensor (brightness)
- RFID/NFC readers (tags)
- Camera



Accelerometer



Magnetometer

How do Accelerometers work?

- Measure acceleration
 - Change of velocity
- Causes of acceleration
 - Gravity, vibration, human movement, etc.
- Typically three orthogonal axes
 - Gravity as reference
- Operating principle
 - Conceptually: damped mass on a spring
 - Typically: silicon springs anchor a silicon wafer to controller
 - Movement to signal: Capacitance, induction, piezoelectric etc.
- Derive position by integration
 - Problem: drift

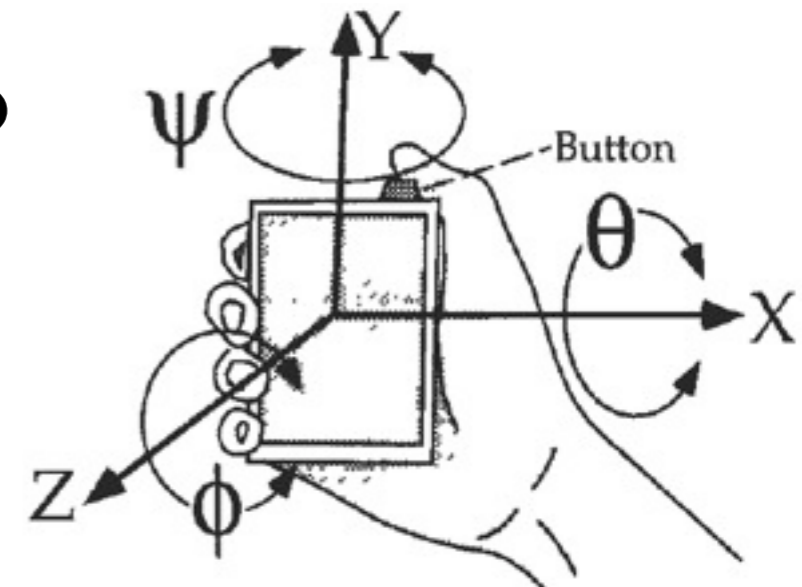

Source: Rekimoto: Tilting Operations for Small Screen Interfaces, 1996

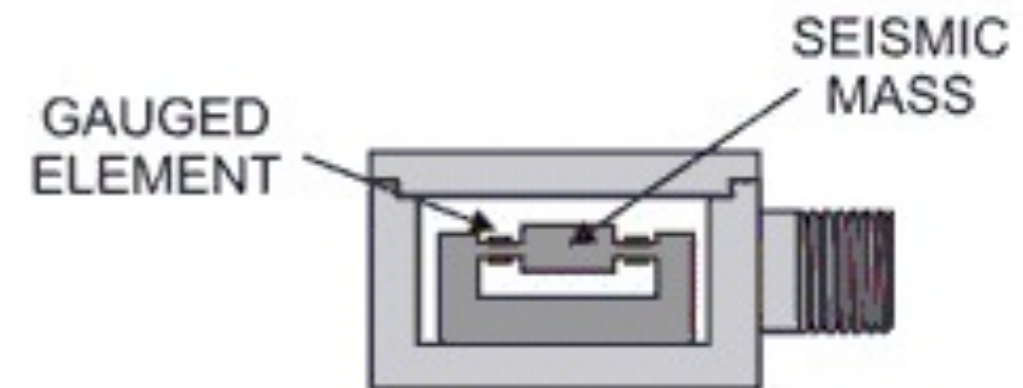

Accelerometer Uses



http://www.youtube.com/watch?v=Wtcys_XFnRA



<http://www.youtube.com/watch?v=Hh2zYfnvt4w>



<http://www.youtube.com/watch?v=KymENgK15ms>

Accelerometers

Health & Fitness: “Sleep Cycle”

- Uses accelerometer to monitor movement during sleep
- Uses motion to find best time to ring alarm (within 30 min window)

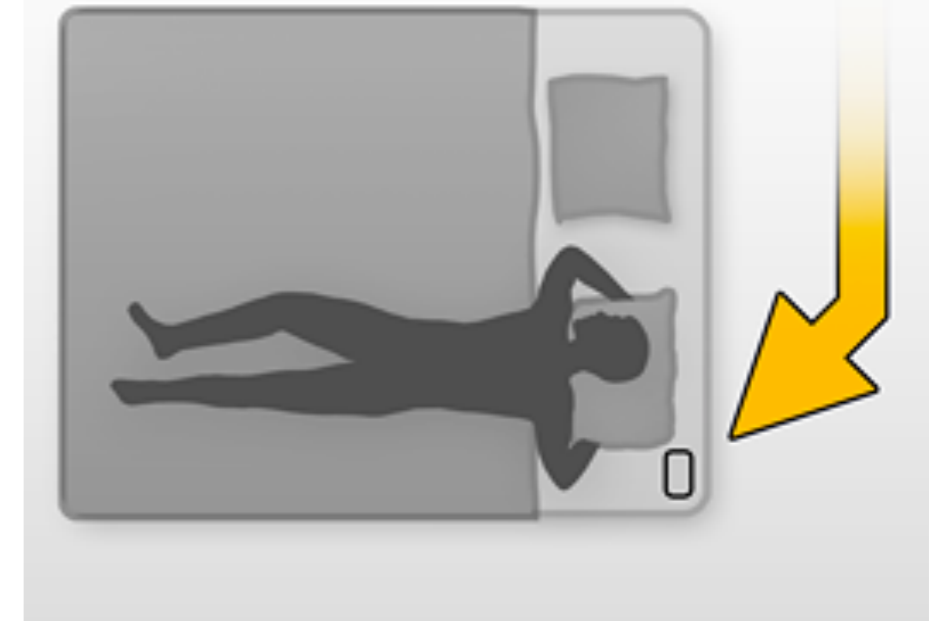

Shoogle: Shaking Mobile Phones Reveals What's Inside

- Accelerometer input
- Sonification
- Vibrotactile display



Figure 2. The wireless SHAKE sensor, shown with a 2 Euro piece for size comparison. This Bluetooth device comprises a complete inertial sensing platform.

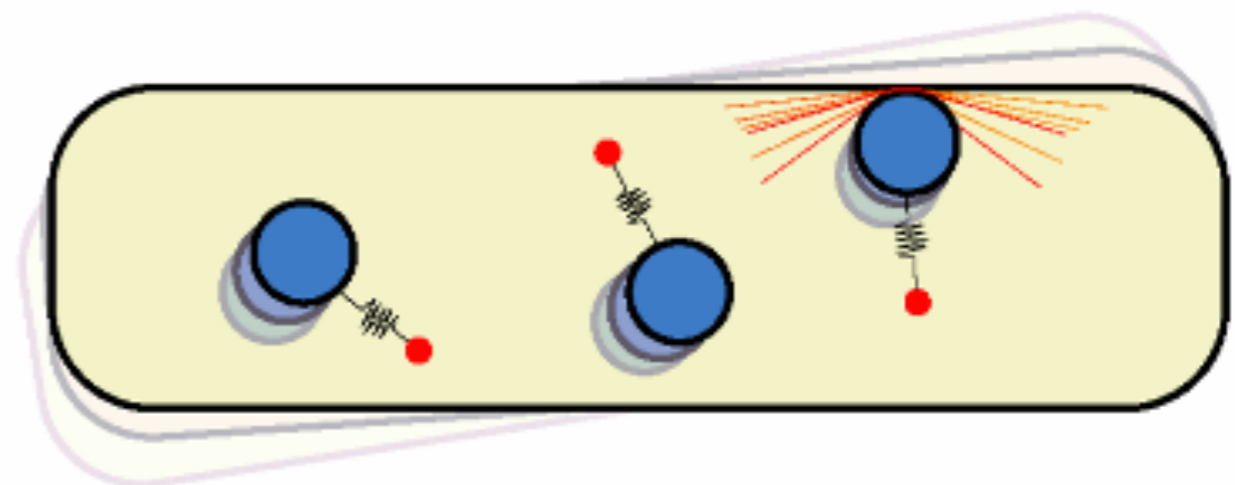

Figure 3. The simulated system. A number of balls, anchored via springs, bounce around within the virtual container. When they impact (as in the top right) sound and vibration are generated.

John Williamson, Dynamics and Interaction Group, Glasgow University

Shoogle: Shaking Mobile Phones Reveals What's Inside

SHAKING CELLPHONES
REVEALS WHAT'S INSIDE

Footage courtesy of
Dynamics and Interaction Group
Glasgow University, UK

http://www.youtube.com/watch?v=AWc-j4Xs5_w

Throw and Tilt: Mapping Gestures to Meaning

- Throw gesture to move content between display types
- Tilt gestures to navigate large display content



Source: Dachsel, Buchholz:
Natural Throw and Tilt Interaction
between Mobile Phones and Distant
Displays. CHI 2009.

How do Magnetometers work?

- Measure strength and direction of magnetic field
 - Have to be calibrated
- Causes of magnetic fields
 - Earth's magnetic field (varies from place to place)
 - Electro magnetic interference (EMI)
- Typically three orthogonal axes
 - Magnetic north as reference
- Operating principle
 - Rotating coil, hall effect, etc.
- Technical parameters
 - Sensitivity to EMI
 - Update rate

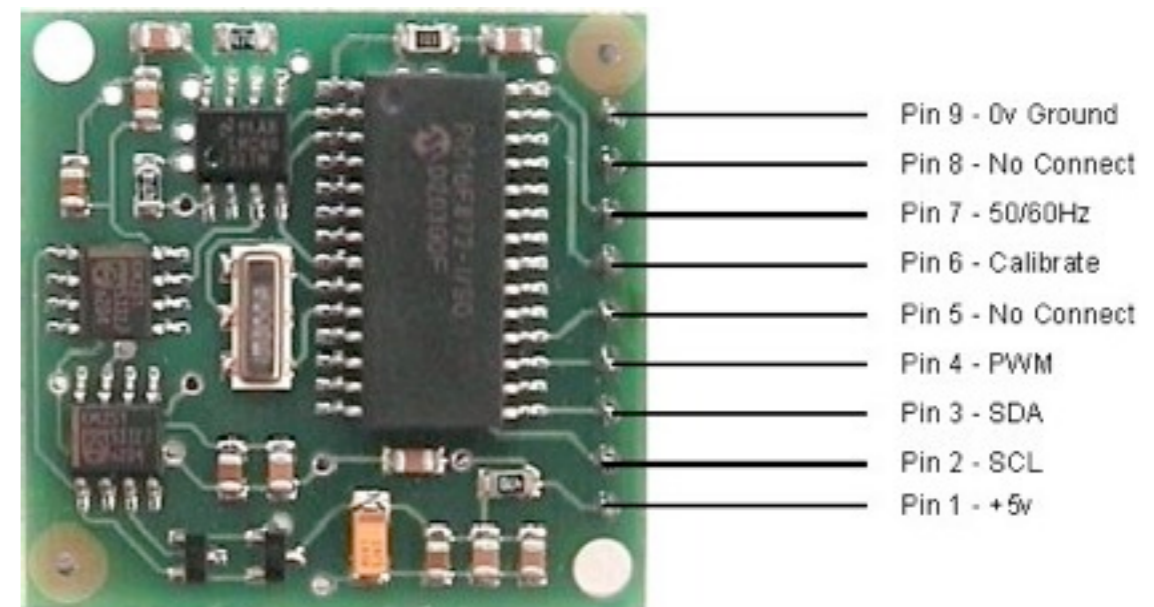

KM51 Magnetic Field Sensor

Using Magnetometers: MagiTact

<http://magitact.com/>

MagiMusic: using embedded compass (magnetic) sensor for touch-less gesture based interaction with digital music instruments in mobile devices, H Ketabdar et al., TEI 2011



Side-of-Device Interaction: SideSight

- Useful if device is placed on table
- Distance sensors along device edges
 - Multipoint interactions
- IR proximity sensors
 - Edge: 10x1 pixel “depth” image

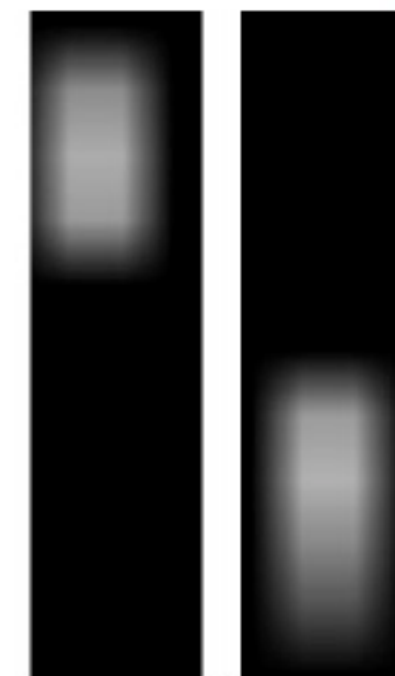
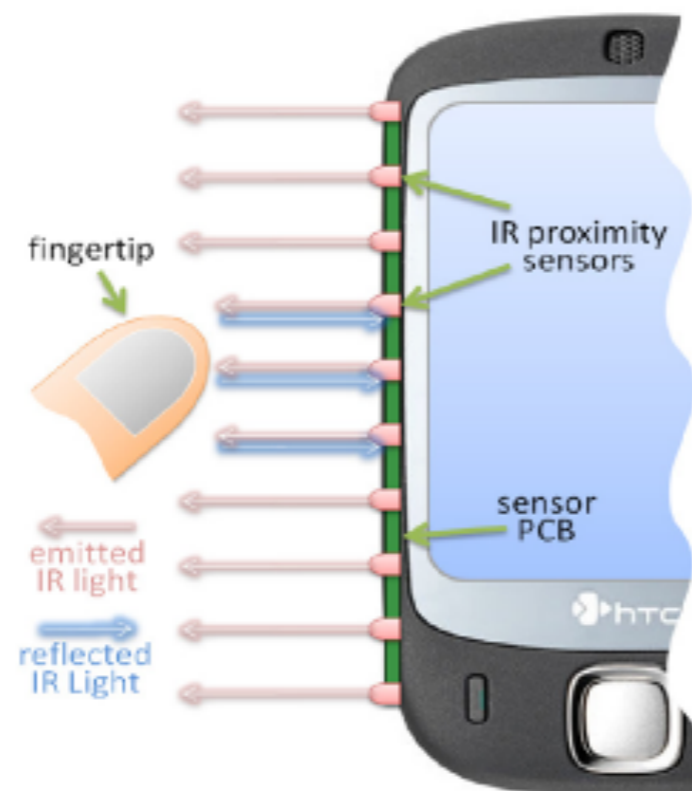

Left and right “depth” images

Butler, Izadi, Hodges. [SideSight: Multi-“touch” Interaction Around Small Devices](#). UIST'08.

Side-of-Device Interaction: SideSight



Butler, Izadi, Hodges. [SideSight: Multi-“touch” Interaction Around Small Devices](#). UIST'08.

context and
task

challenges

**input
technologies**

challenges in
interaction
design

output
technologies

Using further sensors

- shearing: Shear
- bending: Gummi
- bending with flexible displays
- sound propagation: Skinput
- EMG sensors: Myo

Shear (Chris Harrison et al. CHI 2012)

context and task

challenges

input technologies

challenges in interaction design

output technologies



Bending: Gummi (Schwesig, Poupeyrev, 2002)

context and task

challenges

input technologies

challenges in interaction design

output technologies

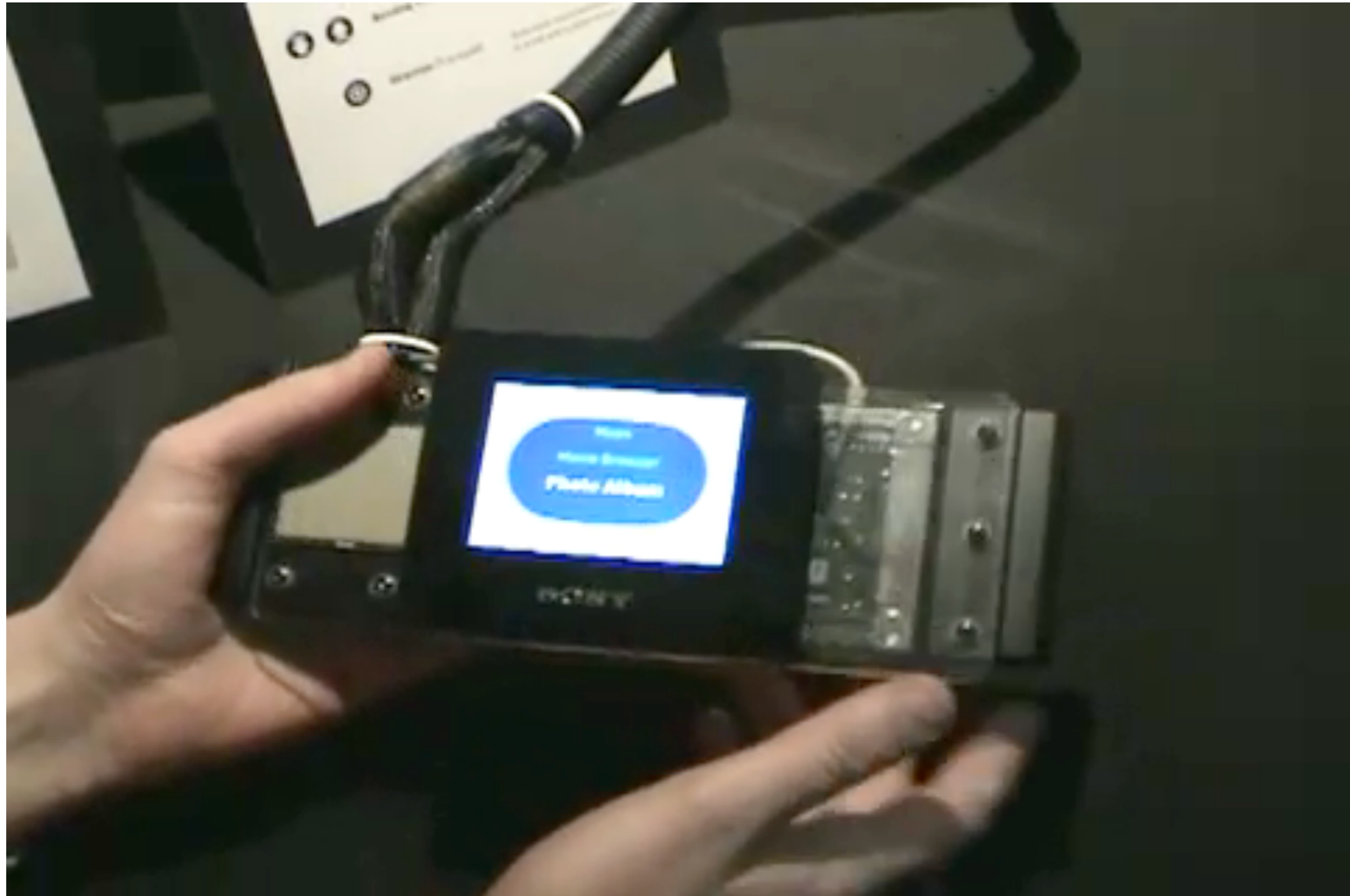

PaperPhone: Bend Gestures in Mobile Devices with Flexible E-Paper Display



Use device as watch...



...detach, use as PDA

Lahey, Girouard, Burleson, Vertegaal. [PaperPhone: Understanding the Use of Bend Gestures in Mobile Devices with Flexible Electronic Paper Display](#). CHI 2011.

PaperPhone: Bend Gestures in Mobile Devices with Flexible E-Paper Display



Lahey, Girouard, Burleson, Vertegaal. [PaperPhone: Understanding the Use of Bend Gestures in Mobile Devices with Flexible Electronic Paper Display](#). CHI 2011.

Skinput

<http://www.chrisharrison.net/index.php/Research/Skinput>

context and
task

challenges

**input
technologies**

challenges in
interaction
design

output
technologies



MYO - muscle input

- <http://www.youtube.com/watch?v=oWu9TFJjHaM>

context and task

challenges

input technologies

challenges in interaction design

output technologies

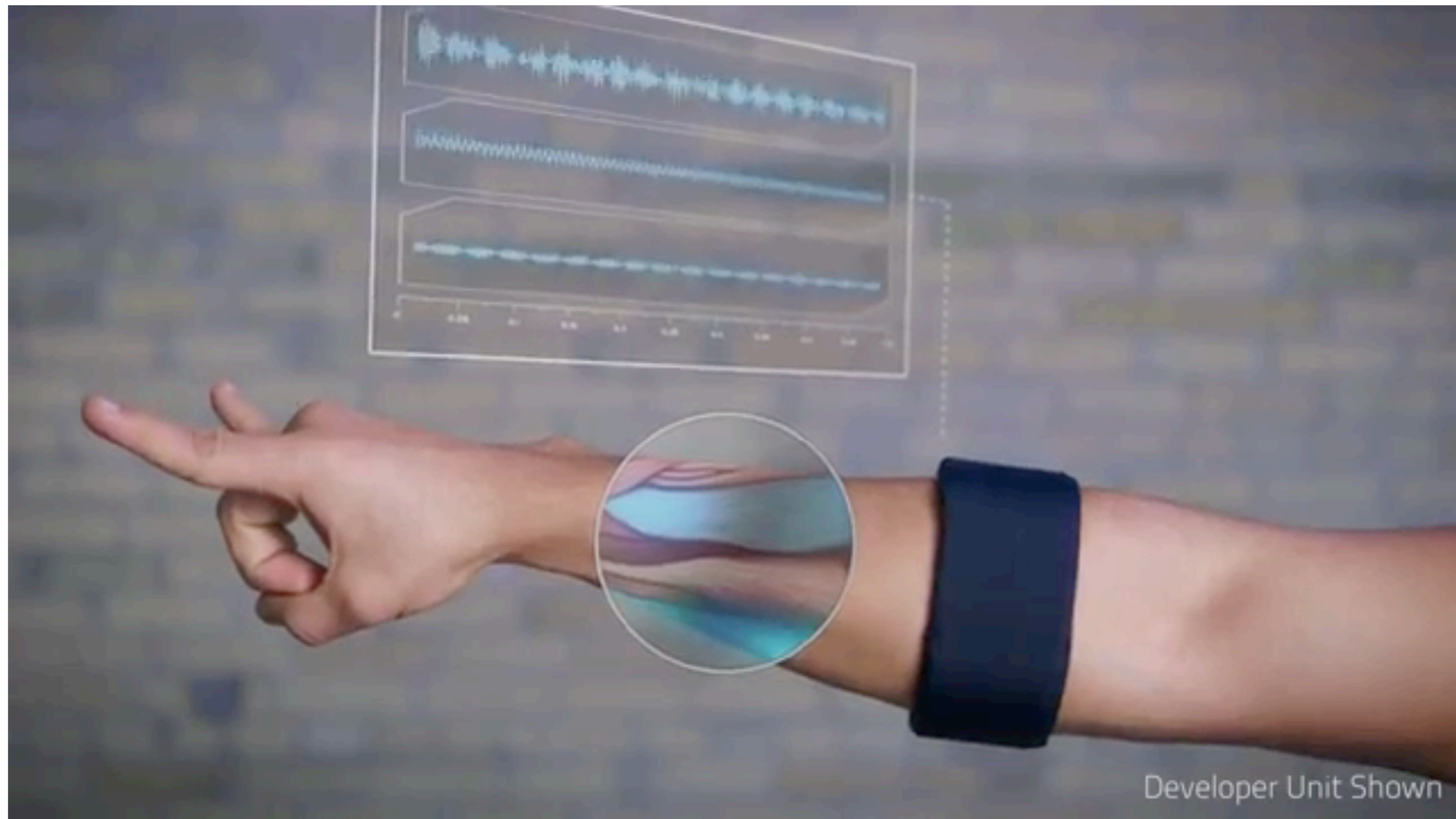

context and
task

challenges

**input
technologies**

challenges in
interaction
design

output
technologies

Take-home Message

- Input on mobile devices can be much more than (touch) screen input
 - think beyond classical GUIs
 - find interactions appropriate to the task
 - add more sensors if needed



OPEN LAB DAY

05.12.13, 18:00 bis 22:00
Amalienstraße 17

www.medien.ifi.lmu.de/openlab