

# StringTouch - From String Instruments towards new Interface Morphologies

Beat Rossmly  
beat.rossmy@ifi.lmu.de  
LMU Munich  
Munich, Germany

Sonja Rümelin  
sonja.ruemelin@ifi.lmu.de  
LMU Munich  
Munich, Germany

Alexander Wiethoff  
alexander.wiethoff@ifi.lmu.de  
LMU Munich  
Munich, Germany

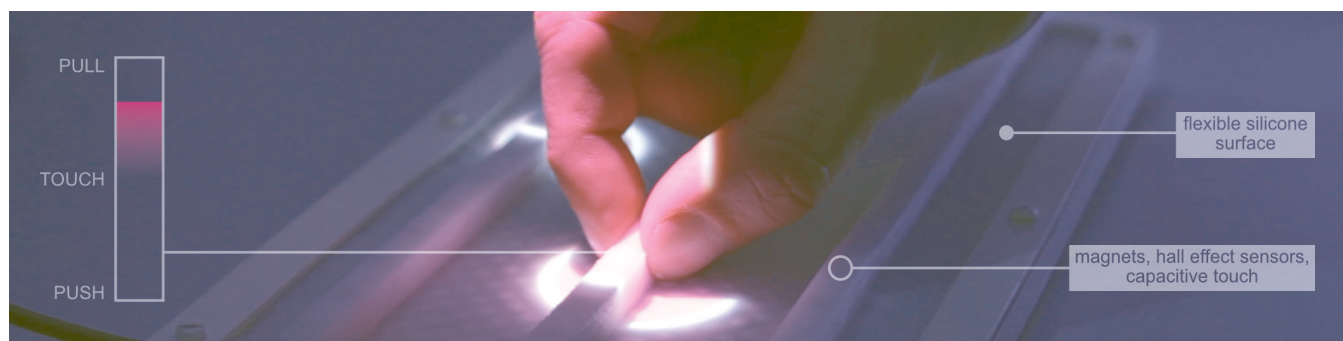

**Figure 1:** StringTouch takes interaction principles that developed over the last thousands of years [47] and across multiple cultural as well as spatial spheres and transfers them to a new interface concept (see Video).

## ABSTRACT

We present StringTouch, a user interface design exploration translating the expressive resource of string instruments to a new interface morphology. StringTouch transfers the string as a tactile element of interaction to the touch surface, resulting in a tactilely experienceable interface. In this paper we discuss our research through design centered approach, which focused on the exploration of musical string instruments and their translation to the UI context. To investigate this specific design space, we analyzed the systematic and handling of string instruments as well as common HCI principles to develop the interaction concept. The resulting experience prototype demonstrates the idea’s potential for haptic UI design and provides insights into the prototyping process. We present: (1) the investigation of string instruments as a resource for TUI design and (2) the transfer to a generic UI context to inform new hybrid interface morphologies that combine features of tangible, touch, and flexible interaction.

## CCS CONCEPTS

• **Human-centered computing** → **User interface design**; *Interaction design theory, concepts and paradigms*.

Permission to make digital or hard copies of all or part of this work for personal or classroom use is granted without fee provided that copies are not made or distributed for profit or commercial advantage and that copies bear this notice and the full citation on the first page. Copyrights for components of this work owned by others than ACM must be honored. Abstracting with credit is permitted. To copy otherwise, or republish, to post on servers or to redistribute to lists, requires prior specific permission and/or a fee. Request permissions from [permissions@acm.org](mailto:permissions@acm.org).

TEI '21, February 14–17, 2021, Salzburg, Austria

© 2021 Association for Computing Machinery.

ACM ISBN 978-1-4503-8213-7/21/02...\$15.00

<https://doi.org/10.1145/3430524.3440628>

## KEYWORDS

TUI; String Instrument Inspired; Interaction Vocabulary.

### ACM Reference Format:

Beat Rossmly, Sonja Rümelin, and Alexander Wiethoff. 2021. StringTouch - From String Instruments towards new Interface Morphologies. In *Fifteenth International Conference on Tangible, Embedded, and Embodied Interaction (TEI '21)*, February 14–17, 2021, Salzburg, Austria. ACM, New York, NY, USA, 10 pages. <https://doi.org/10.1145/3430524.3440628>

## 1 INTRODUCTION

One key principle in current user experience (UX) and user interface (UI) design is to work with familiar mental models and strong metaphors in order to create easy-to-use and understandable interfaces [36]. We propose that musical instruments can provide several benefits in this context and position themselves as resources to inspire new interaction principles and interface concepts. The playing of instruments has long been a cross-cultural tradition, ensuring that even those who don’t play themselves are, through observation of others, familiar with common operation principles such as, for example, *strumming and picking*. Furthermore, playing instruments hardly requires any visual attention for experienced musicians and, in this respect, could be superior to the operation of touch interfaces which can be overwhelming in different contexts [51]. However, their interaction vocabulary has so far remained mainly unconsidered in HCI and therefore represents an unused resource for interface design.

We have taken a reference in the interaction principles of playing string instruments and investigated the translation of the physical motions and the instruments’ morphology to current UI design research. Reflecting on our recent work [46] in this domain, we

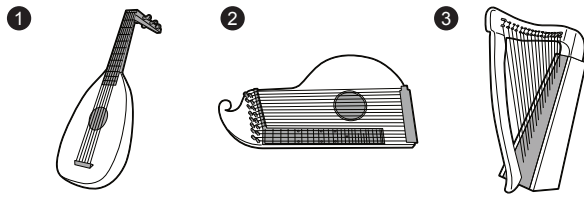

Figure 2: ❶ Lutes, ❷ zithers and ❸ harps differ in the string-orientation towards the corpus and the neck/body separation. This influences the body posture during interaction.

present the analysis of string instruments and their interaction techniques, an initial exploration transferring the interaction concept to a prototype and the technical details of our implementation. In summary we aim to incorporate strong familiar interaction concepts to contemporary UI research. We take into account Tangible User Interface (TUI) principles and flexible materials for design context appropriate UIs which extend the flat surfaces of touch screens into hybrid interfaces.

The key contributions of this work are twofold. (1) We explore the rich and expressive resource of string instruments and (2) transfer it to a generic UI context over two design iterations and inform a new hybrid interface morphology that combines features of tangible, touch, and flexible interaction.

## 2 RELATED WORK

In the following section we consider concepts that are based on users' prior knowledge and interfaces that deal with flexible interaction surfaces, and present approaches of measuring surface deformation in TUIs.

### 2.1 Interaction Based on Users' Prior Knowledge

New interfaces and interaction concepts require from the user to “learn a new set of skills to interact with such technologies” [52]. The question arises whether interactions can be designed in such a manner that allows users to draw from past experiences. Research projects in the context of Shape Changing Interfaces (SCI) and non-rigid interfaces [6] explored familiar interactions with everyday materials such as cloths and fabrics [7] to interact with digital information, by moving, folding, stretching, and pushing the material. Other flexible materials such as wires [49] and ropes [61] have been used to define known interactions such as kinking a power cord to turn on/off a device (blocking the water in a water hose), or to pull on a rope to stop an action (child play or horse riding). Cords, wires, and strings are common in musical instruments and were used in public settings [38], performative contexts [54] or attached to performers [57]. We want to emphasize that these UIs were meant to generate music and not to transfer the string, as a musical interface, to a non musical design context. Most interfaces in context of musical interaction instead focus on the augmentation of the instrument for practice [32, 60] or their improvement with new sensor technologies [19, 34]. Only few references reuse instrument-inspired interaction principles in a generic context. *PianoText* by

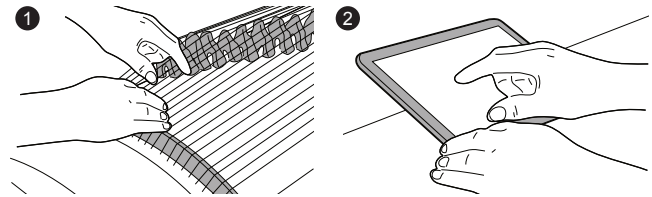

Figure 3: We find similar motion patterns as well as spatial setups during the interaction with ❶ zithers and ❷ touch-based user interfaces.

Feit et al. [12], for example, translated a key press into the typing of a character and chords into the writing of whole words.

### 2.2 Flexible Screens and Interaction Surfaces

Touch screens have become ubiquitous today, because they make a variety of information and functions available with just one technology component. However, one drawback is the lack of physical experiences between flexible content and the solid nature of the touch-surface. To make the tactile impression of such interfaces more expressive, screens have been turned into flexible surfaces, providing rich ways of interaction. The tabletop systems *Depth-Touch* and *TableHop* [48] drew both from experiences with cloth and supported a spatial data exploration: users were able to manipulate and filter data in multiple depth layers by *pushing*. On a larger scale, users interact with *FlexiWall* [35], a room-sized elastic display that exemplified large data sets, by pushing, pulling or bending.

### 2.3 Measuring Surface Deformation

Large scaled flexible interfaces often use optical sensors to track deformation. While commercially available depth cameras can be used [35], this is associated with spatial requirements (table to room size). Other approaches to measure the deformation of surfaces or objects include properties such as photorefectivity based on the translucency changes of compressed fibers [53], resistance changes of conductive padding [56], and air pressure [13]. These interfaces are rather limited in sensor density and make heavy use of interpolation. Rigid surfaces can be augmented with magnets and hall effect sensors. Thus, e.g. physical elements on touch displays can be tracked to create interactions beyond touch [31].

Flexibility and deformability are especially relevant in Organic User Interfaces [23] and SCI [14, 44, 62] because of their need for flexible and morphable materials [43]. Soft and easy-to-process materials such as silicones are therefore used to merge technology directly with the interaction materials [55]. To control the deformation of silicone elements air pressure [62], or ferrous silicone structures responding to electromagnetic fields [15, 63] can be used. In the same way, magnetic materials can be embedded in silicone surfaces to create tactile feedback [9, 28] or to track deformation and interaction [17]. Even complex interactions can be tracked by hall effect sensors such as bending or twisting [50]. New sensor technologies based on magnetism and structure displacement [11] are used to measure touch and pressure in flexible skin-worn UI combined with capacitive sensing and resistive materials [59].

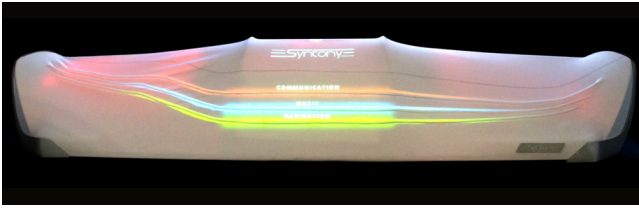

**Figure 4: Three string-like pleats span over the dashboard-like interface so that driver and co-driver can both interact with the system. The colors represent the three sub-menus: communication, music, navigation.**

## 2.4 Implications for the Design of Instrument-Inspired Morphologies

As discussed above, tangible interfaces can provide familiar interaction principles building on the prior knowledge of users, which make their operation principles easy to discover, understand and replicate. Further by providing a physical structure, users can grasp, operate, and explore the interface using all their senses. In contrast, touch interfaces strongly rely on the users visual attention and provide limited way of interaction. Here, flexible UIs can expand on touch interaction providing additional interactions that are strongly connected to the usage principles of common materials such as fabrics. However, well-known interfaces such as string-instruments still remain unconsidered in recent HCI research outside the musical domain. To fill this gap with user experience prototype based learnings we have methodologically investigated their basic operation principles and started their exploration in the form of generic UI concepts. In the following sections we share the process and insights based on our research through design exploration.

## 3 TRANSFER OF INSTRUMENTS TO INTERFACES

Looking into string instruments, we argue that some of these provide similar operation setups to touch screen interaction (see Fig. 3). With the similar setup in mind, similar challenges can occur. Our hypothesis is that these challenges could be addressed with insights inspired by the design of and interaction with string instruments.

**Challenges of today's screen-focused interaction** are twofold. First, the interaction is applied only towards the UI and is treated in a binary manner. Second, most interactions depend on the visual contact with the UI and thus are not blindly applicable. This is contrary to decades of UI design where the *tactile experience* of dedicated physical elements and the trained motor memory [24, 29] enabled blind operation. While this sounds marginal, the implementation of screens in critical contexts such as driving, where visual attention is an important good, has just begun. Touch screens that replace interfaces in the car interior force the user to focus on the UI and not on their surrounding [2].

**A source for new design concepts** could be instruments, as they overcome similar challenges. During learning, students are confronted with two simultaneous tasks: Following along with the music on the sheet and operating the instrument. With practice, their focus remains on the sheet and hand movements are executed

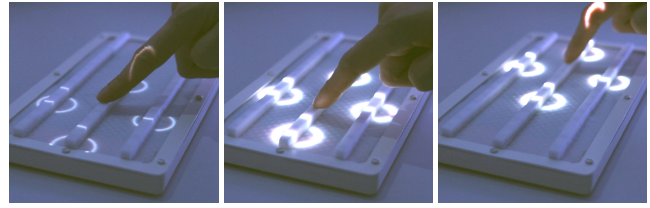

**Figure 5: The second prototype resembles a generic USB peripheral such as a keyboard. This opens up new contexts for exploring the interaction. UI elements appear around and follow the hand, similar to pie menus [8].**

blindly due to the motor memory, the instrument's structure and the tactile orientation. Since, instruments offer expressive, continuous and consistent ways of interaction, we consider them a rich resource for TUIs providing beneficial interaction principles and profound interface morphologies.

**Transfer to new interaction concepts.** With instruments as a conceptual basis, we followed a structured process to analyze the designs and interactions to develop an initial transfer to the UI domain of HCI research. While this work focuses on string instruments, the same process is applicable to other instrument types as well. Carrying out the design process of creating prototypes we followed three basic steps: *Understanding* basic design variations of the instrument type and the implications for the user interaction. *Investigating* interaction techniques as a basis for potential interactions. *Deriving* semantic matches to inform consistent and meaningful motion patterns.

### 3.1 Understanding String Instrument Designs

Following the systematic of Hornbostel-Sachs [58], string instruments are divided into three groups (see Fig. 2). Yet, the actuation of strings does not influence this categorization: **(1) Lutes** consist of a body and a separated neck (cf. guitar), their strings run in parallel to both, and they are mostly held pointing towards the audience. **(2) Harps'** strings run perpendicular to the body (resonator), they offer multiple strings which cover a whole scale, since their strings can not be fretted without a neck. Harps are hand-held or free standing and are played with one or two hands. **(3) Zithers'** strings run in parallel to the resonator, no separation of neck and body is made. Either the body itself functions as the fingerboard or objects are used to fret the strings. Zithers are placed on the lap or in front of the musician.

Zithers present a promising design resource, since their spatial operation context is close to touch screen interaction and special forms (Guqin, Guzheng) use a more generous string spacing, are operated bare fingers [16], and offer playing techniques (Yin) which shows high commonality with perpendicular interactions (push/pull) used on flexible screens.

### 3.2 Investigating String Instrument Interaction Techniques

A detailed collection of string instrument interactions are presented in Figure 6, the most basic interactions are:

## TECHNOLOGY & INTERACTION – DIMENSIONS

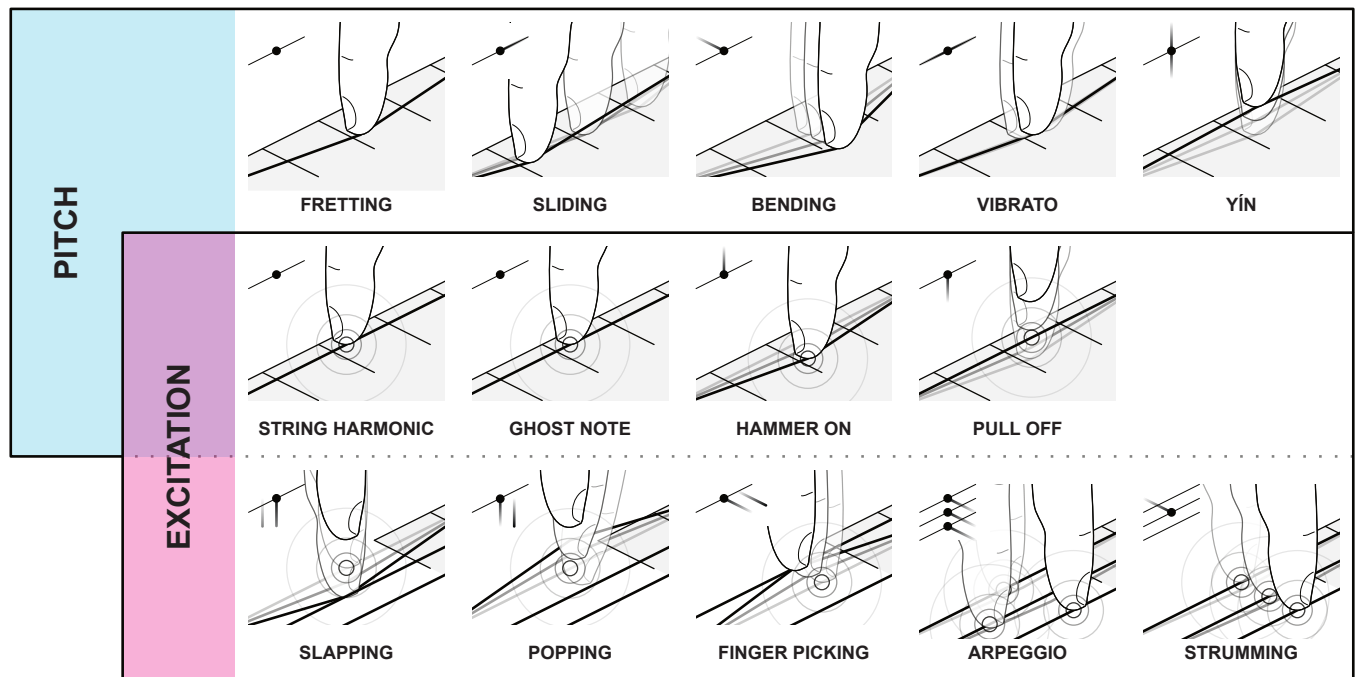
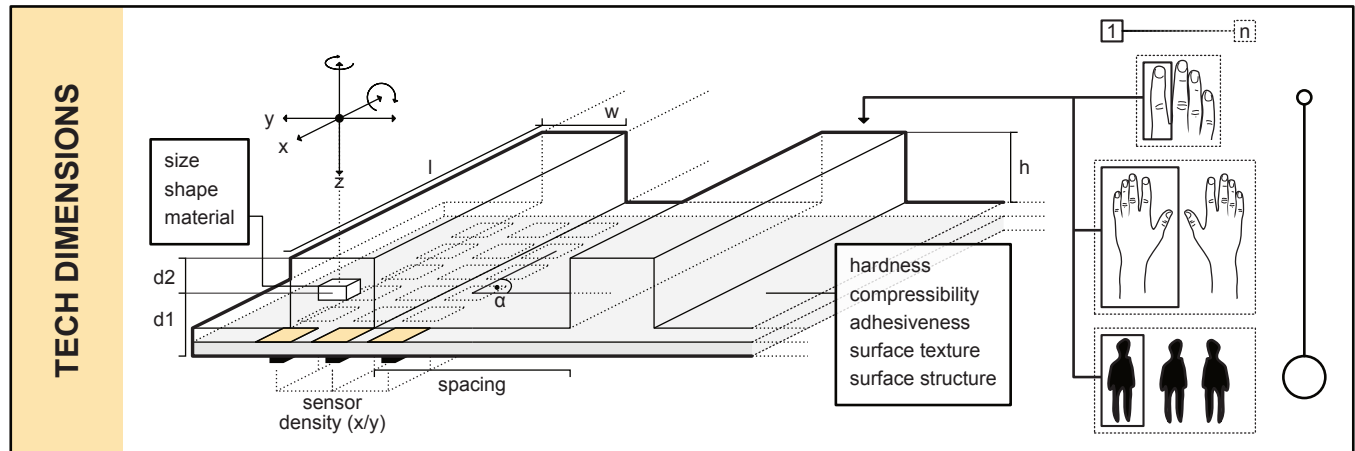

<b>Fretting</b>	Pressing strings against fingerboard. Increases pitch.
<b>Sliding</b>	Moving pressed finger along string. Moves between pitches.
<b>Bending</b>	Moving string vertically to string. Increases pitch.
<b>Vibrato</b>	Wiggling pressed finger along string. In-/decreases pitch.
<b>Yin</b>	Pushing/pulling string vertically to body. In-/decreases pitch.
<b>Flageolet</b>	Touching string on specific fractions. Excites overtones.
<b>Ghost Note</b>	Placing finger on top of string. Creates percussive sounds.
<b>Hammer On</b>	Hitting a string quickly next to a fret. Excites struck string.
<b>Pull Off</b>	Quickly release fretted string. Excites open string.
<b>Slapping</b>	Thumb hitting string over fingerboard. Excites string.
<b>Popping</b>	Snapping back pulled string. Excites string.
<b>Finger Picking</b>	Plucking string. Excites string.
<b>Arpeggio</b>	Finger Picking several strings in specific order.
<b>Strumming</b>	Hitting several strings with hand stroke. Excites strings.

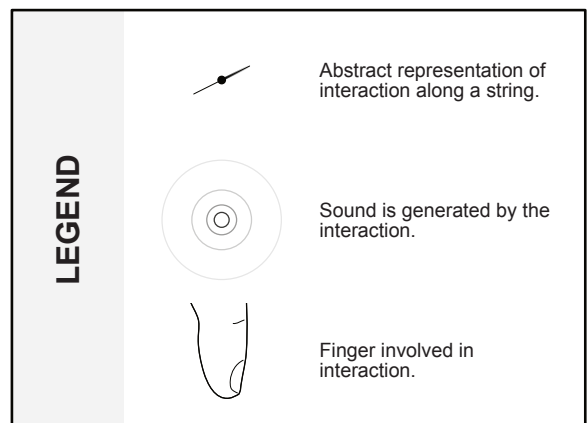

Figure 6: The upper part describes the technical dimensions available for designing interfaces inspired by stringed instruments. The middle part shows the interaction patterns collected from various stringed instruments that form the basis for interactions on StringTouch. The bottom part provides more information about the collected interaction patterns.

**Fretting:** Pressing a string against a fret or the fingerboard. Shortened length of the string increases the pitch.

**Sliding:** Moving the pressed finger from one fret to another on a string. Movement between two far apart pitches.

**Bending:** Moving the pressed finger perpendicular to the string along the fingerboard. Slightly increasing the pitch.

**Finger Picking:** Quickly moving the finger lying on one towards the next string. Snapping back excites the string.

**Muting:** Placing the hand on the resonating strings stops them.

These interactions contain an internal logic based on our prior knowledge about the physical world. *Finger Picking* is based on the experience that potential energy transforms into kinetic energy resulting in oscillation (pendulum, ball). Energy can be removed again by applying a resisting force. *Muting*, in that sense, removes energy from a system.

### 3.3 Deriving Semantic Matches

Derived from the related work and the analysis of string instruments we considered meaningful matches between string-instrument-inspired interactions and actions that are performed on generic UIs, such as 1) selecting, 2) closing, 3) dragging something or 4) adjusting values. Therefore we propose the following mapping:

*Fretting* is a basic selection interaction, choosing a single value out of a set of values, whereas *sliding* is suitable for range selections (from A to Z). *Muting*, known to remove energy, translates to **ESC** for ending or exiting ongoing processes. Pushing/Pulling (*Yin*) makes dragging tangible, an item can be picked (pull) and then be placed (push) at another position. The continuous action of *bending* affords to do adjustments. Bending, as a two-stepped process, transfers into a coarse plus fine tuning action: selecting a specific value (integer), then fine adjust from there (float).

## 4 STRINGTOUCH - DEVELOPING A STRING INSTRUMENT INSPIRED MORPHOLOGY

StringTouch explores the morphology, the metaphor, and the affordances [27] of string instruments and transfers them into a non musical interface context. The idea is to benefit from the qualities of instruments such as the operation without visual attention and their expressive properties. As discussed above string instruments share challenges and interactions with touch devices and flexible interfaces. Hence, we developed an interface concept using string like interaction elements in the context of a flexible touch surface (see Fig. 4 & 5). The motivation and goals are: (1) providing a physical interface structure users can grasp by using string-like elements on a touch surface, (2) expanding on touch interaction principles by taking into account interactions found in both flexible interfaces and string instruments, and (3) applying relative motion patterns as used in pie menus [8] which are similar to the recurring patterns on a instrument fret board. We have developed two completed iterations of the interface concept and share the implementation details and insights of the prototyping process based on our research through design approach [64].

### 4.1 First Generation Prototype

The first design iteration used three rubber tubes that were sewed into the fabric surface of a car dashboard (see Fig. 4) and thus formed

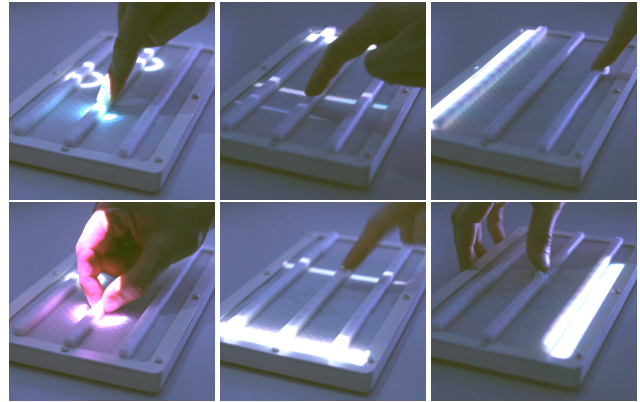

**Figure 7: StringTouch offers the following interactions: push/pull (l.), swipe left/right (m.), strum down/up (r.). Feedback is designed with high-contrast to enable interaction with little visual attention.**

string-like pleats to give users a physical structure to grasp at. The idea was that both, driver and co-driver, could operate the interface via the pleats in front of them, having a menu popping up around the initial contact point, such as known from pie menus, so that there is no need to reach far over the dashboard. While the pleats spanned over the whole surface, only a small area was interactive. A 3x3 button matrix under the surface emulated the intended experience and the UI was projected onto the surface. Users interacted with a multimedia and navigation system using simple gestures such as pushing, pulling, strumming, and muting to take calls, operate the menu, switching music tracks, or controlling the volume. All tasks formed motion patterns composed of small actions (*start* from home, *move to* and *select* sub-menu, *move to* and *interact* with a certain UI element) that resembled gestures which could be implicitly learned. This is also an allusion to playing instruments in which melodies consist of individual actions and can be moved on the fingerboard while retaining their melodic structure. This was designed to be performed blindly after some training to free visual attention for the driving task. Following a user-centered design approach [1] we consider this first exploration as an important step to inform the next experience prototype iteration.

**First Initial Insights:** To collect insights and feedback, we conducted an informal user test. We observed UX behavior patterns regarding the interaction with the prototype during an interdisciplinary workshop (30 master students, 4 lecturers; 20-60 years). The participants operated the interface and performed the previously described tasks. They expressed positive feedback after interacting with the prototype, which invited for playful exploration and made it possible to replicate the given tasks at the first try. The concept was perceived as simple and intuitive to operate along with a level of playfulness which raised curiosity-filled discussions afterwards. Despite this being a first informal observation, we received overall positive feedback on this prototype exploration. This informal setting pointed out aspects of the interface to be improved in the next iteration: The limited sensor resolution, the binary interaction on each sensor (push/pull) and the narrow use case.

## 4.2 Second Generation Prototype

The goals of the second gen. prototype were to increase (1) the sensor resolution and (2) the sensor density along the interface surface. To achieve this we further developed our interface technology and used (1) linear hall effect sensors instead of mechanical buttons and (2) pushed the resolution from 3x3 to 16x3 covering the whole surface. Using silicone for the interface, enabled us to directly integrate the surface design into the interaction material, without the use of additional extensions such as previously used. Hence, the flexible layer became the main point of interaction.

**Sensors:** We used magnets enclosed in silicone and hall effect sensors to continuously track deformation along the surface. Since the deformation of the silicone moves the enclosed magnets in relation to the sensors, the magnetic field is measurably varied. To measure gentle touches in addition to deformation, we added capacitive areas to the sensor PCB (see Fig. 9). The modular design (see Fig. 8 ④) allowed to daisy chain PCBs to construct interfaces of any length. We evaluated the constraints with a systematic stress test focusing on the resolution of the sensor unit. Via a lever, force was applied to the silicone ridge over a metal pin ( $d=2.4\text{cm}$ ) in 8mm distance to the sensor. The force was increased up to 29.42 N in 0.98 N increments and the sensor readings ranged from 1.1V to 1.22V. During pulling the applied force is divided among a perpendicular and parallel motion caused by pinching the ridge. As a benchmark, we measured 1V as the minimum reading (-4.9 N). In this range the sensor has proven to be reliable and precise.

**Mold and Magnets:** To guarantee consistent distances between magnets and sensors, we developed a multi-step casting process. A modular mold (laser-cut MDF sealed with vaseline [45]) were used to adapt the mold configuration to perform different casting steps. The process went as follows: (1) Casting the top of the ridges; (2) Initial curing about 30 minutes; (3) Placing magnets in the indents left by the lid of the mold; (4) Covering with silicone; (5) After a short curing phase placing the perforated layer; (6) Covering and sealing with silicone. Due to the shortened curing time, all silicone layers merged as molecules can still cross-link. The additional layer provides a rigid base that allows the ridges to be pulled while remaining the overall surface flat. A limitation of this method is the interference of the individual magnets, causing orientation and polarization changes when placed too close to each other, thus the resolution is restricted. We recommend using flat cylindrical ( $\varnothing 3 \times 1\text{ mm}$ ) over cubic ( $2 \times 2 \times 2\text{ mm}$ ) magnets (N45) to prevent flipping.

**Technology:** The interface can continuously measure and detect three event types (touch, push, pull) per sensor unit. To deduce interaction patterns, raw sensor values (read with 2 kHz) were converted to these events and considered in the time domain. Events were added to a timestamped stack, which was monitored for occurring patterns that were interpreted as performed gestures. Variations of the executed gestures have to be considered, since actions can be performed vertically or sloped resulting in event patterns differing in x-coordinates. Therefore, our algorithm considers the occurrence of ridge events in a specific time frame. Recognized patterns sent messages to a computer which visualized the information directly on the interaction surface using a projector.

**Interaction:** The second gen. prototype was not build for a specific use-case scenario. Instead, it enabled the experience and

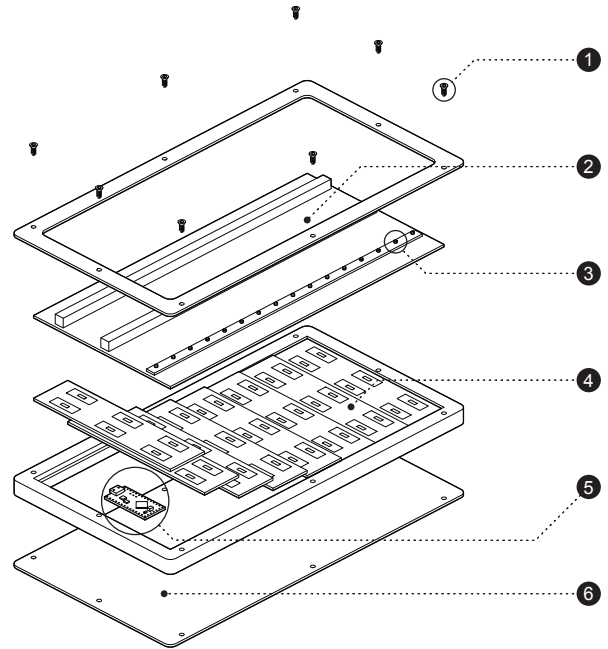

Figure 8: ① Screws ② Silicone interaction surface ③ Magnets ④ PCBs ⑤ Teensy LC ⑥ Enclosure

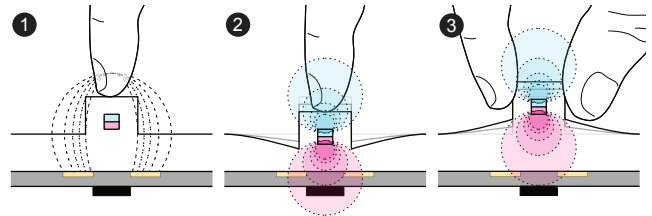

Figure 9: ① Without deformation, a finger increases the capacitance. Further, ② pushing reduces the distance between magnet and sensor (hall effect: high V), while ③ pulling increases the distance (low V).

exploration of the concept independent of a specific application area to generate insights about the interface's morphology and the ergonomics of the interactions. Therefore, the UI does not provide specific tasks but instead offers generic UI elements to explore the interaction. StringTouch is capable of tracking the hand's touch and displays, depending on its position, four interaction elements around the hand spread over the ridges (see Fig. 5). These elements can be pulled or pushed and the following gestures can be performed with the ridges: strumming, sliding and muting.

## 4.3 Design Sweet-spots

Since string instruments allow blind operation, we were interested in design features of the strings, such as size and texture, to be transferred to the silicone ridges. We were interested to see, how (1) size affords interactions and (2) texture creates differentiability. To evaluate the designs' influence, we let 16 participants interact

with 12 passive artifacts, which covered three design variations each regarding height, width, shape, surface texture (see Fig. 10). The participants performed the following tasks: Pushing, pulling, bending, and sliding. After each task, they rated their experience on a Likert scale (see Fig. 11). Further, they blindly distinguished the variations (10 sec) after a 30 second trial phase. We used the Friedman Test to test for significant differences regarding one dimension and one interaction (see Table 1) and the Wilcoxon Signed-Rank Test between pairs of these variations.

**Height:** We compared the users' response to pulling, pushing and bending ridges of 4, 6 and 8 mm height (width: 6mm) and found significant differences for pulling and bending. Our study revealed that both were hard to perform on the low design since these were harder to grab. Regarding pulling, both medium ( $p=.0004$ ,  $z=-3.5$ ) and high ( $p=.004$ ,  $z=-2.9$ ) designs were significantly superior. For bending, only the medium ( $p=.005$ ,  $z=-2.8$ ) height showed a significant improvement. This might be due to a decrease in stability and resistance of higher designs. The participants correctly differentiated the height of the artifacts to 91.67% while blindly touching the artifacts.

**Width:** Users had to pull, push and bend ridges with a width of 3, 6 and 9 mm (height: 4mm). We found significant differences for all of these interactions. Pulling and bending were significantly harder to perform on the thick ridges. We assume that this is due to the lower elasticity of thicker silicone elements. Both, the thin (pulling:  $p=.003$ ,  $z=-3.0$ ; bending:  $p=.01$ ,  $z=-2.5$ ) and the medium (pulling:  $p=.0006$ ,  $z=-3.4$ ; bending:  $p=.0009$ ,  $z=-3.3$ ) designs performed significantly better. However, for pushing the thin design showed to be the less liked variation. Both, medium ( $p=.0004$ ,  $z=-3.5$ ) and thick ( $p=.0006$ ,  $z=-3.4$ ) were rated significantly better. We assume that this as well is due to the lower stability due to lower thickness. The variations were distinguished with a precision of 95.83%.

**Shape:** Users performed the same interactions on three ridge shapes (straight, wavy, spiky). No significant differences could be found for the variations regarding the interactions. However, such as the structure of strings helps musicians to distinguish them haptically, participants successfully differentiated the shapes with a precision of 95.83%.

**Surface Texture:** Users had to slide along three surface texture types: smooth, dotted, striped. No differences were found regarding the different designs. Users preferred sliding along the dotted surface over the smooth one. The participants were able to differentiate texture with a precision of 95.83%.

Based on our findings we summarize that the ridges' design properties enabled blind differentiation (>91%) and thus potentially blind operation. Further, their design creates affordances for different interaction techniques. In our case the medium characteristics (close to the prototype's properties) provided a sweet-spot for the intended interactions.

#### 4.4 Design Implications

Based on our explorations and the analysis of the interplay between the design dimensions and the performability of interactions, we propose the following recommendations if practitioners and researchers are intended to utilize and substantiate our approach:

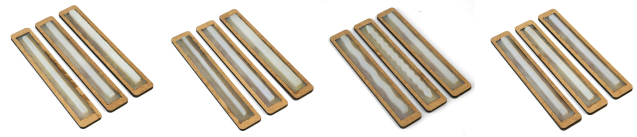

Figure 10: We built several experience artifacts that offered three variations of height, width, shape and texture each.

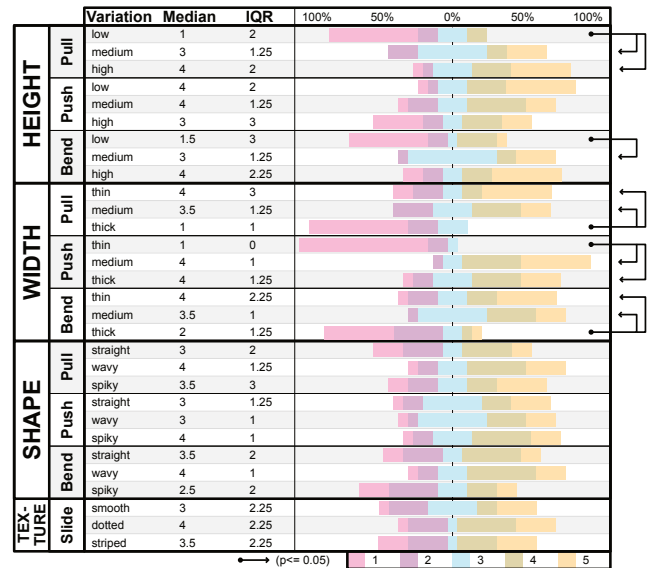

Figure 11: Users rated the interactions performed on the design variation (1 = not practicable, 5 = very practicable). Significant differences within a dimension are marked.

Table 1: Significant results: Friedman test for Repeated-Measure (N=16).

Dimension	Interaction	$\chi^2_r$	p
Height	Pull	14.7188	.00064
	Bend	9.375	.00921
Width	Pull	13.5313	.00115
	Push	23.8438	.00001
	Bend	10.7188	.0047

**Design creates Affordances:** The design of the ridges has to carefully consider the intended interaction affordances. Different types of interactions are preferably performed on larger, thinner or stiffer designs.

**Design enables Distinction:** Based on the need for visibility during interaction it can be helpful to offer passive haptic features, e.g. shaped or textured ridges, to enable differentiation due to the tactile experience.

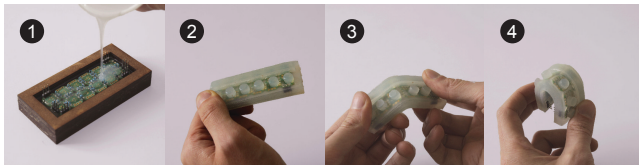

Figure 12: ❶ The PCB is embedded in the silicone cast. ❷ The unbroken sensor is rigid. After ❸ breaking, it can easily be ❹ bent. Such sensor can be used in non planar interfaces such as freely shaped design objects.

## 5 DISCUSSION

During our investigation of string instruments as a resource for TUI design, we collected a profound set of interaction techniques and deduced a new tangible interface morphology. While we showed that the concept can be implemented in a specific use case (automotive), we further explored it on a generic UI level to understand the implications of the instrument morphology onto the interface context. Therefore we merged properties of touch screens, flexible screens, and tangible interfaces and used strings as an inspiration to inform physical control elements on a touch surface.

While HCI research considers string instruments mainly regarding the instrument's augmentation [4, 20, 22, 39], the expressive performance [37], or the use of strings as a new musical interface [57], we were interested in going beyond a metaphorical [5] or skeuomorph [18] design approach, focusing on the instruments morphology and physical affordances, finally using their potential outside the musical context.

Rather than directly rebuilding or reusing a string instrument, we drew inspiration from this rich resource and sought to explore and investigate the implications arising from our design concepts. During this research through design [64] phase we slowly moved away from a closer resemblance towards a more abstract interface form that still refers to and takes into account the interaction principles of string instruments.

While our current design exploration does not yet allow us to make definitive statements about whether or how our concepts improve the user experience and other measures compared to touch-only interfaces. We see the potential that such hybrid flexible tangible interfaces allow “*the user to go deeper than with regular multi-touch surfaces*” [42]. E.g. we already showed that tangible features inspired by string instruments afford interactions deduced from this resource and benefit interaction advantages such as the blind operation based on tactile distinctiveness. Which shows that by considering the presented design resource, interfaces can facilitate and aggravate desired interactions and properties.

Our sensor design, which is capable to differentiate touch and deformation, further could lead to interfaces that allow for a tangible interaction without triggering the interface unintentionally. This is a well known problem of touch interfaces [21] or better known as the *Midas Touch Problem* [26] in the context of gaze interaction.

Our generic prototype proofed to be helpful to stimulate the discussion with HCI experts. The experience could be used as a sandbox or petri dish to brainstorm application ideas outside the musical domain such as: **Discreet Interaction** using string inspired

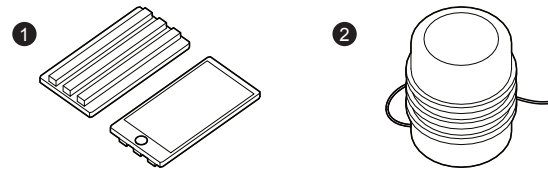

Figure 13: ❶ Ridges on the back of smart devices could enable discreet and versatile interaction. ❷ Cylindrical UIs such as smart speakers could be controlled collaboratively from all angles simultaneously.

interaction elements to perform subtle gestures and motions in situations requiring discreetness [30] during *back of device* interaction [3] or in *smart clothes* [25]; for **Professional User Interfaces** based on the versatile and expressive interaction capabilities of string-instruments which could benefit pilots [41] or flight controllers; **Collaborative Interfaces** regarding the context of shared interface surfaces [33] such as home entertainment and smart speakers; and in situations which require **Reduced Visual Attention** due to the tangibility of the interface to improve automotive [10] and performative contexts [40]. While both prototype iterations currently only used a subset of the collected string instrument interactions, we see the opportunity to investigate unconsidered interactions in the context of the proposed application scenarios.

## 6 CONCLUSION

In this paper we presented our research through design approach for the exploration of string instrument interactions and morphology and their transfer into novel UI interaction and interface concepts. Our exploration generated a set of interaction principles taken from string instruments, which act as a resource for developing rich interactions with hybrid flexible and tangible touch interfaces. These interactions offer users access to technology based on their in-/directly achieved prior knowledge.

In concrete terms, we started with string instruments as a source for inspiration, implemented two prototype generations taking into account string instruments' design, and generated insights and ideas throughout the exploration of the physical artifacts. Our next steps will lead us to composite flexible interactive silicone elements (see Fig. 12) which enable interface designs in the context of non planar UI surfaces (see Fig. 13). We will further refine the sensor technology to increase the input expressiveness and focus on the evaluation of usability, user experience and on the side by side comparisons with today's UI standards.

With our work we aim to inspire practitioners and researchers to take inspiration from real world resources and thus design strong interactions for the next generation of user interfaces. While other HCI projects already explored string instruments in the musical context, we think that arts and crafts can further act as resources to inspire new interaction principles and finally lead to interfaces that incorporate strong concepts and insights from the *art of interaction* which traditional interfaces such as string instruments provide.



## ACKNOWLEDGMENTS

We would like to thank Romy Martin, Alexander Schenker, and Bernhard Vogler, who were significantly involved in the realization of the first prototype and the development of the original idea, as well as Anna-Carina Gehlisch, Paolo Holinski, Nikolai Kraler, and Katharina Rupp for prototyping and conducting the user study of the experience artifacts.

## REFERENCES

- [1] Chadia Abras, Diane Maloney-Krichmar, Jenny Preece, et al. 2004. User-centered design. *Bainbridge, W. Encyclopedia of Human-Computer Interaction. Thousand Oaks: Sage Publications* 37, 4 (2004), 445–456.
- [2] Leonardo Angelini, Jürgen Baumgartner, Francesco Carrino, Stefano Carrino, Maurizio Caon, Omar Abou Khaled, Jürgen Sauer, Denis Lalanne, Elena Mugellini, and Andreas Sonderegger. 2016. A Comparison of Three Interaction Modalities in the Car: Gestures, Voice and Touch. In *Actes de La 28ième Conférence Francophone Sur l'Interaction Homme-Machine (Eribourg, Switzerland) (IHM '16)*. Association for Computing Machinery, New York, NY, USA, 188–196. <https://doi.org/10.1145/3004107.3004118>
- [3] Patrick Baudisch and Gerry Chu. 2009. Back-of-device Interaction Allows Creating Very Small Touch Devices. In *Proceedings of the SIGCHI Conference on Human Factors in Computing Systems (Boston, MA, USA) (CHI '09)*. ACM, New York, NY, USA, 1923–1932. <https://doi.org/10.1145/1518701.1518995>
- [4] Edgar Berdahl and Julius O. Smith. 2008. A Tangible Virtual Vibrating String : A Physically Motivated Virtual Musical Instrument Interface. In *Proceedings of the International Conference on New Interfaces for Musical Expression*. Genoa, Italy, 299–302. <https://doi.org/10.5281/zenodo.1179493>
- [5] Alan F. Blackwell. 2006. The Reification of Metaphor as a Design Tool. *ACM Trans. Comput.-Hum. Interact.* 13, 4 (Dec. 2006), 490–530. <https://doi.org/10.1145/1188816.1188820>
- [6] Alberto Boem and Giovanni Maria Troiano. 2019. Non-Rigid HCI: A Review of Deformable Interfaces and Input. In *Proceedings of the 2019 on Designing Interactive Systems Conference (San Diego, CA, USA) (DIS '19)*. Association for Computing Machinery, New York, NY, USA, 885–906. <https://doi.org/10.1145/3322276.3322347>
- [7] Simon Butscher, Maximilian Dürr, and Harald Reiterer. 2017. InformationSense: Trade-offs for the Design and the Implementation of a Large Highly Deformable Cloth Display. *Proc. ACM Interact. Mob. Wearable Ubiquitous Technol.* 1, 2, Article 7 (June 2017), 28 pages. <https://doi.org/10.1145/3090053>
- [8] John Raymond Callahan, Don Hopkins, Mark David Weiser, and Ben Shneiderman. 1988. An Empirical Comparison of Pie vs. Linear Menus. In *Proceedings of the SIGCHI Conference on Human Factors in Computing Systems (Washington, D.C., USA) (CHI '88)*. ACM, New York, NY, USA, 95–100. <https://doi.org/10.1145/57167.57182>
- [9] Kyung Yun Choi and Hiroshi Ishii. 2020. AmbienBeat: Wrist-Worn Mobile Tactile Biofeedback for Heart Rate Rhythmic Regulation. In *Proceedings of the Fourteenth International Conference on Tangible, Embedded, and Embodied Interaction (Sydney NSW, Australia) (TEI '20)*. Association for Computing Machinery, New York, NY, USA, 17–30. <https://doi.org/10.1145/3374920.3374938>
- [10] Ronald Ecker, Verena Broy, Andreas Butz, and Alexander De Luca. 2009. pieTouch: A Direct Touch Gesture Interface for Interacting with In-vehicle Information Systems. In *Proceedings of the 11th International Conference on Human-Computer Interaction with Mobile Devices and Services (Bonn, Germany) (MobileHCI '09)*. ACM, New York, NY, USA, Article 22, 10 pages. <https://doi.org/10.1145/1613858.1613887>
- [11] Harald Emmerich and Martin Schöfthaler. 2000. Magnetic field measurements with a novel surface micromachined magnetic-field sensor. *IEEE Transactions on Electron Devices* 47, 5 (May 2000), 972–977. <https://doi.org/10.1109/16.841228>
- [12] Anna Maria Feit and Antti Oulasvirta. 2014. PianoText: Redesigning the Piano Keyboard for Text Entry. In *Proceedings of the 2014 Conference on Designing Interactive Systems (Vancouver, BC, Canada) (DIS '14)*. ACM, New York, NY, USA, 1045–1054. <https://doi.org/10.1145/2598510.2598547>
- [13] Sean Follmer, Daniel Leithinger, Alex Olwal, Nadia Cheng, and Hiroshi Ishii. 2012. Jamming User Interfaces: Programmable Particle Stiffness and Sensing for Malleable and Shape-changing Devices. In *Proceedings of the 25th Annual ACM Symposium on User Interface Software and Technology (Cambridge, Massachusetts, USA) (UIST '12)*. ACM, New York, NY, USA, 519–528. <https://doi.org/10.1145/2380116.2380181>
- [14] Sean Follmer, Daniel Leithinger, Alex Olwal, Akimitsu Hogue, and Hiroshi Ishii. 2013. inFORM: Dynamic Physical Affordances and Constraints Through Shape and Object Actuation. In *Proceedings of the 26th Annual ACM Symposium on User Interface Software and Technology (St. Andrews, Scotland, United Kingdom) (UIST '13)*. ACM, New York, NY, USA, 417–426. <https://doi.org/10.1145/2501988.2502032>
- [15] Takanori Fukushi, Sung Hoon Kim, Shuichiro Hashi, and Kazushi Ishiyama. 2013. Magnetic silicone rubber: Fabrication and analysis with applications. *Journal of the Korean Physical Society* 63, 3 (01 Aug 2013), 686–690. <https://doi.org/10.3938/jkps.63.686>
- [16] Harriet Rosemary Ann Gaywood. 1996. *Guqin and Guzheng: the historical and contemporary development of two Chinese musical instruments*. Ph.D. Dissertation. Durham University.
- [17] Kristian Gohlke, Eva Hornecker, and Wolfgang Sattler. 2016. Pneumatibles: Exploring Soft Robotic Actuators for the Design of User Interfaces with Pneumotactile Feedback. In *Proceedings of the TEI '16: Tenth International Conference on Tangible, Embedded, and Embodied Interaction (Eindhoven, Netherlands) (TEI '16)*. ACM, New York, NY, USA, 308–315. <https://doi.org/10.1145/2839462.2839489>
- [18] Shad Gross, Jeffrey Bardzell, and Shaowen Bardzell. 2014. Skeu: The Evolution: Skeuomorphs, Style, and the Material of Tangible Interactions. In *Proceedings of the 8th International Conference on Tangible, Embedded and Embodied Interaction (Munich, Germany) (TEI '14)*. Association for Computing Machinery, New York, NY, USA, 53–60. <https://doi.org/10.1145/2540930.2540969>
- [19] Tobias Grosshauser and Gerhard Tröster. 2013. Finger Position and Pressure Sensing Techniques for String and Keyboard Instruments. In *Proceedings of the International Conference on New Interfaces for Musical Expression*. Graduate School of Culture Technology, KAIST, Daejeon, Republic of Korea, 479–484. [http://nime.org/proceedings/2013/nime2013\\_286.pdf](http://nime.org/proceedings/2013/nime2013_286.pdf)
- [20] Jacob Harrison, Robert H Jack, Fabio Morreale, and Andrew P. McPherson. 2018. When is a Guitar not a Guitar? Cultural Form, Input Modality and Expertise. In *Proceedings of the International Conference on New Interfaces for Musical Expression*. Thomas Martin Luke Dahl, Douglas Bowman (Ed.). Virginia Tech, Blacksburg, Virginia, USA, 299–304. <https://doi.org/10.5281/zenodo.1302589>
- [21] Ken Hincle, Seongkook Heo, Michel Pahud, Christian Holz, Hrvoje Benko, Abigail Sellen, Richard Banks, Kenton O'Hara, Gavin Smyth, and William Buxton. 2016. Pre-Touch Sensing for Mobile Interaction. In *Proceedings of the 2016 CHI Conference on Human Factors in Computing Systems (San Jose, California, USA) (CHI '16)*. Association for Computing Machinery, New York, NY, USA, 2869–2881. <https://doi.org/10.1145/2858036.2858095>
- [22] Echo Ho, Prof. Dr. Phil. Alberto de Campo, and Hannes Hoelzl. 2019. The SlowQin: An Interdisciplinary Approach to reinventing the Guqin. In *Proceedings of the International Conference on New Interfaces for Musical Expression*, Marcelo Queiroz and Anna Xambó Sedó (Eds.). UFRGS, Porto Alegre, Brazil, 256–259. <https://doi.org/10.5281/zenodo.3672948>
- [23] David Holman and Roel Vertegaal. 2008. Organic User Interfaces: Designing Computers in Any Way, Shape, or Form. *Commun. ACM* 51, 6 (June 2008), 48–55. <https://doi.org/10.1145/1349026.1349037>
- [24] Eva Hornecker. 2011. The Role of Physicality in Tangible and Embodied Interactions. *interactions* 18, 2 (March 2011), 19–23. <https://doi.org/10.1145/1925820.1925826>
- [25] Cindy Jacob and Bruno Dumas. 2014. Designing for Intimacy: How Fashion Design Can Address Privacy Issues in Wearable Computing. In *Proceedings of the 2014 ACM International Symposium on Wearable Computers: Adjunct Program (Seattle, Washington) (ISWC '14 Adjunct)*. ACM, New York, NY, USA, 185–192. <https://doi.org/10.1145/2641248.2641353>
- [26] Robert JK Jacob. 1993. Eye movement-based human-computer interaction techniques: Toward non-command interfaces. *Advances in human-computer interaction* 4 (1993), 151–190.
- [27] Heekyoung Jung, Heather Wiltse, Mikael Wiberg, and Erik Stolterman. 2017. Metaphors, materialities, and affordances: Hybrid morphologies in the design of interactive artifacts. *Design Studies* 53 (2017), 24 – 46. <https://doi.org/10.1016/j.destud.2017.06.004>
- [28] Melvin Khoo and Chang Liu. 2001. Micro magnetic silicone elastomer membrane actuator. *Sensors and Actuators A: Physical* 89 (04 2001), 259–266. [https://doi.org/10.1016/S0924-4247\(00\)00559-8](https://doi.org/10.1016/S0924-4247(00)00559-8)
- [29] Scott R. Klemmer, Björn Hartmann, and Leila Takayama. 2006. How Bodies Matter: Five Themes for Interaction Design. In *Proceedings of the 6th Conference on Designing Interactive Systems (University Park, PA, USA) (DIS '06)*. ACM, New York, NY, USA, 140–149. <https://doi.org/10.1145/1142405.1142429>
- [30] Juyoung Lee, Hui-Shyong Yeo, Murtaza Dhuliwala, Jedidiah Akano, Junichi Shimizu, Thad Starner, Aaron Quigley, Woontack Woo, and Kai Kunze. 2017. Itchy Nose: Discreet Gesture Interaction Using EOG Sensors in Smart Eyewear. In *Proceedings of the 2017 ACM International Symposium on Wearable Computers (Maui, Hawaii) (ISWC '17)*. ACM, New York, NY, USA, 94–97. <https://doi.org/10.1145/3123021.3123060>
- [31] Rong-Hao Liang, Liwei Chan, Hung-Yu Tseng, Han-Chih Kuo, Da-Yuan Huang, De-Nian Yang, and Bing-Yu Chen. 2014. Gaussbricks: Magnetic Building Blocks for Constructive Tangible Interactions on Portable Displays. In *CHI '14 Extended Abstracts on Human Factors in Computing Systems (Toronto, Ontario, Canada) (CHI EA '14)*. ACM, New York, NY, USA, 587–590. <https://doi.org/10.1145/2559206.2574776>
- [32] Markus Löchtfeld, Sven Gehring, Ralf Jung, and Antonio Krüger. 2011. guitAR: Supporting Guitar Learning Through Mobile Projection. In *CHI '11 Extended Abstracts on Human Factors in Computing Systems (Vancouver, BC, Canada) (CHI EA '11)*. ACM, New York, NY, USA, 1447–1452. <https://doi.org/10.1145/1979742>

- 1979789
- [33] Paul Marshall, Eva Hornecker, Richard Morris, Nick Sheep Dalton, and Yvonne Rogers. 2008. When the fingers do the talking: A study of group participation with varying constraints to a tabletop interface. In *2008 3rd IEEE International Workshop on Horizontal Interactive Human Computer Systems*. 33–40. <https://doi.org/10.1109/TABLETOP.2008.4660181>
- [34] Carolina Brum Medeiros and Marcelo M Wanderley. 2014. A comprehensive review of sensors and instrumentation methods in devices for musical expression. *Sensors* 14, 8 (2014), 13556–13591. <https://doi.org/10.3390/s140813556>
- [35] Mathias Müller, Anja Knöfel, Thomas Gründer, Ingmar Franke, and Rainer Groh. 2014. FlexiWall: Exploring Layered Data with Elastic Displays. In *Proceedings of the Ninth ACM International Conference on Interactive Tabletops and Surfaces (Dresden, Germany) (ITS '14)*. ACM, New York, NY, USA, 439–442. <https://doi.org/10.1145/2669485.2669529>
- [36] Donald Arthur Norman. 2002. *The Design of Everyday Things*. Basic Books, Inc., New York, NY, USA.
- [37] Dan Overholt. 2012. Violin-Related HCI: A Taxonomy Elicited by the Musical Interface Technology Design Space. In *Arts and Technology*, Anthony L. Brooks (Ed.). Springer Berlin Heidelberg, Berlin, Heidelberg, 80–89.
- [38] Jimmie Paloranta, Anders Lundström, Ludvig Elblaus, Roberto Bresin, and Emma Frid. 2016. Interaction with a large sized augmented string instrument intended for a public setting. In *Proceedings Sound and Music Computing 2016 (SMC)*, Rolf Großmann and Georg Hajdu (Eds.). Hamburg: Zentrum für Mikrotonale Musik und Multimediale Komposition (ZM4), 388–395.
- [39] Laurel Pardue, Kuriijn Buys, Dan Overholt, Andrew P. McPherson, and Michael Edinger. 2019. Separating sound from source: sonic transformation of the violin through electrodynamic pickups and acoustic actuation. In *Proceedings of the International Conference on New Interfaces for Musical Expression*, Marcelo Queiroz and Anna Xambó Sedó (Eds.). UFRGS, Porto Alegre, Brazil, 278–283. <https://doi.org/10.5281/zenodo.3672958>
- [40] James Patten, Ben Recht, and Hiroshi Ishii. 2006. Interaction Techniques for Musical Performance with Tabletop Tangible Interfaces. In *Proceedings of the 2006 ACM SIGCHI International Conference on Advances in Computer Entertainment Technology (Hollywood, California, USA) (ACE '06)*. ACM, New York, NY, USA, Article 27. <https://doi.org/10.1145/1178823.1178856>
- [41] Sylvain Pauchet, Jean-Luc Vinot, Catherine Letondal, Alexandre Lemort, Claire Lavenir, Timothée Lecomte, Stéphanie Rey, Valentin Becquet, and Guillaume Crouzet. 2019. Multi-plié: A Linear Foldable and Flattenable Interactive Display to Support Efficiency, Safety and Collaboration. In *Proceedings of the 2019 CHI Conference on Human Factors in Computing Systems (Glasgow, Scotland UK) (CHI '19)*. ACM, New York, NY, USA, Article 154, 13 pages. <https://doi.org/10.1145/3290605.3300384>
- [42] Joshua Peschke, Fabian Göbel, Thomas Gründer, Mandy Keck, Dietrich Kammer, and Rainer Groh. 2012. DepthTouch: An Elastic Surface for Tangible Computing. In *Proceedings of the International Working Conference on Advanced Visual Interfaces (Capri Island, Italy) (AVI '12)*. ACM, New York, NY, USA, 770–771. <https://doi.org/10.1145/2254556.2254706>
- [43] Isabel P. S. Qamar, Rainer Groh, David Holman, and Anne Roudaut. 2018. HCI Meets Material Science: A Literature Review of Morphing Materials for the Design of Shape-Changing Interfaces. In *Proceedings of the 2018 CHI Conference on Human Factors in Computing Systems (Montreal QC, Canada) (CHI '18)*. ACM, New York, NY, USA, Article 374, 23 pages. <https://doi.org/10.1145/3173574.3173948>
- [44] Majken Rasmussen, Esben Pedersen, Marianne Petersen, and Kasper Hornbæk. 2012. Shape-changing interfaces: A review of the design space and open research questions. *Conference on Human Factors in Computing Systems - Proceedings*. <https://doi.org/10.1145/2207676.2207781>
- [45] Beat Rossmly and Alexander Wiethoff. 2019. COMB – Shape As a Meaningful Element of Interaction. In *Proceedings of the Thirteenth International Conference on Tangible, Embedded, and Embodied Interaction (Tempe, Arizona, USA) (TEI '19)*. ACM, New York, NY, USA, 287–295. <https://doi.org/10.1145/3294109.3295646>
- [46] Beat Rossmly and Alexander Wiethoff. 2019. StringTouch: A Scalable Low-Cost Concept for Deformable Interfaces. In *Extended Abstracts of the 2019 CHI Conference on Human Factors in Computing Systems (Glasgow, Scotland UK) (CHI EA '19)*. Association for Computing Machinery, New York, NY, USA, 1–4. <https://doi.org/10.1145/3290607.3313245>
- [47] Curt Sachs. 2012. *The history of musical instruments*. Courier Corporation.
- [48] Deepak Ranjan Sahoo, Kasper Hornbæk, and Sriram Subramanian. 2016. TableHop: An Actuated Fabric Display Using Transparent Electrodes. In *Proceedings of the 2016 CHI Conference on Human Factors in Computing Systems (San Jose, California, USA) (CHI '16)*. ACM, New York, NY, USA, 3767–3780. <https://doi.org/10.1145/2858036.2858544>
- [49] Philipp Schoessler, Sang-won Leigh, Krithika Jagannath, Patrick van Hoof, and Hiroshi Ishii. 2015. Cord UIs: Controlling Devices with Augmented Cables. In *Proceedings of the Ninth International Conference on Tangible, Embedded, and Embodied Interaction (Stanford, California, USA) (TEI '15)*. ACM, New York, NY, USA, 395–398. <https://doi.org/10.1145/2677199.2680601>
- [50] Ronit Slyper, Ivan Poupyrev, and Jessica Hodgins. 2011. Sensing Through Structure: Designing Soft Silicone Sensors. In *Proceedings of the Fifth International Conference on Tangible, Embedded, and Embodied Interaction (Funchal, Portugal) (TEI '11)*. ACM, New York, NY, USA, 213–220. <https://doi.org/10.1145/1935701.1935744>
- [51] David Strayer, Joel Cooper, Rachel Goethe, Madeleine McCarty, Douglas Getty, and Francesco Biondi. 2019. Assessing the visual and cognitive demands of in-vehicle information systems. *Cognitive Research: Principles and Implications* 4 (12 2019). <https://doi.org/10.1186/s41235-019-0166-3>
- [52] Miriam Sturdee and Jason Alexander. 2018. Analysis and Classification of Shape-Changing Interfaces for Design and Application-based Research. *ACM Comput. Surv.* 51, 1, Article 2 (Jan. 2018), 32 pages. <https://doi.org/10.1145/3143559>
- [53] Yuta Sugiura, Gota Kakehi, Anusha Withana, Calista Lee, Daisuke Sakamoto, Maki Sugimoto, Masahiko Inami, and Takeo Igarashi. 2011. Detecting Shape Deformation of Soft Objects Using Directional Photoreflectivity Measurement. In *Proceedings of the 24th Annual ACM Symposium on User Interface Software and Technology (Santa Barbara, California, USA) (UIST '11)*. ACM, New York, NY, USA, 509–516. <https://doi.org/10.1145/2047196.2047263>
- [54] Ataru Tanaka. 2000. Musical performance practice on sensor-based instruments. *Trends in Gestural Control of Music* 13, 389-405 (2000), 284.
- [55] Marc Teyssier, Gilles Bailly, Catherine Pelachaud, Eric Lecolinet, Andrew Conn, and Anne Roudaut. 2019. Skin-On Interfaces: A Bio-Driven Approach for Artificial Skin Design to Cover Interactive Devices. In *Proceedings of the 32nd Annual ACM Symposium on User Interface Software and Technology (New Orleans, LA, USA) (UIST '19)*. Association for Computing Machinery, New York, NY, USA, 307–322. <https://doi.org/10.1145/3332165.3347943>
- [56] Karen Vanderloock, Vero Vanden Abeele, Johan A.K. Suykens, and Luc Geurts. 2013. The Skweezee System: Enabling the Design and the Programming of Squeeze Interactions. In *Proceedings of the 26th Annual ACM Symposium on User Interface Software and Technology (St. Andrews, Scotland, United Kingdom) (UIST '13)*. ACM, New York, NY, USA, 521–530. <https://doi.org/10.1145/2501988.2502033>
- [57] Jens Vetter and Sarah Leimcke. 2017. Homo Restis - Constructive Control Through Modular String Topologies. In *Proceedings of the International Conference on New Interfaces for Musical Expression*. Aalborg University Copenhagen, Copenhagen, Denmark, 83–86. [http://www.nime.org/proceedings/2017/nime2017\\_paper0017.pdf](http://www.nime.org/proceedings/2017/nime2017_paper0017.pdf)
- [58] Erich M Von Hornbostel and Curt Sachs. 1914. Systematik der Musikinstrumente. Ein Versuch. *Zeitschrift für Ethnologie* 46, H. 4/5 (1914), 553–590.
- [59] Martin Weigel, Tong Lu, Gilles Bailly, Antti Oulasvirta, Carmel Majidi, and Jürgen Steimle. 2015. iSkin: Flexible, Stretchable and Visually Customizable On-Body Touch Sensors for Mobile Computing. In *Proceedings of the 33rd Annual ACM Conference on Human Factors in Computing Systems (Seoul, Republic of Korea) (CHI '15)*. ACM, New York, NY, USA, 2991–3000. <https://doi.org/10.1145/2702123.2702391>
- [60] Raphael Wimmer and Patrick Baudisch. 2011. Modular and Deformable Touch-sensitive Surfaces Based on Time Domain Reflectometry. In *Proceedings of the 24th Annual ACM Symposium on User Interface Software and Technology (Santa Barbara, California, USA) (UIST '11)*. ACM, New York, NY, USA, 517–526. <https://doi.org/10.1145/2047196.2047264>
- [61] Lining Yao, Sayamindu Dasgupta, Nadia Cheng, Jason Spingarn-Koff, Ostap Rudakevych, and Hiroshi Ishii. 2011. Rope Revolution: Tangible and Gestural Rope Interface for Collaborative Play. In *Proceedings of the 8th International Conference on Advances in Computer Entertainment Technology (Lisbon, Portugal) (ACE '11)*. ACM, New York, NY, USA, Article 11, 8 pages. <https://doi.org/10.1145/2071423.2071437>
- [62] Lining Yao, Ryuma Niiyama, Jifei Ou, Sean Follmer, Clark Della Silva, and Hiroshi Ishii. 2013. PneuUI: Pneumatically Actuated Soft Composite Materials for Shape Changing Interfaces. In *Proceedings of the 26th Annual ACM Symposium on User Interface Software and Technology (St. Andrews, Scotland, United Kingdom) (UIST '13)*. ACM, New York, NY, USA, 13–22. <https://doi.org/10.1145/2501988.2502037>
- [63] Lining Yao, Jifei Ou, Chin-Yi Cheng, Helene Steiner, Wen Wang, Guanyun Wang, and Hiroshi Ishii. 2015. bioLogic: Natto Cells As Nanoactuators for Shape Changing Interfaces. In *Proceedings of the 33rd Annual ACM Conference on Human Factors in Computing Systems (Seoul, Republic of Korea) (CHI '15)*. ACM, New York, NY, USA, 1–10. <https://doi.org/10.1145/2702123.2702611>
- [64] John Zimmerman, Jodi Forlizzi, and Shelley Evenson. 2007. Research through Design as a Method for Interaction Design Research in HCI. In *Proceedings of the SIGCHI Conference on Human Factors in Computing Systems (San Jose, California, USA) (CHI '07)*. Association for Computing Machinery, New York, NY, USA, 493–502. <https://doi.org/10.1145/1240624.1240704>