

Prototyping Tools for Hybrid Interactions

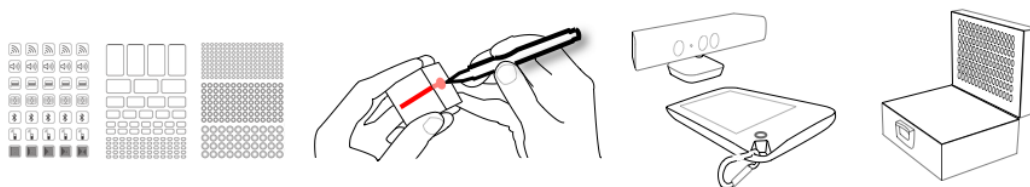

Alexander Wiethoff

Erstgutachter: Prof. Andreas Butz
Zweitgutachter: Prof. Saul Greenberg

Tag der mündlichen Prüfung: 06. Dezember 2012

Dissertation

an der Fakultät für Mathematik, Informatik und Statistik
der Ludwig-Maximilians-Universität München

von

Alexander Wiethoff

Oktober 2012

Abstract

In using the term 'hybrid interactions', we refer to interaction forms that comprise both tangible and intangible interactions as well as a close coupling of the physical or embodied representation with digital output. Until now, there has been no description of a formal design process for this emerging research domain, no description that can be followed during the creation of these types of interactions. As a result, designers face limitations in prototyping these systems.

In this thesis, we share our systematic approach to envisioning, prototyping, and iteratively developing these interaction forms by following an extended interaction design process. We share our experiences with process extensions in the form of toolkits, which we built for this research and utilized to aid designers in the development of hybrid interactive systems.

The proposed tools incorporate different characteristics and are intended to be used at different points in the design process. In *Sketching with Objects*, we describe a low-fidelity toolkit that is intended to be used in the very early phases of the process, such as ideation and user research. By introducing *Paperbox*, we present an implementation to be used in the mid-process phases for finding the appropriate *mapping* between physical representation and digital content during the creation of tangible user interfaces (TUI) atop interactive surfaces. In a follow-up project, we extended this toolkit to also be used in conjunction with capacitive sensing devices. To do this, we implemented *Sketch-a-TUI*. This approach allows designers to create TUIs on capacitive sensing devices rapidly and at low cost. To lower the barriers for designers using the toolkit, we created the *Sketch-a-TUIApp*, an application that allows even novice users (users without previous coding experience) to create early instantiations of TUIs.

In order to prototype intangible interactions, we used *open soft- and hardware components* and proposed an approach of investigating interactivity in correlation with intangible interaction forms on a higher fidelity. With our final design process extension, *Lightbox*, we assisted a design team in systematically developing a remote interaction system connected to a media façade covering a building.

All of the above-mentioned toolkits were explored both in real-life contexts and in projects with industrial partners. The evaluation was therefore mainly performed *in the wild*, which led to the adaptation of metrics suitable to the individual cases and contexts.

Zusammenfassung

Unter dem Sammelbegriff *Hybrid Interactions* verstehen wir Interaktionen, die physikalische oder immaterielle Bedienelemente einbeziehen. Diese Bezeichnung beinhaltet ausserdem eine *enge Verbindung* zwischen physikalischer oder verkörperter Interaktion und digitaler Darstellung der Nutzerschnittstelle. Es existiert jedoch kein allgemeingültiger Entwicklungsprozess den die mit der Gestaltung solcher Systeme betrauten Designer und Entwickler anwenden können. Eine Tatsache welche die systematische Entwicklung dieser neuartigen Interaktionsformen erschwert. In dieser Doktorarbeit präsentieren wir unseren Ansatz zur Erstellung hybrider Interaktionen mit der Hilfe von Designprozess-Werkzeugen.

Unsere vorgeschlagenen Werkzeuge können an verschiedenen Stellen im Design-Prozess eingesetzt zu werden: Mit *Sketching with Objects* präsentieren wir ein Werkzeug auf einer niedrigen Genauigkeitsstufe, das in sehr frühen Prozessphasen wie Ideenfindung und Nutzerforschung verwendet werden soll. Eine weitere Implementierung, *Paperbox*, bietet eine Methode für mittlere Designprozess-Phasen bei der Gestaltung von begreifbaren Interaktionen auf interaktiven Oberflächen. Im Verlauf unserer Forschungstätigkeit haben wir dieses Werkzeug erweitert, um auch in Verbindung mit graphischen, kapazitiven Oberflächen (z.B. iPad) verwendet werden zu können. Das für diesen Zweck erarbeitete Werkzeug *Sketch-a-TUI* ermöglicht Designern ein schnelles und kostengünstiges Entwerfen von interaktiven, physikalischen Objekten auf interaktiven Oberflächen. Für Nutzer ohne Programmierkenntnisse bietet die *Sketch-a-TUIApp* die Möglichkeit frühe Instanzen von begreifbaren Interaktionen selbständig zu erzeugen.

Um hybride immaterielle Interaktionen systematisch zu gestalten, untersuchten wir die Verwendung von frei verfügbaren *Soft- und Hardwarekomponenten*. Durch diese Vorgehensweise stellen wir einen Ansatz zur prozessorientierten Erstellung von Prototypen in Verbindung mit immaterieller Interaktion vor. Ein weiteres Werkzeug für die Gestaltung von räumlich getrennten Interaktionen, *Lightbox*, unterstützte ein Designteam bei der Entwicklung einer räumlich getrennten (Nutzer-) Schnittstelle in Verbindung mit einer Medienfassade.

Alle in dieser Doktorarbeit vorgestellten Werkzeuge wurden in Feldstudien durch Projekte mit Partnern aus der Industrie erforscht. Die Evaluation wurde daher hauptsächlich ausserhalb des Labors absolviert und resultierte in einer Anpassung der verwendeten Methoden im jeweiligen Kontext.

Preface

This dissertation partially fulfills the requirements for obtaining the degree of Doctor of Natural Sciences in the Department of Mathematics, Informatics and Statistics at the University of Munich (*Ludwig-Maximilians Universität München*). Under the supervision of Andreas Butz, I was hired as an HCI researcher for the Human-Machine Interaction work group where, from May 2009 to October 2012, I conducted most of the research presented in this dissertation.

During my time as a researcher, I was part of the interdisciplinary project ‘PREMIUM’, funded by the German Research Association (DFG). The project was aimed at improving design processes for hybrid interaction forms and served as a contextual framework for that work. During this period, I had the opportunity to work closely with both academic and industrial research institutions. These included, for example, the German Research Center for Artificial Intelligence (DFKI) and Sven Gehring in particular, with whom I was involved in an intense project together with the ARS Electronica Center in Linz, Austria.

I also collaborated with various companies in our research projects and received feedback from the industrial point of view, as well as the opportunity to exchange thoughts and ideas. The main collaborators involved in the research presented here were the Pinakothek der Moderne, Neff (BSH), Ultratronik, and Feno, all based in and around Munich, Germany.

Since all of the work has been carried out in collaboration with professionals, students, associate researchers and artists, I have chosen to use the scientific plural ‘we’ throughout the written document. The colleagues who contributed primarily by carrying out the research work and co-authoring scientific publications are included at the beginning of each section via direct references in the footnotes. Many individuals from both academic and industrial research institutions participated in the study settings, negotiated contracts behind the scenes, and contributed to the project in a myriad of other ways, and it is almost impossible to thank every person individually. However, I will try my best to address some of the main contributors in the following section, and apologize to those who are not included individually.

Acknowledgements

I would like to thank my first advisor, **Andreas Butz**, for initiating this research project, supervising my thesis and always providing an open ear for new ideas. Further, I would like to thank my second advisor, **Saul Greenberg**, for his support during the thesis period and for sharing his professional expertise in a joint publication. I would like to thank **Heinrich Hussmann** for always being supportive with both advice and funding, **Bettina Conradi** for fighting work-intensive projects with me and for being a great colleague and office mate.

The research lab at which I worked during the project provided great opportunities for collaboration, fun, inspiration and new ideas. I am deeply grateful to my colleagues at the LMU Munich for providing me with many memorable moments during these years: **Hendrik Richter** for his sense of humor and for being a great colleague and office mate, **Alexander de Luca** for his feedback and the organization of social events, **Max-Maurer** for helping me save time with his outstanding inventions, **Sara Streng** for teaching me how the LMU works, **Michael Rohs** for sharing his knowledge and skills, **Gregor Broll** for his ability to never give up on a paper and *NFC*, **Raphael Wimmer** for great times during the *Sketching in Hardware* courses and an unforgettable *IDC presentation*, **Doris Hausen** for struggling with me through various lecture series and enlightening the chaos with her skills and diligence, **Sven Kratz** for his survival packages of American sweets, **Emanuel von Zezschwitz** for spreading the good vibes, **Alina Hang** for being the kindest person, also in tough times, **Sebastian Löhmann** for the anecdotes about his friend Don, support during teaching and for keeping the hardware lab up and running, **Dominikus Baur** for being a perfect partner when exchanging ideas and critical thoughts, **Sebastian Boring** for sharing his passion for research, sports and the good things in life, **Fabian Hennecke** for always having jokes, football anecdotes and bike stories at hand, **Aurelien Tabard** for offering help and providing feedback, **Ronald Ecker** for inspiring evening discussions on research and life, **Martin Knobel** for bringing UX into my activities and **Heiko Drewes** for introducing me to the community. Thank you guys, you've made this place special!

Furthermore, I would like to thank **Anita Szasz** and **Franziska Schwamb** for helping me with all the bureaucratic processes the university has to offer, but even more, for all those nice conversations during coffee breaks in the kitchen.

Also I would like to thank all of my talented students who made this work possible and contributed with their attitudes and skills to get things done.

Finally I would like to thank my family for their support and patience to make this work possible. **Katja**, you deserve the biggest praise because you took the pressure off of my shoulders and gave me the freedom to pursue my goals. **Finn**, thank you for always reminding me of the most important things in life and for keeping me grounded.

Table of Contents

I Introduction and Motivation	1
1. Introduction	2
1.1 Context	3
1.2 Approach and Audience	7
1.3 Benefits and Goals	9
1.4 Overview	10
1.5 Contributions	11
1.6 Evaluation	12
1.7 Limitations	13

II. Related Work and Classification	15
2.Related Work	16
2.1 Tangible Interactions	17
2.2 Intangible Interactions	20
2.3 Summary	22
2.4 Design Processes	23
2.5 Design Process Methodologies	23
2.6 Prototyping	29
2.6.1 Low-Fidelity Methods	32
2.6.2 Mixed-Fidelity Methods	36
2.7 Summary and Discussion	41
3. Observations in Current Design Practice	42
3.1 Observations From an University Workshop	43
3.1.1 Setup	43
3.1.2 Findings	44
3.1.3 Summary	46
3.2 Field Study on Current Interaction Design Practice	47
3.2.1 Setup	47
3.2.1 Findings	48
3.3 Summary of Findings	50
4. Classification	51
4.1 Fidelity and Resolution	52
4.2 Number of simultaneous users	52
4.3 Spatial Dimensions	52
4.4 Engineering Expertise	53
4.5 Process Stage	53
4.6 Classification Visualization	54

III. Prototyping Tangible Interactions	55
5. A Prototyping Toolkit for Design Research	57
5.1 Design Research on Hybrid Interactions	58
5.2 Sketching with Objects	58
5.2.1 Components	59
5.3 Industrial Case Study	61
5.4 1st Set of Interviews at the Museum	62
5.4.1 Participants and Setup	62
5.4.2 Data and Analysis	63
5.4.3 Preliminary Findings	63
5.5 Brainstorming and Prototyping Session	64
5.5.1 Findings of the Brainstorming Session	65
5.5.2 Design Concepts	66
5.6 2nd Set of Interviews at the Museum	67
5.6.1 Participants and Setup	67
5.6.2 Data and Analysis	68
5.6.3 Findings	68
5.6.4 Drawn Design Conclusions	70
5.7 Summary and Contribution	70
6. Prototyping Tangible Interactions on Interactive Surfaces	73
6.1 Challenges Designing Tangible Interactions	73
6.2 Physical Objects on Vision Based Surfaces	76
6.3 Exploratory Study I	78
6.3.1 Participants and Setup	78
6.3.2 Data and Analysis	79
6.3.3 Findings of the Brainstorming Session	79
6.4 Exploratory Study II	81
6.4.1 Participants and Setup	81
6.4.1 Data and Analysis	83
6.4.2 Findings	83
6.5 Summary	85

6.6 Physical Objects on Capacitive Surfaces	88
6.6.1 Tracking	89
6.6.2 Creating Tangibles	90
6.6.3 Coding	92
6.6.4 Benefits of Sketch-a-TUI	92
6.6.5 Experiences	93
6.6.6 Limitations	94
6.6.7 Extensions	95
6.7 Industrial Use Case	95
6.7.1 Context	95
6.8 Expert Interviews I	96
6.8.1 Setup and Participants	96
6.8.2 Data and Analysis	97
6.8.1 Findings	97
6.8.2 Summary	101
6.9 Usability Inspection	102
6.9.1 Data and Analysis	103
6.9.2 Findings	103
6.9.3 Summary	107
6.10 Sketch-a-TUI Application	108
6.10.1 Technical Details	108
6.10.2 Application Features	109
6.11 Expert Interviews II	110
6.11.1 Goals	110
6.11.2 Setup and Participants	110
6.11.3 Data and Analysis	111
6.11.1 Findings	111
6.12 Summary and Contribution	113

IV. Prototyping In-Tangible Interactions	117
7. Prototyping Touch-less Interactions	119
7.1 Advantages and Challenges of Touch-less Interaction.....	120
7.1.1 Advantages	120
7.1.2 Challenges	121
7.2 Industrial Case Study	122
7.3 User Research	123
7.3.1 Setup and Participants	123
7.3.1 Data and Analysis	123
7.3.2 Findings	124
7.4 Scenarios, Interface Concepts & Expert Review	125
7.4.1 Scenarios	125
7.4.1 Interface Concepts	125
7.4.2 Expert Review	126
7.5 Using Open Soft- and Hardware Components	129
7.6 Experience Prototyping & Evaluation	131
7.7 Exploratory Pre-Study	131
7.7.1 Setup and Participants	131
7.7.2 Data and Analysis	132
7.7.3 Preliminary Findings	132
7.8 Immediate Usability Evaluation	133
7.8.1 Setup and Participants	134
7.8.2 Data and Analysis	135
7.8.3 Quantitative Results	135
7.8.4 Qualitative Results	137
7.9 Discussion	139
7.10 Summary and Contribution	139

8. Prototyping Remote Interactions	142
8.1 Context	142
8.2 Challenges	144
8.2.1 Physical properties	145
8.2.2 Prototyping	146
8.2.3 Study Methods	147
8.3 Evaluating Remote Interactions	149
8.3.1 UX Methods	149
8.3.2 Designing a remote interaction system	151
8.4 User Research	152
8.5 Low-Fidelity Prototyping	153
8.5.1 Concepts	153
8.5.2 Paper Prototyping	153
8.6 Lightbox	155
8.7 High-fidelity Prototyping	157
8.8 User Study I	158
8.8.1 Setup	158
8.8.2 Preliminary results	159
8.9 User Study II	160
8.9.1 Setup	160
8.9.2 Preliminary results	161
8.10 Discussion of Findings	162
8.11 Summary and Contributions	163

V. Discussion, Conclusion and Future Work	167
9. Discussion and Conclusion	168
9.1 Summary of the Process.....	168
9.2 Summary of Findings.....	173
9.3 Remarks on Methodology.....	176
9.4 Additional Challenges in Interaction Design.....	178
9.5 Ongoing and Future Work	179
9.5.1 Supportive toolkits	179
9.5.2 Evaluation	179
9.5.3 Future Work	180
9.6 Closing Remarks.....	181

List of Figures

1. Examples of high-fidelity prototypes	4
2. Interaction design process	5
3. TUIs in different contexts	7
4. Extending interaction design processes	8
5. Examples of TUIs	18
6. Intangible interactions	20
7. Sketches as continua	26
8. The design funnel	27
9. Framework by Houde and Hill	29
10. Inspiration Cards	32
11. Balsamiq Mockups	34
12. Tech Box	35
13. Mixed-fidelity prototyping	36
14. reactTIVision and the Reactable	37
15. Arduino LilyPad	38
16. Phidgets	39
17. University workshop	43
18. Visual representation of parameters	54
19. Sketching with Objects	59
20. Using Sketching with Objects	60
21. Extended user-centered design process	62
22. Impressions of a brainstorming	64
23. Initial ideas for UIs.....	66
24. Low-fidelity elements	67
25. Classification for Sketching with Objects	72
26. Practical use of TUIs	74
27. Geometrical forms	75
28. Pepakura	76
29. Initial version of Paperbox	77
30. Paperbox as process extension	77
31. Brainstorming on form factors for TUIs	79
32. Results from brainstorming with Paperbox	81

33. Results of the initial study	81
34. Designing with Paperbox	82
35. Classification of Paperbox	86
36. Sketching conductive ink	88
37. Schematic overview of Sketch-a-TUI	89
38. Templates of paper objects	90
39. Spatial configurations of conductive areas	91
40. Sketch-A-TUI prototype	94
41. Results of Likert scale questionnaire	98
42. Prototypes on three fidelity levels	102
43. Results of an explorative usability study	104
44. Study results and response frequencies I	105
45. Study results and response frequencies II	106
46. Study results and response frequencies III	106
47. Minimum/maximum distances	108
48. iPad application Sketch-a-TUI	109
49. Classification of Sketch-a-TUI	115
50. High-fidelity prototype Zwop	122
51. User research	124
52. Interaction concept for a touch-less interface	126
53. Intangible interaction concepts	128
54. Design process extension of using (open) soft- and hardware.....	129
55. Schematic overview of soft- and hardware components	130
56. Capacitive sensing layer	134
57. Results: task completion time	135
58. Results: area changes	136
59. Results: target-based interactions	136
60. Results: errors (false area interactions)	137
61. Response frequencies I	138
62. Response frequencies II	138
63. Visual classification of (open) soft- and hardware components.....	140
64. Light emitting media façades	143
65. Remote interaction system	148
66. Lightbox as design process extension.....	151

67. Paper prototypes	154
68. Pre-testing design concepts using Lightbox	155
69. Users interacting on the façade	157
70. Confirmed needs	161
71. Classification for Lightbox	164
72. Examples of toolkits	169
73. Implemented Design Process Extensions	169
74. Overview of disciplines	174
75. Creation of additional toolkits	175
76. Overview of CHI publications	176

I.

Introduction and Motivation

One could describe Design as a plan for arranging elements to accomplish a particular purpose.

Charles Eames

1. Introduction

In this thesis, we share our experiences of supporting interaction design processes by using toolkits as a means of prototyping *hybrid interactions*. These toolkits were intended to be both time and cost efficient as well as accessible to a wide audience of users. The initial section of this chapter will describe the context and underlying theoretical framework we used as a basis for our implementations. The bulk of the chapter is devoted to the benefits of our approach and a detailed overview of this thesis. In the final section of the chapter we share a summarized account of the contributions and limitations of our approach.

1.1 Context

“Machines that fit the human environment, instead of forcing humans to enter theirs, will make a computer as refreshing to use as a walk in the woods.” The closing remarks of Mark Weiser's essay on ubiquitous computing, written 20 years ago, describe a goal that is still desirable (Weiser, M., 1991). Most of the uses described by Weiser, the enhancement of leisure and work environments through Wi-Fi enabled tablet devices, for example, are now considered standard in our everyday lives.

However, the design space for electronic devices that Weiser envisioned, based on interactions that migrate away from traditional graphical user interface (GUI) models, is still evolving. Until today those concepts were considered as *science technology* rather than an aspect of a formal design process. These extended computing scenarios are commonly categorized in the human-computer interaction (HCI) community under the umbrella term *hybrid (mixed physical/digital) interactions*. Using this term, we define interaction forms to include, for example, *graspable* or *spatially separated* interface components along with those interaction forms that are not necessarily limited by the boundaries of a screen (see Figure 1).

This terminology is also associated with a *tight coupling* of interface components, which can be considered in different contexts and cases:

- (1) Feiner and Shamash (Feiner and Shamash, 1991), discussed the terminology of *hybrid interactions* as augmenting the physical space with digital objects, and coined much of the definition that exists today.
- (2) On digital surfaces, Rekimoto and Saitoh (Rekimoto and Saitoh, 1999) extended the interaction boundaries using physical objects and ubiquitous displays, which they described as “hybrid computing environments.”
- (3) The works of Fitzmaurice et al. (Fitzmaurice et al., 1995) examined the use of tangible user interfaces (TUI) and established the theoretical framework for *graspable interactions*, which bridge digital and physical worlds (Fitzmaurice, 1996) with “bits and atoms” (Ishii and Ullmer, 1997). Ullmer et al. took this theoretical framework to an application level with the MetaDesk (Ullmer and Ishii, 1997). In this case study, the authors explored how physical interaction models can be applied in use-cases and how the two dimensional *mapping* of GUI interface metaphors can be transferred to the physical space.

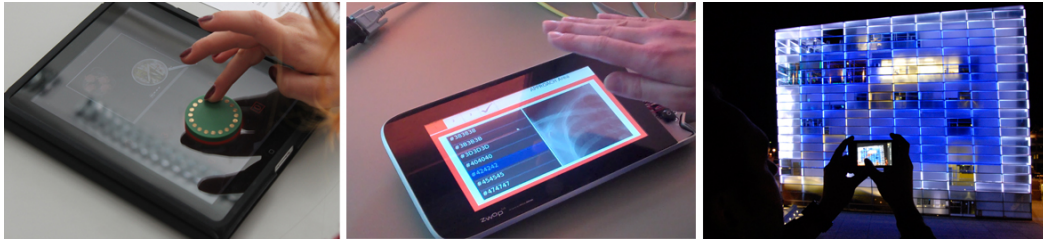

Figure 1. Three examples of high-fidelity prototypes exemplified in this thesis, which incorporates hybrid interactions (from left): Tangible user interfaces (TUI) on capacitive sensing devices, in-tangible touch-less interactions and remote interactions systems.¹

- (4) In-tangible interactions, such as those presented by Bolt (Bolt, 1980), are interfaces that include free-hand gesture or remote interaction forms. In this vein, Boring et al. (Boring et al., 2010), investigated interactions at-a-distance between large, public, non-reachable displays and mobile devices using one such interaction concept.

In this thesis we will use the terminology of hybrid interactions as included in the contexts and cases 1-4. The outcome of such interaction forms, as previously discussed, is generally manifested through interactive high-fidelity prototypes (see Figure 1). Our research asks how to systemically build these systems through iterative prototyping, including those used by lower fidelities.

As with any interactive product, a usable and effective result can be achieved by following a structured process within a particular design context. Interaction designers (Moggridge, 2006), (Saffer, 2009) and HCI researchers (Sharp et al., 2007) have described the design process phases as depicted in Figure 2, especially in the context of developing electronic products or services:

- The first phase is *key data collection*, and includes (a) extensive web and desk research of reference literature, as discussed by Shneiderman (Shneiderman, 2000), to gain insights into the design context and (b) the planning of subsequent process steps (Maguire, 2001).
- During the *user research phase*, as illustrated by Kuniavsky (Kuniavsky, 2003), field investigations concerning users' needs and aspirations for new technological solutions are undertaken.

¹ Photos (from left) © Hanna Schneider, Alexander Wiethoff and Martin Knobel

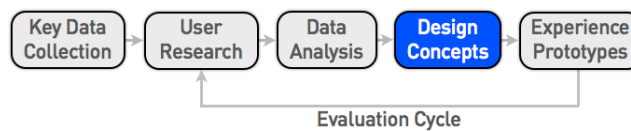

Figure 2. An example of a typical interaction design process used in research and industrial contexts, particularly in developing new products or services (Moggridge, 2006), (Saffer, 2009).

- In the *data analysis phase*, the insights of the two previous phases are extracted and filtered, using visual tools such as *affinity diagrams* (Beyer and Holtzblatt, 1999) or *blueprints* (Bitner et al., 2008).
- Those findings are then turned into concepts and scenarios in the fourth phase (Buxton, 2007), (Carroll, 1995), (Carroll, 2000).
- The most promising ideas are then built, using prototypes on both low and high-fidelity platforms (Houde and Hill, 1997) as a means of evaluation in coordination with users and of performing various design iterations towards a usable and satisfying result (see Figure 2).

There are various views on existing design approaches, particularly those considering different process models and methods. Jones, for example, provided an overview of 35 different methods, each designed for different contexts and purposes (Jones, 1992). In this thesis we will refer to the process modeled in Figure 2 as a reference for designing hybrid interactions. Strategic models of conceptual design, such as the one depicted in Figure 2, also reflect earlier pattern approaches. Polya's four phases of action solving for a particular (design) problem (Polya, 2004), initially introduced in 1957, get to the core of the matter in a more straightforward format:

- (1) Understanding the problem.
- (2) Devising a plan.
- (3) Carrying out the plan.
- (4) Looking back.

The first phase of this action plan corresponds to the previously introduced *user research phase*, while the second phase is related to the conceptual design phases *data analysis* and *design concepts*.

The third step, *carrying out the plan*, can be matched with the creation of *experience prototypes*, which directly addresses the identified problem with a solution. The fourth point resembles the *evaluation cycle*, in which the insights gained through the performance of the created prototypes, in coordination with users, can be retrospectively interpreted.

However, applying strategic design models while creating *hybrid interactions* bears its share of challenges. In particular, the obstacles posed by the *experience prototyping* phase are rooted in the lack of formally established guidelines on how to design *hybrid interactions* from scratch. Low-fidelity prototyping techniques for the development of regular GUIs are suitable prototyping tools for performing more design iterations and thus *getting it right* (Buxton, 2007). Paper prototyping (Snyder, 2003), for example, is used as a common method to explore early graphical interface concepts and filter out usability issues. These low-fidelity methods work because they do not confront the user with unnecessary design elements that would provoke unwanted feedback during the early stages of development. However, as Akaoka et al. (Akaoka et al., 2010) summarized when translated into the context of prototype creation with mixed digital/physical, hereafter known as as ‘hybrid’, interfaces in early stages, these methods do not support the opportunity to explore insights into users' experiences. In practice, the development of these systems often suffers from a divide between the exploration of form or embodiment and the interactivity itself (Avrahami and Hudson, 2002).

In summary, the challenges posed by prototyping hybrid interactions for low and high-fidelities include:

- (1) Even a small amount of interactivity is required to successfully explore these interaction forms in the early stages of development.
- (2) There is very little reference guidance or literature on how to prototype these systems in an ever-evolving design and opportunity space.
- (3) A substantial amount of engineering expertise is still required to create interactive prototypes of hybrid interactions during the design process, both on high and low-fidelity platforms.

As a result of these circumstances, designers face a number of limitations in this domain. The development and repeated use of these interaction technologies is limited, which in turn hinders their further development. For example, the domain of tangible interaction (see Figure 3) has been struggling for two decades to find a unified language for semantics.



Figure 3. Use cases of TUIs in different contexts (from left): SandScapes (Ishii, 2008), a project to explore elevation levels physically, AudioPad (Patten et al., 2002), a musical device and the digital/physical work-bench URP, a tool intended to help city planners (Underkoffler and Ishii, 1999).²

This issue may result from sparsely distributed use-cases. Similarly, Greenberg (Greenberg, 2006) refers to Gaines' BRETAM model (Gaines, 1991) pertaining to the development of *science technology*, in his article on supportive toolkits which claims that for the successful establishment of any *science technology*, replication has to be supported. Through constant replication, the ideas of others can be mimicked, the original creative impulse can be tweaked, resulting in new ideas which in turn support the establishment of *science technology* like the one described in this thesis.

To address these challenges, we considered appropriate methods for iteratively building these systems on both low and high-fidelity prototypes. As a result, we argue that there is an opportunity space for assistive toolkits (Beaudouin-Lafon and Mackay, 2011) that will support replication and help compensate for the aforementioned limitations.

1.2 Approach and Audience

Supportive toolkits have the ability to positively influence the design process: Shneiderman (Shneiderman, 2000) refers to tools used to support the creation of innovative concepts as “**what-if-tools**” that are intended to support the creation of new, innovative concepts while making them quick, efficient, and explorable. In his GENEX (Generation of Excellence) framework, Shneiderman describes the generation of new, creative concepts in four steps. The third step, “Create: explore, compose, and evaluate possible solutions,” claims the importance of tools, supporting creativity in the design process.

² Photos (from left) © Amber Case, Aaron Tang, Sabine Starmayr. Reproduced under a CC BY-NC-ND 2.0 License <http://creativecommons.org/licenses/by-nc-nd/2.0/deed.en>

The fourth step, “Donate: disseminate the results and contribute to the libraries,” states that for the successful establishment of these tools, the results need to be accessible so the community can assist with their further evolution (Shneiderman, 2000).

Like Shneiderman, we believe in a design approach that supports the primacy of doing (working the concept through) as the main characteristic. Through the iterative evolution of an idea and consecutive phases, namely a prototype, the final design can be crafted and shaped towards a usable and enjoyable result (Buxton, 2007). By using our implementations, we want to support the creation of innovative concepts that allow designers to *reflect-in-action* (Schön, 1987). To do this we remove low-level implementation burdens for creating prototypes in this domain and **provide building blocks** (Greenberg, 2006) to allow designers to concentrate on creative designs. Through the dissemination of our research we want to support the further evolution of these tools “that allow one to quickly try out a variety of scenarios” (Shneiderman, 2000) and so enable more design iterations during this process. Furthermore, our implementations serve as catalyst for design teams in which they act as **mediums of communication**.

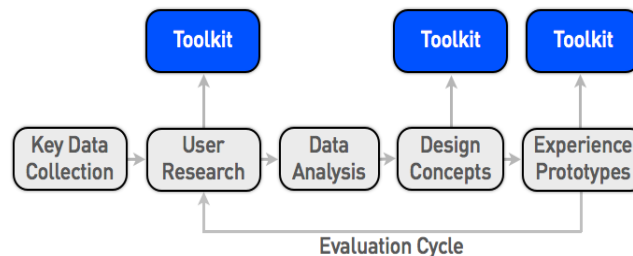

Figure 4. Our approach extending interaction design processes in specific phases with additional auxiliary means in the form of toolkits.

In summary, we will support the design process of *hybrid interactions* by **extending interaction design processes** (see Figure 4) in specific phases (namely user research, creating design concepts and prototyping) with toolkits that support the ideation, design and pre-testing of hybrid interactions.

Our audience is designers or design teams that have some technical experience, but limited hardware or electronics expertise. Based on our own investigations (as discussed in a later section), and experiences in the field, we have noticed that in all design studios we observed, there was still limited tech-support available

during prototype creation of *hybrid interactions* that were both fast and cost effective. As a result, the implementation of interactive prototypes was frequently handed off to specialists, which leads to gaps and delays in the design process. Consequently, only a limited number of design concepts could practically be explored through interactive versions, which limited the number of explored design concepts. This matter can become an issue when designing novel interactive systems; without iterative early prototyping, it is far too easy to produce poor designs. Using our implementations, we want to empower designers to conduct prototyping in this challenging context by themselves, and thus perform more iterations, or as Buxton stated, “get the right design and then get the design right.” (Tohidi et al., 2006), (Buxton, 2007) Shneiderman, (Shneiderman, 2000) also recounted the advantage of having assistive tools in the design process in that they “support more creativity by more people more of the time.”

The amount of previous technological knowledge required by designers in using our toolkits varies and is therefore discussed in a later section.

1.3 Benefits and Goals

The created toolkits serve as supportive enablers in both creation and exploration for a variety of design ideas during the early stages of the design process. They support the creative process of concept generation as well as the creation of prototypes in the realm of hybrid interactions. Within multidisciplinary design teams, our toolkits are able to **provide focus** within a very large design space. Additionally, they act as communication mediums, able to glean various opinions during conceptual design sessions. As a result, they allow teams to think creatively on an application level without spending too much time on low level implementation issues. Instead, they are invited to test and try ideas that are both time and cost efficient. Thus, they create momentum in the design process that is sustained by accelerating the development of a variety of design solutions.

The dissemination of the toolkits within the scientific community can support the reproduction of novel systems. This can lead to the increased distribution of applications in this domain, which in turn aids in establishing novel and emerging technologies.

In summary, the benefits of using a design process such as the one described in this work include:

- (1) Enhanced interdisciplinary team communication.
- (2) Time- and cost-effective methods that potentially speed up the design process, e.g., more design iterations can be performed in a shorter time-frame.

Goals

By providing this thesis we intend to pursue the following goals:

- **Create** alternative auxiliary means for prototyping hybrid interactions more effectively and use field studies on current interaction design practices to reveal insights into the methods and obstacles encountered by interdisciplinary teams.
- **Reveal** insights into the suitability of our approach through formal experiments, informal explorations, and studies of our implementations in industrial design contexts.
- **Apply** suitable evaluation methods for this context through experimental use and adaptation of relevant practices.
- **Share** our approach with the community. Through the dissemination of our research in the form of publications, blogs, code, and clear instructions for replication we make our approach available to others.

1.4 Overview

This thesis is structured in six main chapters containing various subsections. The **introduction** covers the big picture of this thesis in a holistic view (*zoomed out*). Here, we reflect on the context, benefits and limitations of our approach. In the **second chapter** (Related Work), we reflect on design processes and practices in general and compare prototyping toolkits on different fidelity levels with our approach in detail (*zoomed in*). In the last part of the second chapter we share our experiences investigating an interdisciplinary university workshop with the goal of creating prototypes for hybrid interactions. We then compare our findings with a field research study of large design studios, considering current interactive design practices in industrial contexts and the opportunity space for assistive toolkits. The **third chapter** provides the lessons we learned in prototyping tangible interactions using our approach. We introduce our toolkits to an industrial use-case and share observations on how a team of industrial designers

experienced our toolkit during the design process of a new product for their portfolio.

The **fourth chapter** presents results from example case studies in the area of intangible interactions. We provide a case study of two industrial projects with different objectives. The first project reflects the design process of prototyping a touch-less gesture-operated device for medical purposes. The second project includes a remote interaction system used for interacting with a large media façade. The **final chapter** is devoted to a critical, retrospective discussion of our chosen approach. We discuss our approach's advantages and limitations and how these shortcomings can be improved. In this chapter we switch again to a holistic perspective (*zoomed out*), reflect on our experiences in conjunction with the experiments, and discuss the implications of our conclusions for future implementations.

This thesis provides short introductory abstracts at the beginning of each chapter to let the reader quickly jump into specific sections directly. In the running text we use **bold** font types to emphasize a point or mark a phrase to remember. We use *italic* print for calling attention to *special concepts* and *terminology*. Additional visual guidance is provided by a simple illustration at the bottom of the page:



Tangible UIs



In-tangible UIs

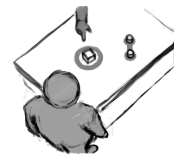

Design Process

1.5 Contributions

Using the previously presented approach, we conducted several research projects with a practical objective related to an industrial context. Developing these systems we used our tools to support the interaction design process.

In summary, we consider the following contributions:

- (1) We **created toolkits** that others can replicate and use in their work. Our approach allows the integration of these auxiliary means with standard interaction design processes and provides extensions as starting points. They serve as a means of helping design teams work through their ideas

in a practical manner compared to a theoretical process model. Others can replicate and re-apply our implementations through the provided instructions and guidelines.

- (2) In coordination with our industrial partners, **we shared the lessons we learned** by exposing our implementations to situations and design challenges *in the wild*. By applying our toolkits in real contexts, (i.e., designers creating new products) we were able to ascertain exactly how our approach was utilized in an industrial context and how it assisted design teams that were confronted with domain specific challenges.

1.6 Evaluation

All of the work in these presented studies was conducted out of the lab in real-life contexts. Doing so resulted in a variety of new challenges to be considered, especially when compared to lab environments, as many independent variables could not be fully controlled. In addition, we were investigating the processes of prototyping interactive systems, not creating products or refined (final) prototypes. We therefore created an appropriate study design for each individual context in which we used our toolkits.

We used methods that investigated different aspects of our implementations, which were then adapted to individual cases:

- HCI methods (Lazar et al., 2009), (e.g., investigating usability and performance).
- Qualitative techniques (Corbin and Strauss, 2008), (e.g., observational techniques, semi-structured interviews, diary studies).
- User experience (UX) methods (Bargas-Avila and Hornbaek, 2011), (e.g., psychological design requirements).

We used these methods in a combination or alone, depending on which related best to the context. In one case, for example, investigating the usability of a system was a mandatory base-line for a positive result, and thus, we went about the evaluation of user experiences through a consecutive study phase. In addition, we used qualitative research methods as tools for investigating pertinent observations during the design process for the creation of the system.

1.7 Limitations

Our approach has its limitations:

- (1) The toolkits consist of predefined elements, so there is a tradeoff in terms of their **flexibility**. There is of course also the danger that these supportive tools may potentially hinder creativity (Shneiderman, 2000). On the other hand, having a tool to begin working with can compensate for this limitation as it provides an advantageous focus within a very large design space.
- (2) We provide exemplary toolkits only for **specific cases**. However, this limitation provides fertile ground for future work as we believe that a *shelf of prototyping tools*, as discussed in this work, can enrich a designers' work environment in which novel interaction forms are envisioned and created.

II.

Related Work and Classification

If history is any indication, we should assume that any technology that is going to have a significant impact over the next 10 years is already 10 years old!

Bill Buxton

2. Related Work

The first part of this chapter provides a definition of hybrid interaction forms and makes a distinction between them and regular, GUI-based interaction devices. Furthermore, we provide example projects within the field of tangible and intangible interaction systems as a reference-point for the hybrid interactions of which design process we aimed at improving. The second part of this chapter is devoted to a comparison of design processes in interaction design, HCI, and software development. The third part of this chapter presents a deeper introduction to prototyping tools and techniques for both fidelities and how they differ in comparison with our implementations. The final section is dedicated to a short summary and discussion of what the previously discussed works mean for our own implementations.

2.1 Tangible Interactions

Douglas Engelbart presented a game-changing demo on how the human intellect can be enhanced through technology at the Fall Joint Computer Conference, held in San Francisco, 1968. Far ahead of his time, he described how technology can empower people to accomplish tasks faster, more accurately and reproduce their results (Engelbart and English, 1968). To demonstrate these then hoped-for technologies, he presented a variety of interactive prototypes: a conferencing system, a physical input device for manipulating digital objects and a mixed reality overlay between video images and computer generated content. In the underlying theoretical framework, initially authored in 1962, Engelbart argued that these *electronic artifacts* can enhance human abilities to interact with computers (Engelbart, 2001). Far from the modern goal of ubiquitous technology accessible to a wide audience, Engelbart envisioned users who would be technological experts; they would undergo a specialized training before operating the presented devices. Ironically, his concept for the *mouse* is now considered to be one of the most important drivers of the effort to make *science technology* (a technology form which is being explored in research labs but has not hit the consumer market yet) accessible to a wider audience, including novice users.

Like Engelbart, Ishii stated in his overview article on the evolution of TUIs (Ishii, 2008a), that tangible interaction forms can support the human intellect by addressing additional interaction channels (see Figure 3 & 5). Compared to TUI interaction, the electronic artifacts Engelbart described in his framework, the mouse and keyboard, do not fit the concept of a *tight coupling* between physical artifacts and digital representations; rather, they employ a very generic way of manipulating digital media (Ishii, 2008a). The same de-coupling of interactive elements also applies to early concepts of alternative input devices, such as those realized in the work Sutherland conducted in 1963 (Sutherland, 1964). His application *Sketch-Pad* consisted of a generic physical object (i.e., a light pen) that allowed direct manipulation of varying digital content on a graphical screen.

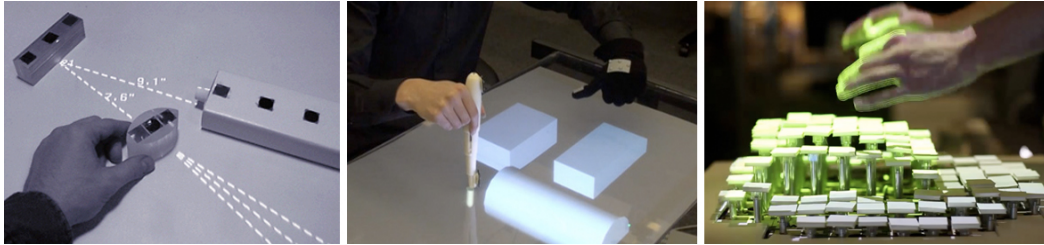

Figure 5. Examples of TUIs (from left) using static objects by (Underkoffler and Ishii, 1998), more flexible dynamic, shape changing interactions (Lee and Ishii, 2010) and reactive objects (Leithinger et al., 2011).³

However, Ishii described a *tight coupling* of the physical representation of digital information as a key attribute for TUIs (Ishii, 2008a), taking advantage of haptic interaction skills, or as Blackwell and Edge put it, “[offering] a further opportunity for cognitive efficiency that is not supported by the surface markings of diagrams and GUIs” (Blackwell and Edge, 2009).

Research conducted on this topic in the last two decades investigated these relationships and provided insights into how physical representations of digital information could look and be used in work or leisure environments (Shaer and Hornecker, 2010). Practical examples include tools for designing with light such as the one depicted in Figure 5, left. In this application, physical objects provide the interface artifact while the digital representation explains the behavior of the objects (here laser, mirror, and prism). Another way of manipulating digital objects considers shape-changing objects that provide an opportunity to *grasp* and *manipulate* digital objects (see Figure 5, middle). In a more recent approach, researchers explored ways of providing physical interfaces that can also change their shape and provide alternative feedback through spatial arrangement (see Figure 5, right).

An early idea sketch using a TUI was presented in 1992 by Durell Bishop with his Marble Answering Machine (Crampton Smith, 1995). Digital information (voice messages) was directly coupled to physical objects (marbles). He envisioned that, once an object was placed onto a specified zone, the replay of the associated voice messages was triggered. This close coupling gave everyday objects new meaning and linked them directly to digitally stored information. In that sense the sketch contributed to Weiser's vision of integrating computers with

³ Photos © by the referenced authors



arbitrary objects (Weiser, M., 1991) and making the interaction with computers invisible (Weiser and Brown, 1996).

In a more recent approach, Cheng et al. applied the coupling of arbitrary everyday objects into controllers for digital content on interactive surfaces (Cheng et al., 2010). In our research, we investigated the design process for TUIs on interactive, digital surfaces. Fitzmaurice et al. laid the conceptual foundations for these interaction forms (Fitzmaurice et al., 1995): in their case studies, three dimensional (3D) objects served as physical *handles* closely *tied* to the manipulation of digital information. When the input was performed through the physical manipulation of specific objects, the result was illustrated via a digital graphical output. On an application level, the early works on tangible interactions by Underkoffler and Ishii (Underkoffler and Ishii, 1999) exemplified the use of static objects as controllers for digital content. Their urban planning bench (URP) presents an implementation for the use of tangible interaction forms in an urban planning scenario (see Figure 3, right).

Ullmer and Ishii illustrated within the MetaDesk framework (Ullmer and Ishii, 1997) how the *mapping* of GUI widgetery could be transferred into physical space. For familiar instantiations in GUI environments, such as *windows*, *icons*, or *menus* they created new physical 3D instances such as a *lens*, *phicon* (physical icon) or *tray*. In a following project Rekimoto et al. (Rekimoto et al., 2001) explored how such physical *lenses* can act as controllers for widgets, embedded in transparent tiles. These concepts were then taken ahead in more recent works by Ullmer et al. (Ullmer et al., 2010), (Ullmer et al., 2011), providing a framework for tangible interactions throughout distributed computing systems.

Tangible interaction (Ishii, 2008b) also bears clear limitations: as these tangible UIs consist of predefined elements that are closely coupled to digital information, they bear limitations in terms of their flexibility. When using rigid objects, this limitation quickly becomes evident as a particular object can only be used for a certain number of actions. Hence, more recent investigations in this research field have tried to overcome this difficulty by experimenting with flexible, shape-changing elements as presented by Lee and Ishii (Lee and Ishii, 2010) or Leithinger et al. (Leithinger et al., 2011). In addition, Reed explored clay as material for designing flexible TUIs, potentially including more functionality (Reed, 2009).

However, the design of these interaction forms still faces unsolved challenges (Kirk et al., 2009): the affordances that these interfaces provide (Norman, 1999) can often be misinterpreted or, even when correctly understood, can lead to a

misuse of the interface (Hornecker, 2012). Designers have to consider that the *tight coupling* of an physical interface with digital information demands careful consideration and early pre-testing in order to discover the appropriate *mapping* between the physical and digital worlds (Hornecker, 2012). These circumstances call for tools that allow one to test out a **variety of scenarios** with users early in the design process, through which the least promising design concepts can be filtered out before the final implementation (Lim et al., 2008).

2.2 Intangible Interactions

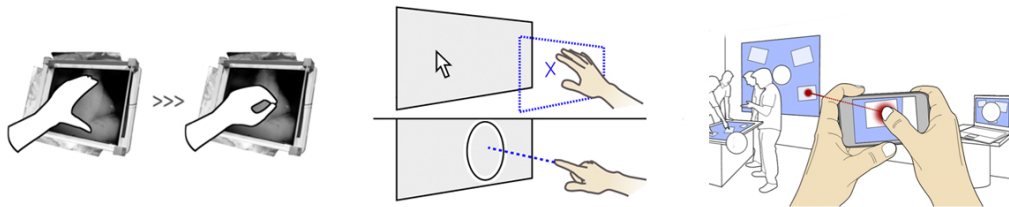

Figure 6. Conceptual models for intangible interactions in different cases (from left): Gestural interaction using electric field sensing (Wimmer et al., 2006), cursor control and selection on large screens using tracking (Vogel and Balakrishnan, 2005), and remote interactions with the support of a mobile device (Boring et al., 2010).⁴

As with tangible interaction, finding the appropriate *mapping* of an embodied representation or digital artifact is a challenging task when designing in-tangible interactions, as discussed by Bolt (Bolt, 1980). In this experimental setup a large screen was operated through voice recognition, free-hand gestures and remote control elements. Additionally, Krueger et al. (Krueger et al., 1985) presented a system that allowed full body interaction as an input mechanism.

The design challenges of finding an adequate dialogue between physical interaction and its digital result were discussed while creating a free-hand gesture operated control mechanism, as introduced by (Freeman and Weissman, 1995). In a more recent work, De la Barré et al. (de la Barré et al., 2009) exemplified possible use-cases for in-tangible (hybrid) interaction forms. Hinckley et al. (Hinckley et al., 1994) provided an initial overview of design issues with spatial interactions. In their conclusion, they highlighted the importance of users being able to understand spatial relationships and implemented metaphors: on one side

⁴ Photos © by the referenced authors

the technology needs to be able to safely detect a variety of patterns while on the other side the gestural vocabulary needs to be understood and easily memorized by the user (Freeman and Weissman, 1995).

Accidentally executed gestures bear additional design challenges in creating usable systems with these interaction forms. In a 3D space the gesture set can become incomprehensible if the visual guidance is missing.

The underlying sensing technology creates an additional constraint on the design space for these systems:

Electric field sensing has been utilized as one possible solution for tracking users' movements and gestures (Joshua et al., 1998). The same technology was used in creating the system introduced by Wimmer et al. (Wimmer et al., 2006), which enabled users to interact with content triggered through free hand gestures performed in front of the screen (see Figure 6, left). Capacitive sensors positioned in the four corners of the screen detected changes occurring in the electric field and thus allowed an accurate tracking of the users' hands or fingertip positions. These systems allowed spatially intangible interactions by tracking users' movements, effectively extending the interaction space in a third dimension. The limitations of this sensing technology are usually constrained by the spatial range of the utilized hardware.

Also accurate, but spatially more flexible, is the underlying sensing technology for capturing users' actions in a three dimensional context, or “tracking”, as demonstrated by Vogel and Balakrishnan (Vogel and Balakrishnan, 2005). Their setup allowed users to *point-and-click* via spatial interactions in front of large displays (see Figure 6, middle). Using tracking technology in conjunction with interactive surfaces, Hilliges et al. explored the third dimension as additional interaction space above tabletop computers (Hilliges et al., 2009). To aid users in connecting with the implemented *mapping* between gestural input and digital output, they added visual guidance via shadow tracing, and thus made the tracking of the users' actions visible on the screen. Using the same conceptual model, Shoemaker et al. (Shoemaker et al., 2007), exemplified how traced body shadows can provide additional guidance with intangible interactions and thus improve the usability of these interface concepts.

Intangible interactions can be more spatially separated than in previously discussed cases. Olsen and Nielsen (Olsen, Jr. and Nielsen, 2001) enabled interactions over large distances through laser pointing. Remote interactions with far away or *hard-to-reach* display types were the central aspect of the implementations presented by Boring et al. (Boring et al., 2010). In their work, they explored interaction forms *at-a-distance*. In one of their experimental

project setups the authors turned a mobile device into a *see through panel* that allowed direct interaction on distant displays using live video (see Figure 6, right).

2.3 Summary

In summary, all of the aforementioned examples of hybrid interaction computing systems have one aspect in common: finding the appropriate *mapping* between physical, gestural or remote input and digital output can become a challenging task. In this problem space, early pre-tests in coordination with users can aid the design process in finding the right format for both representation and content. Prototypes built on lower fidelities can serve as an appropriate means for gathering data on how design concepts are perceived and thus can help *get the design right* by performing a greater number of design iterations. Thus, our research question addressed the earliest starting point in the design process: prototyping these systems. How does one build early prototype applications for these interaction forms while performing a greater number of design iterations ? We provide extensions for interaction design processes and explored their practical use in case studies that involved projects incorporating tangible and intangible interaction forms.

2.4 Design Processes

In the first part of the following section we discuss why interaction design processes with strong user involvement are a suitable means for designing hybrid interactions. Next we discuss process methods in relationship with our own research. The remainder of this section is devoted to supportive toolkits on different fidelity levels and how they differ in relation to our own implementations.

Clarification: The following section discusses related work on design processes on an (a) holistic and (b) task-oriented level. In accordance with this section we consider the concept of *methodology* to be a way of design thinking, viewed from an holistic perspective (*zoomed out*). By referring to the term *method* we invoke a wide variety of *crafting design*, particularly within different process phases and through task-oriented practices on a detail level (*zoomed in*). Design methods can consist of instructions for tackling certain design contexts or, by additional means, assisting a team of designers by, for example, using toolkits.

2.5 Design Process Methodologies

In the past few decades, much literature has been published on interaction design processes and practices by both the design and scientific community (Sharp et al., 2007), (Moggridge, 2006), (Saffer, 2009), (Buxton, 2007). According to Sharp et al. (Sharp et al., 2007) interaction design processes can be summarized by three key characteristics: “...focus on users, iteration, and specific usability and user experience goals...” Related to these activities, the International Organization for Standardization (ISO) files the standard for human-centered design under the norm ISO 9241-210:2010 (Standardization, 2012). The main design activities described in this norm involve:

- (1) Understanding and specifying the context of use.
- (2) Specifying the user requirements.
- (3) Producing design solutions.
- (4) Evaluating the design.

These activities correspond closely to the process model presented in Figure 2. However, in terms of their description, they are more properly related to task-oriented design activities while the conceptual interaction design model presented in Figure 2 represents the process on a *higher level*.



Interaction design is considered an interdisciplinary area of expertise that overlaps with engineering and creative-design disciplines (Saffer, 2009). Hence, interaction design can be interpreted and practiced from many different professional perspectives (Vredenburg et al., 2002).

To make this interdisciplinary relationship more explicit, Löwgren illustrated a critical comparison between creative design and software engineering perspectives (Löwgren, 1995). He pointed out that interaction design processes within the creative design and the human-computer interaction (HCI) community (Dix, 2004), (Smith-Attakan, 2006) differ strongly from one another. He explained that creative design approaches are driven by a *problem setting* and *problem solving* attitude (Buxton, 1986) and that creative design processes can be characterized as being *unpredictable*, and *exploratory*, while allowing *various alternative design solutions* as final outcome. Similar to the characteristics Löwgren described, we wanted to address the design process of prototyping hybrid interactions in a way that would support the creation of various possible design solutions in early process stages.

On the other hand, Löwgren described software engineering processes as being *analytical, predictable* and achieving *one satisfying result*:

Engineering design “assumes that the 'problem' to be solved is comprehensively and precisely described, preferably in the form of a requirements specification. The mission ... is to find a solution. Engineering design work is ... seen as a chain of transformations from the abstract.” (Löwgren, 1995)

Quite on the contrary, Löwgren remarks that creative design work “is about understanding the problem as much as the resulting artifact ... In this interplay, the design space is explored through the creation of many parallel ideas and concepts.” (Löwgren, 1995)

According to Buxton (Buxton, 2007), Margolin and Buchanan (Margolin and Buchanan, 1995), and Wolf et al. (Wolf et al., 2006), interaction design methodologies are better situated when designing for “wicked” situations (Buxton, 2007) as understood by Rittel and Webber's definition (Rittel and Webber, 1984). They refer to “wicked” design situations characterized by “incomplete, contradictory, and changing requirements that are often difficult to recognize,” which is the case when designing systems that incorporate hybrid interactions.

Software engineering processes, in contrast, are still strongly tied to using requirements as starting points in the process, requirements that include “overall properties of the system, i.e. constraints on the systems emergent properties.” (Kotonya and Sommerville, 1998) Hence, software design processes are largely

driven by “showcasing solutions, evaluating opinions and agreeing on system properties.” (Moussette and Dore, 2010) However, in the early phases of the process, these properties and constraints remain unclear, particularly when designing systems to incorporate hybrid interactions. They are revealed in later phases, like the prototyping phase, when technological limitations occur or constraints in human abilities are revealed. Newer software design process models such as *Agile* (Martin, 2003) also consider iterative development approaches, but to a large extent they do not support exploratory or noncommittal activities, which are quite substantial when prototyping hybrid interactions.

On the other hand, these **noncommittal design activities** are suitable for exploring an unknown design space within a design process that is, to a large extent, coined by *trial-and-error* experiences. These experiences provide new insights and, through iteratively achieved improvements, lead towards a usable, useful and enjoyable result. Buxton discusses the characteristics of such a design process as including the ability to *fail early and fail often* (Buxton, 2007). Hence, an extended interaction design process, in which a variety of solutions are explored in parallel (Shneiderman, 2000), (Löwgren, 1995) allowing the least promising design concepts to be filtered out rapidly, appears to be the most appropriate context for our situation.

This assumption is supported by Van den Hoven et al. (van den Hoven et al., 2007), Buxton (Buxton, 2007) and König et al. (König et al., 2010) who agree that new forms of interactions also require new design process methods and developer tools. Fallman states that strategic design considerations such as *fieldwork*, *theory* and *evaluation* provide valuable input to a design process in this context but do not provide the necessary whole (Fallman, 2003). He suggests, as do other researchers, that members of the HCI community should consider the use of creative design tools as a valuable method for alternative design exploration (Fallman, 2003), (Zimmerman et al., 2007), (Frayling, 1993).

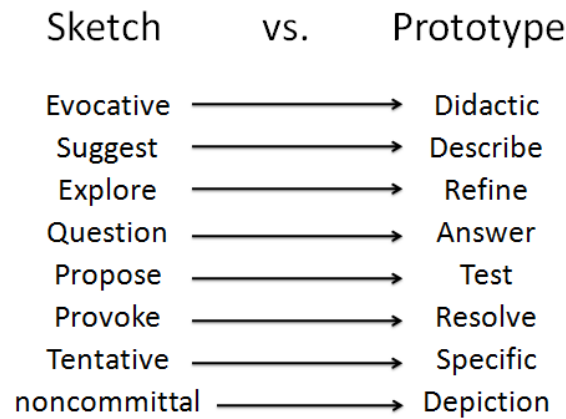

Figure 7. Sketches as continua and their evolution to prototypes with different purposes as understood by Buxton (Buxton, 2007).

Sketching is an activity that is used in creative design processes in early stages. It acts as a medium that allows designers to step into a creative *self-reflective dialogue* (Schön, 1992) and lets them explore a **variety of design concepts** in a visual manner (Buxton, 2007). Buxton does not limit the activity of sketching to pencil and sketchbook. Instead, he describes sketching as a playful activity supporting **dialogues on conceptual design**, including also the creation of mockups, to initiate reflective processes using alternative means. He distinguishes sketches from prototypes as being characterized by different key attributes, such as: *quick, timely, inexpensive, disposable, plentiful* and *ambiguous* (see Figure 7). We wanted to support the design process with tools that match these criteria, while providing enough interactivity to explore design concepts *in action*, using, for example, methods such as sketching in hardware (Holmquist, 2006).

We argue that designing hybrid interactions demands a design process that is shaped by *reflective action* and refining the concept by *working it through* rather than *thinking it through* as physical action and cognition are interconnected (Schön, 1983), (Klemmer et al., 2006), all of which stands out as an important characteristic of these interface types. Schön claims that successful product design results from a series of *reflective conversations* with materiality. He describes this design process as a *sequence of interactions* between the designer and the *sketching medium* (Schön, 1992).

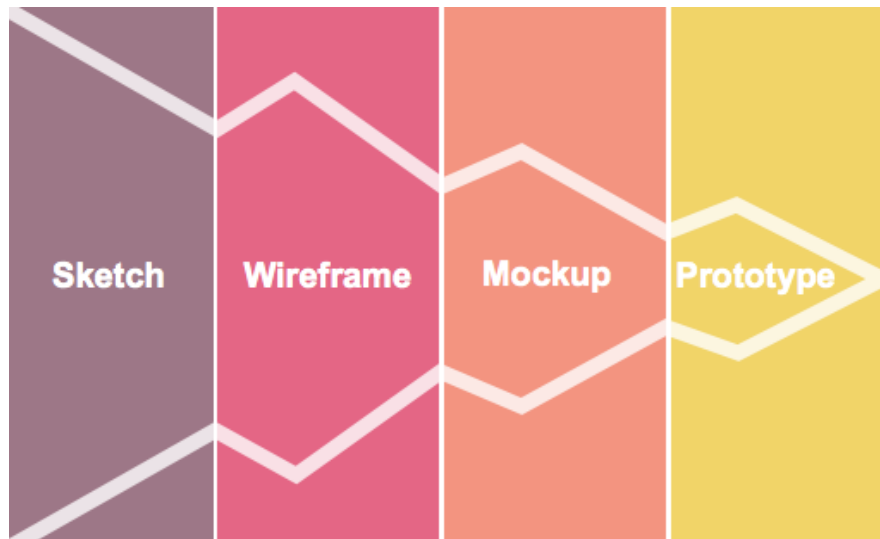

Figure 8. The design funnel illustrates the repetition of the elaboration/reduction cycle from low-fidelity to high fidelity, converging into the final concept (Buxton, 2007).

These interactions include shaping clay, building with foam-core, sketches on paper or real-size mockups made of everyday objects decoupled from their initial use. Transitions between sketches and prototypes are not set in stone (Buxton, 2007). Instead, Buxton considers sketches to be continua that evolve over time, and he claims that an increased fidelity of the sketches should match the phase of the design process accordingly. For example, during the early phases of the design process, working with sketches that are too visually refined can lead to confusion among the team members; many questions of the design concept remain unanswered, while the fidelity of the sketch communicates the opposite fact (Wong, 1992).

From this perspective, the funnel of innovation that Buxton described for the interaction design process illustrates that the boundaries between sketches and prototypes are essentially blurred (see Figure 7 & 8). Early sketches can serve as a medium, designing an interaction in conjunction with users to get early outside feedback (Tohidi et al., 2006b). As presented by Svanaes and Sealand (Svanaes and Sealand, 2004), through iterative refinement, these sketches can evolve and eventually provide the foundations for the design of a new interactive system. In their case study, they created artifacts during the design process that could be reused in later process stages while serving as a communication medium or a

way to make a complex interaction design relationship more *graspable*. This aspect of being able to quickly make a complex interaction model explicable was one motivation for creating our tools, as we believe that a strong internal and external sense of team communication coupled with constant user involvement is essential for a successful outcome.

User involvement during the interaction design process can be considered from different perspectives as well, as Sanders illustrated (Sanders, 2008). Her journal article on participatory design is an example of how an interaction design community considers users to be active team members in the design process (Sanders et al., 2010). Muller and Kuhn (Muller and Kuhn, 1993) presented a taxonomy for participatory design practice which, in the design process, depicts tools in relationship with user involvement. This circumstance is also a substantial point of discussion by Sanders (Sanders, 2008): she considered different mindsets that influence the design process in accordance with underlying professional motivations, either research or design driven. Sanders further expanded upon the users' role in the design process by considering these different angles: an interaction design oriented process driven by a participatory mindset would consider users to be *active co-creators*. On the other hand, an expert mindset thinks of users as *reactive informers*. We considered the users to be *active co-creators* in the early stages of the process, such as the *user research* phase, and as *reactive informers* in later stages of the design process, such as the *experience prototyping* phase. Additionally we used common participatory design process techniques such as *acting out* and *role playing* (Brandt and Grunnet, 2000), (Oulasvirta et al., 2003) as a means for communication with users in the early phases of the process.

2.6 Prototyping

Prototypes as design process artifacts are commonly used in the design and research community, representing manifestations of design ideas at different stages. They inform the process and aid in making design decisions (Buchenau and Suri, 2000). While representing different states of product evolution, prototypes can exist on different fidelity levels and serve different purposes in the design process (Lim et al., 2008), (Rudd et al., 1996). Low-fidelity prototypes are commonly used for early expressions of ideas, where they serve as a *reflective medium* (Schön, 1992) by triggering open discussions within a design team (Sefelin et al., 2003). High-fidelity prototypes, on the other hand, usually represent more concrete ideas, expressed earlier through low-fidelity artifacts, and intended to confirm the assumptions of the design team (Rettig, 1994). However, categorization that relies on exclusively low and high-fidelity creates too narrow a perspective on the nature and capabilities of prototypes (McCurdy et al., 2006), (Houde and Hill, 1997). In considering the idea that prototypes can represent a continuum between low-fidelity and high-fidelity, Houde and Hill (Houde and Hill, 1997) introduced *resolution* as an additional parameter.

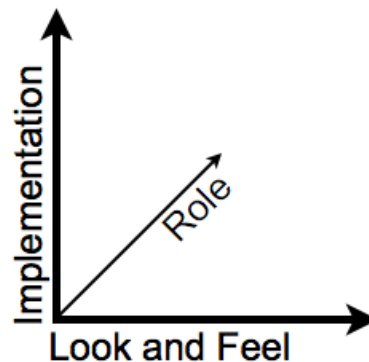

Figure 9. The framework by Houde and Hill. Designed for a more precise understanding of the capabilities of prototypes in the design process, it considers different dimensions such as *Role*, *Look and Feel* and *Implementation* (Houde and Hill, 1997).

Using this revised understanding, they can comprehend the amount of detail a prototype incorporates, while the extent of fidelity, from their perspective, represents “closeness to the eventual design” (Houde and Hill, 1997).

For example, a prototype for a new webmail client, intended for early testings with users, can consist of simple sketches (Löwgren, 2004) (low-fidelity) but incorporate a large amount of detail (high-resolution) regarding the envisioned functionality. On the other hand, a prototype for a new product line operated through an interactive touch display (high-fidelity), can be equipped with only limited available functions (low-resolution).

Different disciplines also have their own interpretation of the concept of the *prototype*. An industrial designer, for example, would probably refer to a clay model, while an engineer would consider a unique, specialized part for a new system (Houde and Hill, 1997). However, for digital, interactive artifacts, the purpose, i.e., how a prototype is used as a design process medium, differs strongly from these perspectives. Based on these circumstances, Houde and Hill (Houde and Hill, 1997) introduced a framework to assist designers towards a better understanding of the capabilities and properties of their prototype within a particular design context (see Figure 9). They proposed a triangulation of the different properties that prototypes can accommodate during the design process:

- (1) The property of *role* questions the *impact* the prototype will have in the users lives.
- (2) *Look and feel* considers the *concrete sensory experience* of how users perceive their interaction with the created artifacts.
- (3) *Implementation* scrutinizes the functionality of the artifact, and thus questions *how it works*.

Buchenu and Suri (Buchenu and Suri, 2000) related prototypes to the *look and feel* aspect and thus framed their understanding of prototypes in terms of the *concrete sensory experience* in an even finer granularity. By referring to the notion *experience prototyping*, they express three main activities that an artifact is meant to pursue within an interaction design context:

- Understanding existing user experiences and context.
- Exploring and evaluating design ideas.
- Communicating ideas to an audience.

In discussing the communicative aspects of a prototype (Erickson, 1995), Buchenu and Suri point out that designing interactive artifacts demands the

consideration of “methods that allow designers, clients or users to *experience it themselves* rather than witnessing a demonstration or someone else’s experience.” (Buchenau and Suri, 2000)

A more recent discussion on the attributes and purposes of prototypes in the design process has been initiated by Lim et al. (Lim et al., 2008), who defined the purpose of prototypes in the design process and their role as **filter mediums**. Lim et al. state that prototypes have to be considered and understood diversely, depending on 3 criteria:

- (1) The *material* that defines the physical appearance and thus communicates the completeness of the prototype; for example, a prototype made from office materials such as paper and glue will be perceived differently from a polished metal outer shell by the users and thus, *filters out* different aspects.
- (2) The second dimension incorporates the *resolution* of the prototype, meaning determining which level of detail is chosen for the current representation. This dimension closely corresponds to the concept of fidelity (Rudd et al., 1996). However, we assume that *fidelity* must be considered a different dimension as a prototype exhibiting characteristics of high *resolution* can be presented, as previously discussed, on a low-fidelity artifact and vice versa (Houde and Hill, 1997).
- (3) The third dimension covers the *scope* of the produced prototype which corresponds to the features and questions that the prototype is intended to answer.

These criteria also match the design of prototypes in the context of hybrid interaction forms, as in our cases, but we would extend them along additional areas of concern based on our own experiences:

- (1) Prototyping hybrid interactions later in the design process without any interactivity creates limitations regarding the *role, look and feel, or implementation*, and cannot be appropriately investigated using only non-interactive means. We argue that prototyping hybrid interactions during the *experience prototyping phase* demands a substantial amount of interactivity to adequately predict if a design concept has a chance of successful further development. We suggest that prototypes in later process phases should incorporate electronic components to simulate interactivity, as reliance on materiality alone does not adequately suggest completeness.

- (2) The scope of the prototype changes depending on the prototype's aim: either to investigate users' experiences with it or to discuss and answer construction-related questions all of which crucially affects the choice of materiality and interface elements.
- (3) The expertise required in creating a prototype also shapes the design process as prototyping hybrid interactions lacks a formal, established design process or tools built primarily for GUI based interactions.

2.6.1. Low-Fidelity Methods

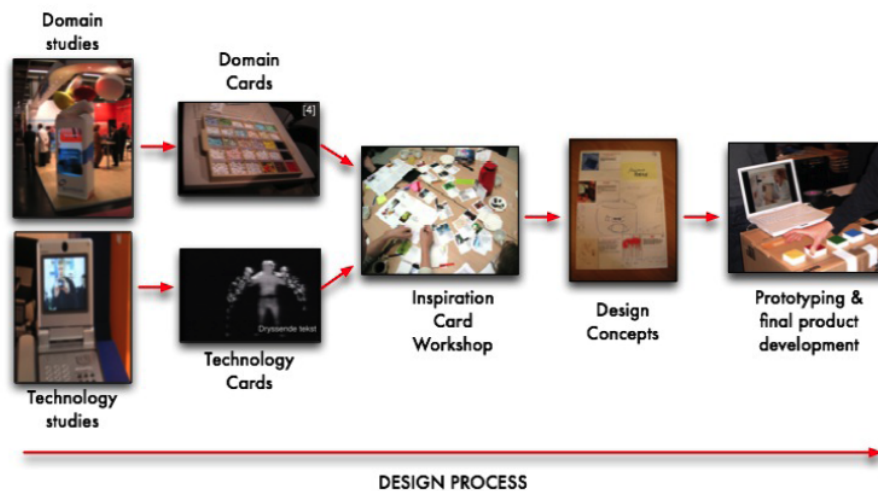

Figure 10. *Inspiration Cards* as a design process medium to systemically design for a specific context using additional auxiliary means (Halskov and Dalsgaard, 2006).⁵

Methods brought into the design process from theatrical practices, such as *acting out*, have been migrated into the interaction design community as valuable ways of *working through* a design concept on a physical level (Oulasvirta et al., 2003). Design approaches that include the use of artifacts and *active performances* by the design team members have been summarized under the terminology *informance design* by Burns et al. (Burns et al., 1994).

Using everyday objects as a low-fidelity means to express design scenarios *physically* has been explored by Svanaes and Seland (Svanaes and Seland, 2004).

⁵ Photo © by the referenced authors

In their workshop series they designed novel interactive systems by letting end users create sketches and low-fidelity artifacts.

Especially in design contexts with constantly changing requirements, these methods help team members to *work through* a concept from a users' perspective. Doing so leads a design team to a better understanding of the context involved and to gain awareness of unsolved obstacles (Buxton, 2007).

In our research we also wanted to support design teams by creating early physical expressions of their design concepts. However, we also aimed to provide step-by-step tutorials to make our methods more accessible and thus support the opportunity to allow early user involvement in our design context.

With their *Inspiration Cards*, Halskov and Dalsgaard provided a toolkit for ideation in difficult contexts (Halskov and Dalsgaard, 2006). While one deck of cards would refer to new technologies, other decks would represent places (see Figure 10). Through the combination of these cards and the constantly articulated solutions within the structured workshop sessions a team of designers could stay focused on a complex interaction relationship using these additional auxiliary means. Inspirational toolkits such as the one described by Halskov et al. (Halskov and Dalsgaard, 2006) or Brandt and Messeter (Brandt and Messeter, 2004) can be of assistance in supporting the early stages of the design process using low-fidelity solutions, requiring the consideration of various alternatives while envisioning a new system. Using a similar approach, Wahid et al. (Wahid et al., 2011) presented a toolkit consisting of graphical elements supporting the creation of design rationales.

Our implementations also build on the inspirational aspects of design tools which support quick changes during ideation. However, we also wanted to support the physical creation of mockups as framed by Sanders et al. (Sanders et al., 2010). Under a similar motivation Mueller created PICTIVE (Muller, 1991), a toolkit supporting the design of graphical interfaces in conjunction with end users through a design pattern language. However, while their exploration was conducted under laboratory conditions, we explored our toolkits *in the wild*, face to face with potential users, allowing spontaneous acting-out in a real context as suggested by Oulasvirta et al. (Oulasvirta et al., 2003).

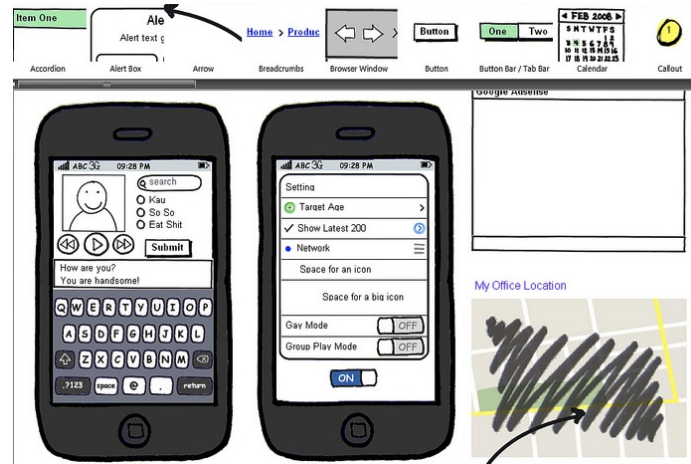

Figure 11. *Balsamiq Mockups*, an online toolkit to support the rapid expression of new GUI concepts by combining pre-defined elements.⁶

Chandler et al. (Chandler et al., 2002) presented experiences designing a mobile system in conjunction with potential users using low-fidelity means. In a similar manner, Tohidi (Tohidi et al., 2006b) discussed user sketches as tools for gaining a better understanding of users in their native contexts.

Contrary to their disparate approaches, we considered user involvement to be both *reactive* and *informative* during the early stages of the design process (Sanders, 2008). Approaches as discussed by Mueller (Muller, 1991) or commercial tools (e.g., Balsamiq Mockups⁷, see Figure 11) support the rapid creation of interfaces on a UI level, while our approach also supports early explorations of form factors. Another significant difference is that we address the ideation phase in projects involving interaction concepts that migrate away from traditional GUI based mental models.

On a physical level, the *Tech Box*, built by the interaction design firm IDEO (Kelley and Littman, 2005), serves also as an inspirational design process facilitator. It consists of a collection of novel or unique materials, gadgets and mechanical or electronic products.

⁶ Photo © Daisy Fung. Reproduced under a CC BY-NC-ND 2.0 License <http://creativecommons.org/licenses/by-nc-nd/2.0/deed.en>

⁷ <http://www.balsamiq.com/products/mockups>



Figure 12. Designers browsing the *Tech Box* (left) (Kelley and Littman, 2005) as a source for inspiration during early project phases of ideation provided by a collection of gadgets, materials or control elements (right).⁸

As demonstrated with the previously discussed toolkit built by Halskov and Dalsgaard (Halskov and Dalsgaard, 2006), the purpose of this physical miniature design library is to inform the design process by providing inspirations to a team of designers (see Figure 12). In that sense, these samples serve as additional three dimensional process artifacts, pushing designers to consider alternatives or reflect on unconsidered solutions. With our implementations, we wanted to offer a **variety of possible solutions** while keeping our pre-fabricated elements as generic as possible and so allow *ambiguous interpretation* (Buxton, 2007).

The approaches discussed above have been successful as supportive tools within a design team. However, the active involvement of the user during the early stages of design remains difficult, particularly in *wicked* (Rittel and Webber, 1984) design contexts. In the context of familiar design situations, like mobile systems, active user participation – in terms of prototyping on a low-fidelity level – such as was proposed by Svanaes and Seland (Svanaes and Seland, 2004), has been extensively explored by the research community in the past few decades (Brandt and Grunnet, 2000). However, if the design context is only barely comprehensible to users, as, for instance, the concept of *graspable interactions* has proven to be, the active participation of users early in the design process can become a challenging task. Employing supportive auxiliary tools, like the toolkits we've utilized, on both low- and mixed-fidelities, can be of great value in (a) communicating a complex interaction relationship in a short time-frame and (b) helping users to be actively involved even in the earliest phases of the process.

⁸ Photo © Christopher Arnold & the referenced authors. Reproduced under a CC BY-NC-ND 2.0 License <http://creativecommons.org/licenses/by-nc-nd/2.0/deed.en>

2.6.2. Mixed-Fidelity Methods



Figure 13. Mixed-fidelity prototyping, as practiced by Akaoka et al., using low-fidelity physical artifacts (left) and projected, digital artifacts (right), (Akaoka et al., 2010).⁹

On a two dimensional mixed-fidelity (GUI) level, Bailey et al. employed a toolkit that supports designers in creating multimedia applications through interactive (low-fidelity) storyboards that could be animated digitally (Bailey et al., 2001). Similarly to our approach, their intention was to allow users to quickly adopt and change properties of a system and thus, explore a variety of solutions simultaneously.

Mixed-fidelity prototyping methods on a physical level, as presented by Akaoka et al. (Akaoka et al., 2010) can comprise physical low-fidelity artifacts (Styrofoam) and projected (digital) interface concepts (see Figure 13).

This rapid prototyping approach allowed them to investigate the *concrete sensory experience* (Buchenau and Suri, 2000) using digital artifacts, even in very early prototyping iterations. On the contrary, questioning the *real* functionality on an implementation level is left out (Houde and Hill, 1997).

The approach presented by Avramhi and Hudson (Avrahami and Hudson, 2002) also involved a toolkit that was used for designing physical/digital input devices. Their underlying motivation for building this system was similar to ours, as they also aimed at simultaneous explorations of physical appearance and interactivity. Through the rapid assembly of mixed-fidelity interface elements, they could also

⁹ Photos © by the referenced authors

support the exploration of various possible concepts regarding potential interactions with their product. The authors also aimed at supporting communication through a flexible process medium. We crafted our approach to creating prototypes for physical interfaces so as to enable support for exploration into form factors, and for discovery of technological solutions that could be transferred to an implementation level while allowing the continued exploration into interactivity.

From a spatially distributed ubiquitous computing context, Ballagas et al. introduced *iStuff*, a framework to allow “the exploration of novel interaction techniques in the post-desktop era of multiple users, devices, systems and applications collaborating in an interactive environment.” (Ballagas et al., 2003)



Figure 14. *reactTIVision*, a prototyping framework for physical objects on vision based systems (Kaltenbrunner and Bencina, 2007) enabling users to create their own applications in a time and cost-effective manner such as the *Reactable* (Jordà, 2010).¹⁰

Considering the creation of physical input systems, Klemmer et al. introduced *Paper-Mache* (Klemmer et al., 2004), a toolkit using vision-based recognition and electronic tags. In their initial survey to investigate the requirements for their

¹⁰ Photo © Jordà, Geiger, Kaltenbrunner, Alonso / Music Technology Group. Reproduced under a CC BY-NC-ND 2.0 License <http://creativecommons.org/licenses/by-nc-nd/2.0/deed.en>

implementation they stressed that a tool in this context should support (a) many simultaneous input objects and (b) input at an object, not a pixel level.

Our implementations for physical input support also serve these characteristics; however, we also explored capacitive sensing devices which demand different technological solutions. For tangible objects on vision-based, interactive surfaces, Kaltenbrunner and Bencina authored the *reactIVision*¹¹ framework (Kaltenbrunner and Bencina, 2007). *reactIVision* consists of two parts: (a) low-fidelity fiducial tags that can be printed on paper and stuck on any physical object (see Figure 14), and (b) a computer vision framework that lets users with average programming skills create their own vision-based systems for recognizing tangible objects (see Figure 14). Utilizing this mixed-fidelity prototyping framework, artists and designers were empowered to create their own applications, like the *Reactable* (Jordà, 2010).

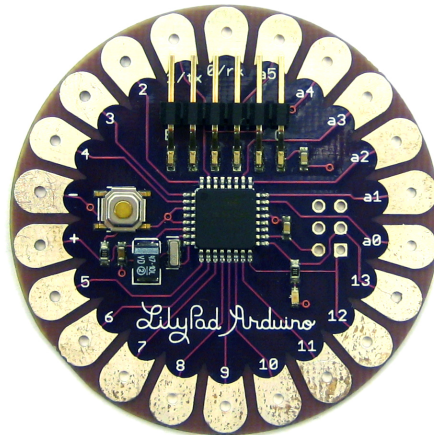

Figure 15. Electronic hardware platforms (Buechley et al., 2008) as *sketching medium* for low cost design explorations of interactions in a physical space.¹²

Using low-cost electronic platforms as a mixed-fidelity prototyping medium has been successfully explored by the design and research community (see Figure 15). Under the auspices of **sketching in hardware**, our idea involves an exploratory, playful and noncommittal use of electronics. Housed in reflective

¹¹ <http://reactivision.sourceforge.net/>

¹² Photo © David Mellis. Reproduced under a CC BY-NC-ND 2.0 License <http://creativecommons.org/licenses/by-nc-nd/2.0/deed.en>

practice, it enables users to explore the interaction design concepts that migrate away from traditional GUI-based mental models (Holmquist, 2006). In agreement with Buxton (Buxton, 2007), the previously introduced sketching attributes match this medium type, while the main focus of this method is to explore various parallel design solutions in a cost- and time-efficient manner.

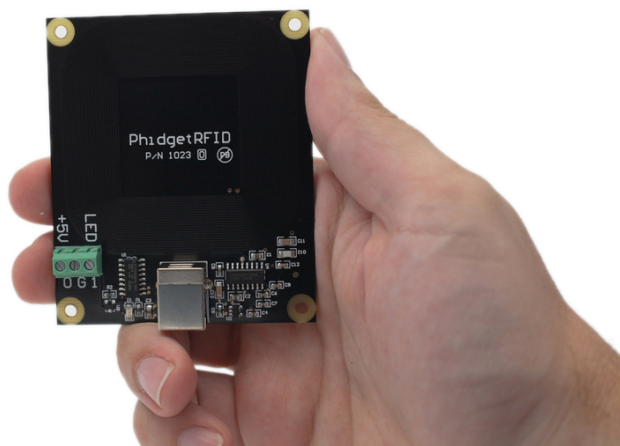

Figure 16. *Phidgets*, a prototyping toolkit to explore physical interaction concepts with no previous knowledge on electronics (Greenberg and Fitchett, 2001).¹³

The main driver for researchers and educators developing these electronic toolkits has been the benefit of removing low-level implementation burdens and having users consider creative design applications instead. Particularly for users without electronic fore-knowledge, these platforms empower them to easily explore applications that make use of various alternative input and output modalities for computer interfaces, such as switches, sensors, servos or light emitting diodes (LEDs). Greenberg and Fitchett introduced one of the first deployed toolkits, *Phidgets* (see Figure 16) (Greenberg and Fitchett, 2001). This prototyping toolkit lets users with no skills in working with electronics explore new physical interaction concepts by connecting pre-fabricated electronic elements via USB (e.g., servos, accelerometers, LCDs, interface I/O kits, RFID, etc.). These so-called *physical widgets*¹⁴ also have a robust application programming interface (API) that lets programmers interchange the functionality of these input and output modules rapidly.

13 Photo © Timo Arnall. Reproduced under a CC BY-NC-ND 2.0 License
<http://creativecommons.org/licenses/by-nc-nd/2.0/deed.en>

14 <http://www.phidgets.com/>

Holmquist et al. introduced their sensory board Smart-Its (Holmquist et al., 2001). While the motivation for creating this platform was similar to ours (removing implementation burdens), the intended use of their multitasking electronic boards was the rapid prototyping of wireless ubiquitous sensor networks.

Within the interaction design community and in educational institutions, tools such as Arduino¹⁵ (Mellis et al., 2007) have become an integral part of the design process for creating low-cost experience prototypes in an ever-changing design and opportunity space. The main advantage of these common prototyping platforms is (a) their low-cost factor and (b) their immense distribution within the community (Buechley et al., 2008). This makes constant re-use of soft- and hardware fragments easy and allows many users to develop their own prototypes within a short time-frame (Buechley and Hill, 2010). In that sense those platforms support *constant replication* as proposed by Gaines (Gaines, 1991), and provide an interesting example of how a science technology was successfully established as a mass platform.

However, these electronic prototyping platforms involve questioning the functionality of an artifact, or *how it works*, (Houde and Hill, 1997), while they do not support the concurrent exploration of form factors in equal amounts. This issue is also partly the result of the vast design spaces these tools are used to address.

Using parts of the previously discussed approaches, the *Wizard-of-Oz* approach to prototyping is an alternative cost and time effective mixed-fidelity design method in which parts of an interactive system are *faked* through, for example remotely manipulated action sequences. For the user the experience of interacting with such a system makes it feel as though it were *real*, despite frequently incorporating minor delays. *Wizard-of-Oz* prototyping is an excellent method for prototyping early instantiations of a system that usually require a large amount of technical expertise to create such as, for example, intangible speech-to-text input systems (Buxton, 2007). Klemmer et al. presented *Suede*, a mixed-fidelity prototyping toolkit for the creation of such input systems (Klemmer et al., 2000). Their informal tool enabled even non-experts to rapidly prototype initial design ideas for such a context via a GUI-based scripting and response language. Chandler et al. used this method alone through the expression of low-fidelity artifacts (Chandler et al., 2002). Based on their experiences, there needs to be an interesting discussion on extending low-fidelity prototyping methods to other (more complex) design contexts. However, we believe that the *Wizard-of-Oz* methods, like the ones previously discussed, were not feasible or

15 <http://www.arduino.cc>

appropriate to the challenges posed by prototyping intangible (hybrid) interactions. This matter is the result of the fact that dynamic changes over spatial distances are not especially predictable, and it was necessary to explore the users' experiences of an interaction mechanism (Dahlbäck et al., 1993). Instead, the previously discussed examples tackle a design space that refers to reoccurring interaction patterns.

2.7 Summary and Discussion

All of the previously described methods and examples, incorporating low or mixed-fidelity approaches, share similarities: they are meant to assist designers in difficult design contexts and help to reduce the expertise required in creating prototypes in *wicked* (Rittel and Webber, 1984) domains. While the low-fidelity approaches are mainly supporting the creation of innovative ideas and design rationales in the early stages, mixed-fidelity approaches are targeted towards the exploration of functionality and the user's *concrete sensory experience* of interacting with the created artifacts.

Tools and methods, like the ones previously discussed, provide good evidence for the declaration that new forms of interactions also demand new tools and techniques in developing them. In a quite large design space these tools are capable of providing focus and guidance. Thus, for a number of different applications, the context of the use-case feeds the design space for supportive toolkits. Furthermore, they act as communication mediums within interdisciplinary teams and help to aid creating mutual understanding. We consider these *communicational capabilities* in implementing our toolkits as one underestimated advantage that is crucial in difficult design contexts.

3. Observations in Current Design Practice

To gain a better understanding of the communication supporting roles of our toolkits, we¹⁶ investigated various issues that arose during the design process for interactive systems. We proceeded in this context inspired by the studies conducted by Adamczyk and Twidale, who analyzed tools supporting interdisciplinary teamwork (Adamczyk and Twidale, 2007). They identified a set of requirements that have not yet been addressed through the use of conventional collaborative methods. In their work, the authors describe the experiences gained during a two week student course held at a university. The students had to develop an innovative technology idea, and confine themselves to a low-fidelity prototype while expressing their concepts physically. This task was meant to incorporate feedback from the group and thus let their ideas mature over time via incremental changes in the concepts. This assignment proved to be an effective facilitator for enabling conversations on the theme of the workshop and the relationship of the *concrete sensory experience* to a product incorporating a new technology. Adamczyk reported that “this project also allowed for productive engagement across disciplines early in the class. A rapid small-scale subproject seems to be effective in team building, introducing new ideas and ways of working and creating a shared resource for illustrating theories and concepts from other disciplines.” (Adamczyk and Twidale, 2007)

In order to gain first hand insights into design practice and collaboration we undertook two field studies. The first was conducted in the context of an interdisciplinary university workshop on designing a mixed physical/digital interface. The second study was undertaken at a number of international design studios with senior level interaction designers as interview partners. In both setups we wanted to know how design teams were approaching their projects, which tools they were using and how interdisciplinary collaboration was influencing the process. These insights were then utilized as inspiration for our own implementations.

16 The scientific plural in this section refers to all persons involved in this research phase – namely Alexander Wiethoff and Hanna Schneider.

3.1 Observations From an University Workshop

3.1.1. Setup

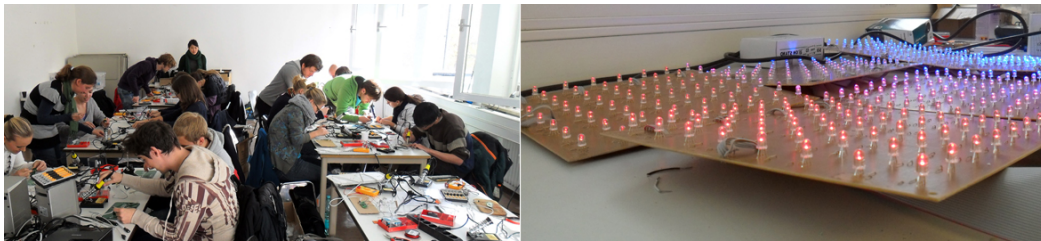

Figure 17. An interdisciplinary university workshop conducted with 24 students (left), had the goal of creating interactive instantiations of product ideas (right).¹⁷

The workshop, which we took as a reference point for our initial observations, was an interaction design course conducted in collaboration with two local universities and one industrial partner (see Figure 17). The goal of the workshop was to develop novel interface solutions for the large-scale manufacturing of household appliances. In total, 24 students who were in their 4th to 7th semester were involved, of which twelve were from the industrial design department and twelve were from the computer science department of media-informatics. The students worked together in teams of four over the duration of one semester (four months). Both disciplines were represented equally. One day of the week was specifically dedicated to regular team meetings and revisions with their advisors.

The teams' assignment was to envision and prototype a mixed physical/digital interface concept that could conceivably be produced in the near future (5-10 years from now). During the design process the teams used their own ideation methods for finding inspiration and for brainstorming. At the final presentation, the six teams showcased their hybrid interaction prototypes to the industrial partner that sponsored the workshop.

After the course ended, we interviewed the participating students to gain insights into their experiences during the design process. The interviews were conducted as follows: we interviewed a total of 19 students, twelve of whom were studying media-informatics and seven of whom were studying industrial design (twelve

¹⁷ Photos © Alexander Wiethoff

female, average age was 23 years). We separated the teams by their field of expertise and conducted semi-structured interview sessions which lasted 45 minutes in total and were video-taped for later analysis.

The students were asked about their experiences during the workshop, particularly in relation to generating ideas and creating prototypes in an interdisciplinary design team. The questions also covered the design process and what they thought of their team's collaboration and final outcome. For example:

- Were you satisfied with the final prototype of your team ?
- What were the biggest challenges for you individually ?
- How did you and your team approach the design process ?
- Did you always know what your team members were working on ?

To analyze the gathered data, we used the open coding scheme proposed by Corbin and Strauss (Corbin and Strauss, 2008). While systemically reviewing the data we identified relationships between situations, events and activities. Likert scale questions were coded, using an online tool by Max Maurer¹⁸, visualizing the response frequencies.

3.1.2. Findings

Considering the different design approaches in these two fields of expertise we found many of the same confusions and contradictory assumptions that were also discussed by Löwgren (Löwgren, 1995):

The general attitude of the computer science / media-informatics students was to structure the process by clearly defined milestones and individual deliverables, an attitude which stood in contrast to the unstructured process of the industrial designers. “A product design process is not as predictable as programming,” one design student stated repeatedly. Miscommunication between the different disciplines of the teams was reported to be one of the biggest challenges of the project.

In many cases, the computer science / media informatics students considered the creative output of the industrial design students to be *irrational*, *unrealistic* and *not rewarding*. The media informatics students considered it their *duty* to inform and warn the designers of technological limitations during the concept ideation phase.

18 <http://www.paje-systems.de/likert/>

Since the media informatics students had the task of programming the various design ideas' interactive instantiations at the end of the course, they found themselves constantly reflecting on whether an idea was feasible or not. One media-informatics student stated, "It is important that designers and computer scientists perform the ideation together. Otherwise the designers will dream up something that we cannot realize in the end." This statement seemed to encapsulate their doubts regarding the correlation between ideation and technical feasibility. This concern was further substantiated by one peer of the same discipline: "The problem was that the designers had no idea about what is technologically possible." In addition to the misunderstandings about technical feasibility, some of the industrial design students' methods for finding inspiration during the early phases of the process appeared to be irritating to some of the computer scientists: "They (the industrial designers) search for inspiration everywhere. Our thoughts were more restricted. We needed to develop a novel interface solution; why should I watch *Ironman*¹⁹ to get inspiration?" Instead of searching in a wider spectrum of ideas, the behavior of the computer science / media informatics students was constantly focused towards implementation, as one such student emphasized: "As a media informatics student, you just try to build a little application and explore an idea which seems to be promising. This way I can see if it really makes sense."

On the other hand, the media informatics students were perceived by the industrial design students as being *not very creative* and strongly *tied to implementation aspects*. The designers considered themselves to be *aimed at finding the best possible solution*, even if the envisioned concept is not feasible for the prototyping phase. "Practicality comes later on!" stated an industrial design student regarding this matter. One peer added: "I was thinking out-of-the-box! The question I have been constantly asking myself was: how might the targeted design space look in 2000 years time? I did not consider whether an idea was practical or not. Maybe we can find a solution later on! The computer scientists tended to combine existing solutions. When I tried to think further ahead, they interrupted me: No, that is not possible! But these discussions got us nowhere!"

The industrial design students repeatedly mentioned that, from their perspective, the ideation phase would have gone smoother without the media informatics students being involved. "Brainstorming with computer scientists is restricting. It could have been helpful to check the practicality of ideas, but only selectively. Maybe it would have helped to prepare the media informatics students for what brainstorming with designers is like." One industrial design student further stated: "If we had abandoned the idea for our final presentation in the beginning,

19 <http://www.ironmanmovie.com>

because it did not seem to be practical at this point – our final concept would not have existed in the end.”

Nevertheless, the majority of both disciplines stated that they would have appreciated working closer together than they actually did. This was supported by results of the follow up Likert scale question, “We always knew what our team members were working on.” The majority of the design students (six of seven) and more than half of the media informatics students (nine of twelve) did not agree or strongly disagreed with this statement.

3.1.3. Summary

In summary, many of the obstacles experienced during the design process were not the result of a lack of skills or technological constraints. Instead, most of the stated difficulties arose due to misunderstanding and communication difficulties among the different disciplines while collaborating on a difficult design context. Parts of the previously described anecdotes and findings might also be the result of the circumstances under which the project was conducted, in the context of a university course. However, our partners confirmed that some of the obstacles observed due to internal miscommunication also appear in industry product development contexts.

The preliminary findings of this study indicate that there is an opportunity space for supportive tools and methods that assist in fostering mutual understanding among team members of different disciplines in order to effectively design and prototype concepts in the domain of hybrid interactions.

3.2 Field Study on Current Interaction Design Practice

3.2.1. Setup

Inspired by the preliminary findings of the university workshop, we continued by directing our attention at investigations in the field. However, due to the fact that the students had only limited overlap in terms of the tools and techniques they used during the design process (as this was their first project in such a context), we decided to choose a different target audience for this setup. We conducted the next study setup in conjunction with three large interaction design studios, of which one was a large game development company and the others were independent design consultancies. In terms of scope, we targeted the research questions in this investigation towards assistive tools and techniques that (a) the designers were currently using and (b) involved toolkits containing properties they envisioned for difficult design contexts.

In total, we interviewed eleven participants with backgrounds in interaction design, industrial design, game design, user experience design and psychology (six female, average age was 32 years). The professional work experience of the participants was on average 8.5 years in their respective fields of expertise. The participants rated their own technical experience with a mode of 5 and their prototyping experiences in the context of hybrid interactions with a mode of 3, on 7-point Likert scales, ranging from 0, meaning *no experience*, to 7, meaning *very experienced*.

While gathering data, we conducted semi-structured interviews with each participant individually. All interviews were video-recorded for later analysis, and additional photos were taken for documentation purposes.

Each interview lasted 60 minutes in total and was conducted as follows: First the participants received a 5-minute introduction to the design context of hybrid interactions by showing them a selection of reference material, followed by a 5-minute discussion, initiated by us, on low and high-fidelity prototyping in this design context. Examples of research projects, such as those discussed in sections 2.3.1 and 2.3.2 were showcased.

The rest of the interview time was devoted to semi-structured interview sessions and included questions such as:

- Which design tools are you using in different phases of the process ?
- On which fidelity levels do you conduct prototyping ?
- What are your opinions / experiences with low-fidelity tools ?
- Which properties should a toolkit incorporate for the prototyping of hybrid interactions ?

Apart from our semi-structured guidance, we explicitly left enough *room* for the designers to tell their own stories, in which they referred to past projects or unusual experiences using novel design approaches.

3.2.1. Findings

When transcribing the interviews, we placed our coding scheme on the current usage of low-fidelity materials and any aspirations for additional prototyping methods they might have. Furthermore, we wanted to know if the designers would feel restricted by using pre-defined elements included in assistive design process materials.

“In the early stage of the design process, I want to be able to do crazy things. I don’t want to feel restricted by the tools I’m using. At the same time, however, I want basic shapes and forms as a starting point. To provide an analogy, *Playmobil* is too specific, but *Lego* is perfect,” stated a 31-year-old interaction designer, considering the ambiguity of their current prototyping means. On the other hand, a 32-year-old interaction designer expressed a more conservative attitude towards the use of assistive means: “For me, it’s always interesting to have well-established tools at hand in order to get started. These aren’t useful if they can’t be modified later when I want to experiment with different parameters.” A 45-year-old industrial designer described his design process in exploring form factors and interactivity by using mixed-fidelity prototyping methods: “In order to be flexible, we use basic geometric shapes ... and in order to make use of well-established concepts we often quickly try out standard UI elements like sliders, knobs, and buttons.”

The use and the limitations of low-fidelity prototypes were emphasized by a 32-year-old interaction designer when referring to the constant execution of these methods in her design studio: “Paper prototypes provide a way to quickly try things out, communicate ideas to others and combine and modify components.

However, they can only simulate activity flows and provide no means of system behavior or feedback.” The assessment of these limitations was supported by the summarized experiences of a 32-year-old interaction designer working in another studio: “Low-fidelity tools like wireframes or pure paper prototypes lack interactivity, and they can’t offer feedback and output.” However, two designers in the same company stated that their process heavily relies on creating low-fidelity representations as the first tangible artifact of a new design. A 33-year-old psychologist remarked, “Low-fidelity prototyping makes you think thoroughly about the problem and possible solutions. An abstract problem becomes tangible and real, forcing you to properly define requirements.” Despite these positive, reflective responses, a 30-year-old usability specialist working in a design consultancy described the limitations of this method that were experienced regularly in their design process: “Sometimes paper prototypes representing a great concept get rejected due to their inability to display transitions or similar interactive behavior. This is a drawback of current low-fidelity prototyping.” The same interviewee remarked further: “Quick and cheap low-fidelity prototypes are an efficient way to experiment which shapes, UI controls or materials suitable for the project,” which closely corresponds to the *filtering dimensions* of prototypes that Lim et al. explored (Lim et al., 2008), as discussed in section 2.3.

Considering the interview sessions, in summary, we found similarities throughout the participants' declarations. One recurring pattern in all three participating design studios was the need to involve different *gadgets*, *materials* or *mechanisms* throughout the early stages of ideation for inspirational purposes. Every studio we observed used some kind of physical material library, similar to the one in section 2.3.1, in particular the *Tech Box* of the interaction design firm IDEO (Kelley and Littman, 2005). “In the beginning (of a project), we conduct research on existing solutions for similar problems for inspiration. We also have a pool of established components, which is very valuable for ideation. It’s a good thing to make use of existing best practices, design patterns, and standard elements,” was a statement by a 27-year-old user experience designer, referring to their studio's material lab.

A 45-year-old game designer summarized their approach in early phases of ideation as very systematic in reusing artifacts: “We have three categories: Input, logic, and output. The logic depends on the specific use-case. For the input and output, however, we like to provide our development team with already existing components that might be trivial for techies but aren’t for designers.”

Another commonly mentioned aspect was the *lack of implementation skills* in difficult design contexts such as the prototyping of *graspable* interactions on

interactive screens: “It would be great to implement interactivity via visual programming,” stated a 25-year-old industrial designer in regards to the challenges of building prototypes in this context.

In addition, a 35-year-old user-experience designer wanted their interactive instantiations of design ideas to be as fast and re-producible as paper sketches: “If at some point I don’t want to restrict my prototypes to paper, I would like to be able to take any material or any random item lying around and still have it be recognized by a screen (to explore interactivity).”

Similar to statements like these, and considering the flexibility of a prototyping approach in the design context of hybrid interactions, a 32-year-old interaction designer remarked: “If I could assign behavior and visual attributes to a tangible user interface, then I would want to be able to modify their parameters.” Anecdotes such as these were supported by two participants who stated similar interests: “If I could use any random object and still be able to assign interactivity to it, that would be very valuable (for the process).” A 30-year-old usability specialist said this, in regards to the desired flexibility of a future prototyping method.

3.3 Summary of Findings

Looking at the gathered data sets as a whole, we learned that all participants acknowledged the value of low- or mixed-fidelity prototyping methods in their design environments. Furthermore, all participating studios referred us to the use of particular elements, such as a collection of different materials, gadgets, functional mechanisms or software artifacts for inspirational purposes during the early design process phases.

On the other hand, the various approaches to how to use these methods for the design of interactive systems varied; each interviewed designer had their own interpretation about how to apply these design practices in their work environment. Based on the recorded statements, we concluded that the majority of the participants considered a number of prominent aspects important for an assistive toolkit in our design context. We used the most relevant insights and their meanings as a conceptual framework for our implementations and summarized five qualities for our own implementations that were based on both study setups.

A toolkit for prototyping hybrid interactions should therefore have the following properties:

- Be highly flexible.
- Provide access to users with limited engineering experience.
- Allow ambiguous interpretation of the created artifacts.
- Support simultaneous explorations of shapes and interactivity.
- Assist (interdisciplinary) communication.

The design space that our implementations address is quite large. Therefore, guidance is necessary when categorizing them in order to view their capabilities and limitations at once and facilitate their use in projects. In the next section, we therefore show how to classify our tools in a purpose build visualization, that serves as a quick reference to learn about the different characteristics.

4. Classification

To frame our implementations we used additional parameters that visually presented similarities and differences. Furthermore, the selected parameters presented various common aspects and capabilities of our implementations. Their purpose is to clarify the different properties at-a-glance, such as the specific points in the design process at which the tool is intended to be used. In total, we use six main characteristics to classify our research implementations:

- Fidelity.
- Resolution.
- Number of users.
- Spatial dimensions.
- Engineering expertise.
- Process stage.

4.1 Fidelity and Resolution

The concept of fidelity and resolution, as discussed in section 2.3, represents two important aspects of a toolkit. The differences in these parameters represent the various questions the artifact is intended to answer (Houde and Hill, 1997), or as Lim et al. expressed, the *filtering dimensions* they are meant to address (Lim et al., 2008). We also take the notion of *fidelity* to mean proximity to the eventual (final) design (Buchenau and Suri, 2000). By using the term *resolution*, however, we take into consideration the amount of (design) detail incorporated by the prototypes and tools. In this respect, the parameter *fidelity* is more closely related to the design process stage than the *resolution*.

4.2 Number of simultaneous users

Pre-testing a prototype in the design context of hybrid interactions under live public conditions with a large audience and multiple users interacting simultaneously will inevitably affect the design of the prototype and the underlying system. Designers of these systems should therefore consider how they intend a large number of users to interact simultaneously.

For example, in one of our case studies we explored a high-fidelity prototype that lets users interact with the media façade of a building using mobile devices (Boring et al., 2011). Revealing insights into group experiences in this context was made possible using three similar devices at the same time. A larger number of users interacting simultaneously would have created additional issues in the systems' infrastructure and possibly caused frustration among the users due to interference. At the same time, a small number of users interacting simultaneously would have prevented the design team from discovering these important findings and insights in the first place.

4.3 Spatial Dimensions

The sheer physical size of the prototype plays an important role in the design process of hybrid interactions, since the question of portability strongly affects the evaluation cycle. For example, prototypes in this realm can be distributed over and throughout an entire environment. In other cases, transportation for evaluation purposes can become problematic because state-of-the-art hardware such as an interactive tabletop computer is bulky and heavy. Consequently, a

miniaturization of the actual interface elements might be necessary in some cases in order to conduct even early tests with users before the final implementation.

4.4 Engineering Expertise

Creating prototypes in the realm of hybrid interactions demands people with a diverse skill-set, as the findings in section 3.2 highlighted. In order to address the problem and opportunity space in this context successfully, the constant creation of prototypes is essential, which in turn requires people with engineering skills to create them. As a result, the functional *quality* of a prototype in this domain also reflects the expertise of the people creating them which can lead to varying results in an evaluation. To assist researchers and designers, *Microsoft*, for example, equips their interactive surfaces with fiducial markers that are easy to stick-on any arbitrary object and a corresponding software API, which demands less engineering skills to create prototypes than freely available frameworks (Kaltenbrunner and Bencina, 2007).

4.5 Process Stage

As we reflect on the interaction design process with its individual phases (Sharp et al., 2007), we are also keenly aware that the usage of a prototype should match the phase of the design process (Tohidi et al., 2006a).

A prototype can cover the full range of fidelity and resolution grades in each process stage but it can also encompass a completely different meaning according to the scope (Lim et al., 2008). A categorization should accommodate the particular process phase addressed despite serving different purposes. It should also lead to discovering insights in coordination with users or while investigating the users' concrete sensory experiences in later phases (Buchenu and Suri, 2000).

4.6 Classification Visualization

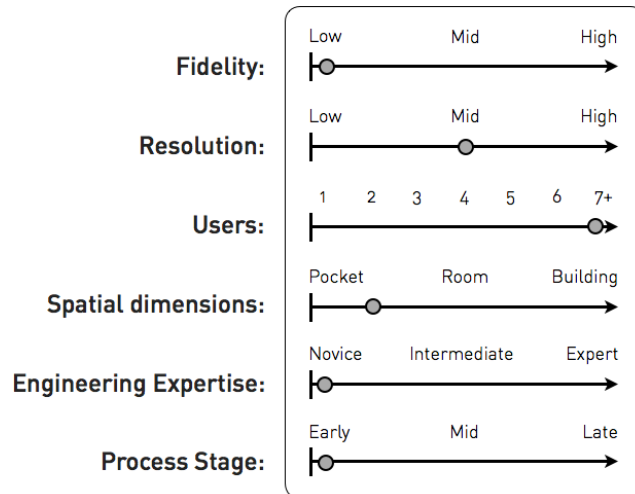

Figure 18. A visual representation of the most crucial aspects helps identifying important parameters at-a-glance.

To make our implementations easily comprehensible to the reader we will provide a visual representation of the previously discussed parameters at the end of each section (see Figure 18). The visualization serves as a *business card* or quick reference for our implementations, and simplifies comparisons:

The granularity of this classification was chosen to allow designers to rapidly judge the parameters' capabilities and references. However, we explicitly left the framing approximate enough to accommodate our own interpretations, particularly those on the nature of prototypes.

Because they do all fall somewhere on a continuum, this organization of the parameters doesn't enable the pin-pointing of exact parameters. Instead, the indicated borders are blurred so that quick modifications can be made to slightly increase or decrease some of the parameters. However, the chosen granularity of the parameters allows others to use or interpret our approach appropriately.

III.

Prototyping Tangible Interactions



It is relatively easy to design for the perfect cases, when everything goes right, or when all the information required is available in proper format.

Don Norman

5. A Prototyping Toolkit for Design Research

In the following section we discuss our experiences conducting user research for hybrid interactions using a purpose-built low-fidelity prototyping toolkit, creating early physical instantiations of design ideas. While the first sections are devoted to a presentation of the elements we used, in later sections we discuss our experience of using the toolkit, namely through the designing of a new guidance system in cooperation with a large museum of contemporary art. A preliminary user study, performed in the wild, exemplifies the use of the toolkit and its assistive function in conducting user research. We use this case study as an exemplary project to provide insights into how such a tool can be used and integrated into the design process. Finally, we discuss the value of such an extension to the design process.

5.1 Design Research on Hybrid Interactions

Compared to graphical interfaces, designing hybrid interactions presents a range of different challenges. It is necessary to address these challenges through an understanding of users within their context, as discussed by Taxén (Taxén, 2004) or Oulasvirta et al. (Oulasvirta et al., 2003). Such an approach is widely accepted as a valuable design activity in the early phases of the design process. These activities are especially helpful when seeking insights into the potential success of a new system, eventually leading to either a usable and enjoyable outcome or a complete change in the direction of the project.

5.2 Sketching with Objects

To address the challenge of conducting user research into novel interaction concepts in support of design teams, we created a low-fidelity paper prototyping toolkit consisting of various pre-designed graphical elements (see Figure 19). The toolkit is aimed at the development of low-fidelity expressions in the context of hybrid interactions. It is intended to both provide inspiration regarding interaction possibilities to the design team and to allow for the creation of mockups in a unified design language. In short, it lets users create mockups of interaction concepts in a neutral and consistent style.

The elements are depicted as different interaction icons, form factor suggestions, and graphical patterns (see Figure 19). Explaining a novel, complex interaction relationship within a short time-frame to potential users is a difficult and time-consuming task. By giving designers and developers the means to create quick mockups for communicational purposes while conducting user research, these low-fidelity artifacts can help make new concepts more *graspable* and can be of substantial assistance to a design team. The resulting artifacts' appearance allows for open and ambiguous interpretation and does not confront an audience with superficial design elements, like colors and concrete materials, that could provoke unwanted feedback on irrelevant points of discussion. Further, these auxiliary means allow a more democratic creation of mockups in a unified design language that helps team members with limited sketching skills expressing their ideas physically.

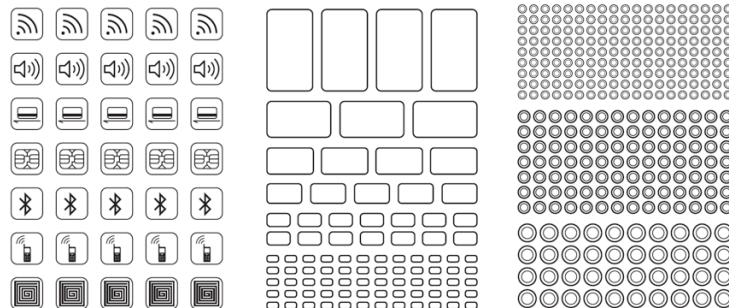

Figure 19. Three sample pages of the toolkit: interaction icons (left), form factor varieties (middle), and graphical patterns (right).²⁰

Using our toolkit, we²¹ explored the design process within an industrial context. This avenue allowed us to consider the supportive role of *Sketching with Objects* throughout the development of a new multimedia museum guiding system.

5.2.1. Components and Use

The created low-fidelity prototyping toolkit, three sample pages are depicted in Figure 19, is comprised of 53 sheets of A4 paper. The toolkit contains three main categories which are equally distributed over the pages:

- (1) Interaction symbols for a generic representation of an interface (e.g., near field communication (NFC), Wi-Fi, camera tracking, touch or physical interfaces, etc.), (see Figure 19, left).
- (2) Form factor varieties for more detailed representations of GUIs (e.g., squares or circles ranging from 1-21cm), (see Figure 19, middle).
- (3) Graphical patterns for buttons or other uses (e.g., dotted elements in various resolutions), (see Figure 19, right).

These graphical elements are included in variations to provide enough freedom for the creation of mockups in different sizes. As the toolkit is printed on paper,

²⁰ Photo © CIID

²¹ The scientific plural in this section refers to all persons involved in this research phase – namely Alexander Wiethoff, Heather Martin, Bettina Conradi, Sophia Groß, Martin Hommer, Robert Kowalski and Karin Guminski.

its elements were cut out and glued onto foam-core or cardboard using low cost office equipment (see Figure 20).

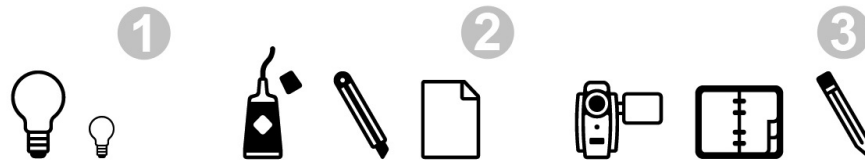

Figure 20. A typical use of the toolkit in the design process (from left): (1) A design team brainstorms new interaction concepts and ideas. (2) Using standard office equipment in conjunction with the toolkit, the team creates low-fidelity mockups of the most promising concepts. (3) The created mockups are used for conducting user research or serve as artifacts (probs) in video sketches.

In a typical usage scenario, the toolkit is utilized in the early phases of ideation and user research (see Figure 20). This can be the case, for example, when a design team is confronted with the creation of a system that incorporates novel interaction forms, particularly those that might be unfamiliar to users. The team can then use the toolkit as a means of inspiration during ideation and brainstorming sessions (see Figure 20, left). Such an approach was also proposed by Halskov and Dalsgaard with their inspiration cards workshops (Dalsgaard and Halskov 2006). However, in their setting, the goal of these sessions was to envision holistic design concepts on a higher level while our aim has been to create low-fidelity mockups that could also be used to communicate with potential users during the early process phases. In a consecutive step, the toolkit can be used to create artifacts with standard office equipment. The artifacts may result from the most promising ideas of a previous ideation session (see Figure 20, middle), so the created mockups would then serve as a means of revealing insights into the field studies, working in alignment with potential users and helping to communicate the novel interaction paradigm to its chosen audience (see Figure 20, right).

In the following we exemplify how we used the toolkit in an industrial context to provide insights on how *Sketching with Objects* can be practically applied. We used the toolkit to gather insights from users regarding preferences between a number of our proposed interaction design concepts. These insights were then used to further drive the design process of the project.



5.3 Industrial Case Study

Developing a multimedia guide in conjunction with an industrial partner, (e.g., a large museum of contemporary art²²), we aimed to employ novel ways of information retrieval, like the one presented by Hornecker and Stifter (Hornecker and Stifter, 2006). We also considered solutions that would deliver content in a more individual way, as exemplified by Wakkary and Hatala (Wakkary and Hatala, 2006), Kortbek and Grønbaek (Kortbek and Grønbaek, 2008), or Horn et al. (Horn et al., 2008).

The project itself was undertaken following an extended user-centered design process using the mockups explored in *Sketching with Objects*: the artifacts that were created using the toolkit were utilized during user research sessions, and were intended to simplify communication during interviews, enabling the team to explain technologically complex design concepts (see Figure 21):

- **Key Data Collection:** In this phase, we looked at reference projects dealing with novel interaction mechanisms implemented in the given design context (see Section 5.3).
- **User Research:** We conducted a standard user study to discover major problems and get a better understanding of the given context (see Section 5.4). In a consecutive iteration we repeated this phase while using the created mockups as process extensions (see Figure 21 & Section 5.6).
- **Data Analysis:** Based on the previous phases, we used our findings as starting points for the development and refinement of design concepts.
- **Design Concepts:** We turned the identified problems and opportunities into design concepts in the form of mockups. We considered the most crucial key elements of the interaction from the users' perspective.
- **Prototypes:** After presenting these scenarios to our project partners in an intermediate presentation, we created paper-based low-fidelity mockups through a toolkit specifically created for this purpose (see Section 5.2 & 5.5).
- **Evaluation:** To gather data and insights during the process we undertook field studies involving semi-structured interviews, video documentation and consecutive open coding data analysis (see Section 5.4 & 5.6).

22 <http://www.pinakothek.de/en/pinakothek-der-moderne>

The artifacts generated using *Sketching with Objects* served to focus attention into possible opportunity/solution spaces, as did the questionnaires filled out during the interviews with end users regarding their needs and desires.

The following figure depicts our experiences with the exploration of this tool, particularly in developing the new aforementioned guide for an art museum, thus documenting a possible design-process extension (see Figure 21).

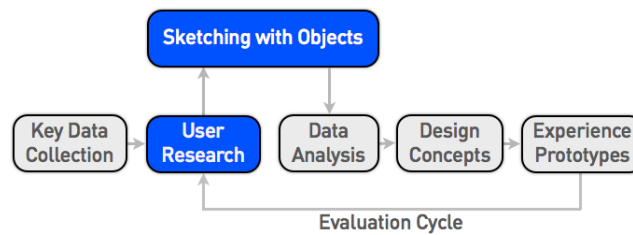

Figure 21. An extended model of a user-centered design process with our focus on the user-research phase (highlighted in blue).

To gain insight into the users' experiences with current multimedia guiding systems, we conducted an initial round of interviews *in the wild*.

5.4 1st Set of Interviews at the Museum

5.4.1. Participants and Setup

The interview sessions were conducted at a large European museum of contemporary art during a weekday afternoon. The time-slot of 2pm-4pm was perceived as being *ideal* as there was a greater likelihood of reaching a broad variety of age groups rather than the homogeneous gatherings observed during the morning and evening slots. A team of four interviewers (two female, average age was 27 years) approached visitors in randomly composed teams of two, but were encouraged to garner a diverse user sample, along the lines of both age and gender. Semi-structured interviews were chosen as the most likely situations to encourage unexpected personal stories and ideas while enabling the collection of data. Each interview lasted no more than 20 minutes in total. All interview sessions with participants were visually recorded for later analysis. We

interviewed a total of ten participants (average age was 45 years) focusing in the interview sessions on (a) their experiences with the current guiding systems in general and (b) which features they would appreciate in a future device.

5.4.2. Data and Analysis

In analysing the gathered data, we used the open-coding scheme proposed by Corbin and Strauss (Corbin and Strauss, 2008).

The multimedia content was independently transcribed by two researchers and compared in subsequent setups. In this series of interviews, researcher-denoted concepts were used to consider *problems* and *aspirations* (meta level) with the current technology infrastructure and the resulting personal *outcomes* and *consequences* (sub-themes level).

5.4.3. Preliminary Findings

In summary, we noticed that the majority of participants (eight) were dissatisfied with the extant format of content delivery. They stated that the explanation of the works of art simply took too long. For example: “I switch it off because I get bored,” said one male participant. Other such quotes were collected and allocated to the researcher-denoted concept of *consequences*. Another recurring outcome of the interview sessions involved the need of a feature allowing the participant to have choices regarding content display (e.g., artists’ influences). This need was mapped to *aspirations*.

Regarding the design process of this phase, we aimed at consolidating and narrowing these insights via a second round of interviews, this time addressing possible *solutions*. We arrived at these solutions, intended to address the problems with the current technology infrastructure collected in the previous interviews, by confronting participants with the results gleaned from our toolkit. Besides directing interviews toward potential form factors, we also tried to emphasize the novel interaction concepts resulting from a brainstorming and prototyping session.

5.5 Brainstorming and Prototyping Session

Based on the preliminary findings of the interviews, a brainstorming and low-fidelity prototyping session was carried out, using the toolkit (see Figure 21). The five participants were selected according to their diverse backgrounds: one with a Ph.D. in art history and professional experiences in exhibition design, one research assistant with a background in multimedia design, two grad students from computer science and one research assistant with a background in software engineering (three female, average age was 31 years). The mix of art and computer science disciplines was chosen to represent a diverse design team with the backgrounds necessary to design and implement a novel interactive system, such as the one described by the circumstances in question.

The session was conducted in an art studio, documented via photographs and audio transcripts, and lasted three hours in total. The participants received a 15 minute introduction to (a) the problem space ascertained through the preliminary findings of the initial interviews and (b) the toolkit, its elements and their practical use within a low-fidelity prototyping session. The participants were then instructed to come up with ideas for a new multimedia guide for an art museum while incorporating novel interaction mechanisms.

This exercise was achieved through an affinity diagram and the subsequent clustering of sub-themes like *information retrieval* or *add-ons*. The participants were instructed to express their ideas physically via the toolkit.

None of the participants were familiar with the toolkit itself, but they had some experience with paper and low-fidelity prototyping techniques prior to the meeting.



Figure 22. Impressions of the initial brainstorming and prototyping session using the toolkit to create physical instantiations of novel product ideas.²³

During the session, three out of 25 initial ideas were taken into further consideration and turned into low-fidelity mockups by the participants (see Figure 23). This reduction and focus on certain design ideas was undertaken via *voting* on the best concepts, using *sticky dots*. Each team member was instructed to pick their favorite concepts and explain their choices after voting. The design concepts with the greatest number of votes were discussed by the team members and the least promising were filtered out, resulting in the incorporation of diverse interaction mechanisms within the core ideas, thereby presenting a variety of possible design solutions in future interview setups.

The participants came up with ideas that covered a broad spectrum of design opportunities. One team member had the idea of a wearable screen that could display multimedia content and serve for indoor-navigation. She further had the idea of extending the concept with a pen-like device, or stylus, that would enable the quick *tagging* of artworks and the subsequent receipt of more information after the visit (see Figure 23, left). Two other team members favored the idea of a robust and easy to use near-field communication (NFC) enabled device that would recognize the artworks by *touching* different zones on the museum guide to reveal multimedia content that could be delivered in three formats: audio only, text & videos, and a combination of both (see Figure 23, middle). Another participant imagined a relatively small device that would comfortably *fit in every pocket* and serve as an audio guide that could be operated by *pointing* towards different artworks. The device would be *tracked* through a camera equipped system and start and stop the delivery of content according to the users' position. A removable part of the device was envisioned to have the ability to store and transmit the collected data to other devices (i.e., tablet or laptop at home) and thus continue the visit and chain of interactions with the system to other places (see Figure 23, right).

5.5.1. Findings of the Brainstorming Session

We observed that during the brainstorming and low-fidelity prototyping session, the toolkit was well received and used, while the participants appreciated the opportunity to have a medium to “begin working with” rather than “creating everything from scratch.” Additionally the toolkit helped the team members to express and **work their ideas through in a practical manner**. The implementation allowed an interdisciplinary team to create mockups in a unified and consistent style which is especially important when the concept of an interaction should be judged rather than the appearance of the prototype. In that sense the toolkit can aid team members who might have limited sketching skills

(i.e., engineers or developers) to produce mockups by themselves which are equally appealing as those created by, for example, designers or artists.

However, some elements were not used at all, for example, as the participants preferred to *sketch* directly on the low-fidelity representation of product instantiations, the sheets with representations of numbers and letters. These respective elements remained unused throughout the session and were therefore removed from the toolkit. The participants also showed an individual, creative use of the toolkit when they included pre-fabricated elements to build their mockups (see Figure 23, right).



Figure 23. Initial ideas from a brainstorming session were rapidly turned into low-fidelity mockups representing different interaction opportunities: A wearable, GUI based device on the right, a NFC enabled device in the middle and an idea for using *pointing* as interaction mechanism with a removable data storage cap.²⁴

5.5.2. Design Concepts

As has been pointed out, the envisioned concepts covered a broad range of interactions and alternatives regarding size and shape, in summary:

- A wrist-wearable device with a physical artifact for *tagging* topics of interest (works of art) and a screen displaying indoor navigation (see Figure 23, left).
- An NFC system for selecting works of art with audio/visual output possibilities (see Figure 23, middle).
- A pocket-sized input device with (a) a removable element for *tagging* points of interest, (b) automatic activity recording (tracking) and (c) a smaller segment for later use (i.e., at home) of the recorded information (Figure 23, right).

The mockups then served as a means of gathering insights into which of the envisioned concepts might be favored by potential users.

In addition to the previously described mockups, we created variations of the preferred form factors for future devices (see Figure 24 & Table 1).

We used these mockups to judge which of the presented samples potential users would consider *comfortable*.



Figure 24 & Table 1. Low-fidelity elements focusing on form factors for the use in participatory design-oriented sessions *in the wild*.

5.6 2nd Set of Interviews at the Museum

5.6.1. Participants and Setup

The second set of interviews was conducted under conditions similar to the first setup in terms of interviewers, location, time-slot and documentation. In this setup we interviewed a total of eight participants (average age was 44 years). While the goal of the first interview session concerned the general perception of extant technology, in this interview we directed the conversation towards some of the previously described design ideas. At the onset of the setup, we gave the participants a 5 minute introduction to the topic and the goals of the interview (e.g., designing a new guidance system, filtering design ideas, etc.). We then undertook a semi-structured interview in which we introduced them to our interaction design concepts using the mockups depicted in Figures 23 and 24.

The different design ideas were demonstrated through *acting-out* by the interviewers. For example, an NFC interaction was explained to the participants via *holding* specific mock-ups against an artifact in the museum, while simultaneously describing the envisioned result. Independent from the discussion of different interaction concepts, at the end of each interview we questioned the participants about their preferences as to the created form factor variations (see Figure 24). We did this to investigate what artifact dimensions (minimum/maximum) would be most comfortable for the participants to carry around a museum.

5.6.2. Data and Analysis

In analyzing the data, we again relied on the open-coding technique developed by Corbin and Strauss (Corbin and Strauss, 2008), but this time we used researcher-denoted concepts for analyzing the data that focused on the *appropriateness* (meta theme) of the alternative design solutions and the achievement of their *objectives* (sub themes). These objectives included whether or not they would use a design concept for a specific purpose at all. We also focused on the carrying out of *strategies*, especially in the light of how users would extend the concept through their own ideas.

5.6.3. Findings

We received diverse feedback from the participants while discussing the different interaction concepts. We were even able to group the anecdotes into our coding concepts. Examples of anecdotes are shared in the following section.

A feature allowing the user to record their activity in the museum (e.g., a design concept as depicted in Figure 23, right) was repeatedly mentioned positive: “In that way the device becomes a medium of information but also of acquisition,” said a 35-year-old male participant referring to this design concept, who stated his interest in “downloading information” and “...creat[ing] a slideshow of visited works of art...” Another male participant appreciated the opportunity to “tak[e] the visit home” on a USB-stick or to “...share it via e-mail or Twitter...” This opportunity was also independently appreciated by two 32-year-olds who fancied the idea of “...having an interface artifact as a physical token to take home...”

Concerning the most appropriate feature for using the guide to recognize works of art, interviewees frequently mentioned a feature they viewed to be a promising technological solution: an NFC recognition mechanism (similar to Figure 23, middle) that was either semi- or completely automated (e.g., via camera tracking of the visitors as in the case of the concept depicted in Figure 23, right). However, one 35-year-old male participant remarked that this feature would be dependent on his familiarity with the museum's collection before the visit: "If I know the art museum's collection, I would prefer to browse for specific items directly and operate the guide manually, otherwise I would prefer an automated mode..."

Some interviewees also brought up their own ideas while interacting with the mockups: one male 60-year-old participant stated that he would appreciate a feature allowing him to make quick sketches (e.g., referring to the mockup depicted in Figure 22, left): "This feature could also be very valuable in rallies with children." Considering the envisioned indoor-navigation, he further stated: "Seems like a reasonable idea; why not, for a specific user group?" On the other hand, his wife, 58 years old, commented critically on this feature: "It would prevent me from freely exploring the museum; I would not use it at all."

Concerning the investigation of form factors, six of the eight participants indicated that, after discussing the alternatives (see Figure 24), they would feel comfortable with a shape measuring 10cm x 17cm. However, a 30-year-old female participant stated she was not *comfortable* with the aspect ratio of the rectangular shapes.

The 2.5 hours of video documentation recorded in the second interview set were analyzed via open-coding, and the concepts that were developed were grouped and interpreted to build the next step of the project's design project: further substantiating our findings. For the benefit of our industrial partner, we created a written summary including recommendations for the continuing design process. The report included recurring patterns found in our chosen researcher-denoted concepts, and allegedly inspired the future design process of the project.

5.6.4. Drawn Design Conclusions

Apart from the complete documentation of the gathered material, we highlighted four points that we considered to be the *key* findings of our research:

- Automated or semi-automated (e.g., NFC) recognition of the works of art was persistently mentioned (five of eight) as a favorable interaction concept when compared to alternative interaction concepts such as wearable devices or GUI based systems.
- Compared to other samples, the form element measuring 10cm x 17cm was perceived as a *comfortable* size (six of eight) for a new device compared.
- An *art recommendation feature*, in conjunction with indoor navigation, was perceived as a good design opportunity by four interviewees.
- Activity recording and *taking the visit home* via a physical token (e.g., via a USB stick) was received positively as an additional feature.

We suggested to our partners that these considerations should not be considered “set in stone”. However, we also suggested that the 1st and 2nd points of these recommendations may crucially influence the acceptance of a new guidance system and should be taken into account for further investigations (e.g., an experience prototype on a higher fidelity), as should the continuation of the design process with additional interviews at the museum.

5.7 Summary and Contribution

In summary, we presented the early phases of developing a new electronic product using an extended design process *in the wild*.

We created a low-fidelity prototyping toolkit that was utilized as a design process extension and that can be used by others in their work. This toolkit has the potential to inspire designers during the early phases of ideation and to assist in the creation of low-fidelity mockups for the purpose of *expressing* design ideas. Doing so can be of assistance when designing interactive systems that incorporate new, unfamiliar interaction forms. On the other hand, using pre-designed elements in the design process can also, to some extent, constrain creativity (Shneiderman, 2000). Despite that possible constraint, the advantage of having a medium with which to start working when facing domain specific challenges can compensate for this limitation (Margolin and Buchanan, 1995).

In our case the toolkit supported the project team by (a) providing inspiration for designers to envision novel interface solutions and by (b) creating mockups that were used in interview sessions with potential users *in the wild*. The evaluation of the toolkit itself has yet to be further consolidated through additional case studies. A follow-up project may take up this matter and expose the presented implementation to a different context. Doing so will provide the opportunity to develop the toolkit further and involve online communities. A digital, editable version of the low-fidelity prototyping toolkit may be an interesting source of these tools' extensions through a growing user group and may prove beneficial for the success of the approaches described above.

Classification

We consider the following aspects to be resident in the conceptual framework that underlies the created toolkit:

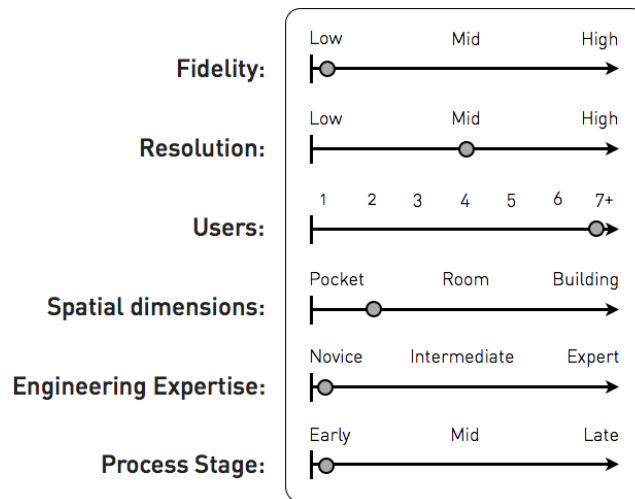

Figure 25. The visual classification of *Sketching with Objects* and the individual parameters

- The fidelity of the toolkit is kept intentionally low to allow rapid assembly and minimal time investment to create a variety of design alternatives during the early phases of ideation.
- The resolution is instead expressed at moderate levels to allow various creative implementations by the users.
- Our implementation can be used by an unlimited number of users simultaneously as the tool is freely available and reproduce-able at very low cost.
- The resulting artifacts incorporate small size, which would leave users with minimal transportation hassle, particularly in remote location contexts.
- Even novice users with no prior experience can use the toolkit and create artifacts in a unified and neutral design language.
- *Sketching with Objects* is intended to be used very early in the design process to support the ideation and communication of novel interactions.

6. Prototyping Tangible Interactions on Interactive Surfaces

In this section we²⁵ share our experiences in creating a prototyping toolkit for TUIs on interactive screens. In the first part of the section we discuss our approach in creating a tool that supports the exploration of different form factors for low-fidelity TUI instantiations. Next we share our experiences applying an initial version of the toolkit to developing an application on a desktop computer using a participatory design approach. The middle of this section is devoted to the extension of the toolkit to devices that work with the new generation of capacitive surfaces. In this context we present our findings, including the provision for providing a time and cost-effective tracking technology that does not demand electronic fore-knowledge. Next we discuss the use of this method and the previously introduced toolkit in an industrial case study, developing a consumer electronic product in conjunction with a large industrial company. The final part of this section provides a discussion of the chosen approach and concludes with a summary of these contributions.

6.1 Challenges Designing Tangible Interactions

As discussed in Section 2.1.1, the design of graspable interfaces demands consideration into both form factors and interconnected interactive behavior (Wiethoff et al. 2011), (see Figure 26). Early prototyping of such TUIs is critical.

Unlike traditional GUIs, these approaches, methods and idioms are still evolving. Possible starting points for the design process in this field remain unclear. However, without early prototyping, it is far too easy to produce poor designs. Low-fidelity prototyping is especially important for evaluating a wide variety of (TUI) designs, and choosing what appears to be the most promising amongst them for further development (Wiethoff et al. 2012).

25 Parts of the work presented in this section has been published in a scientific paper (Wiethoff et al. 2012). The scientific plural refers to all corresponding authors – namely Alexander Wiethoff, Hanna Schneider, Michael Rohs, Andreas Butz and Saul Greenberg.



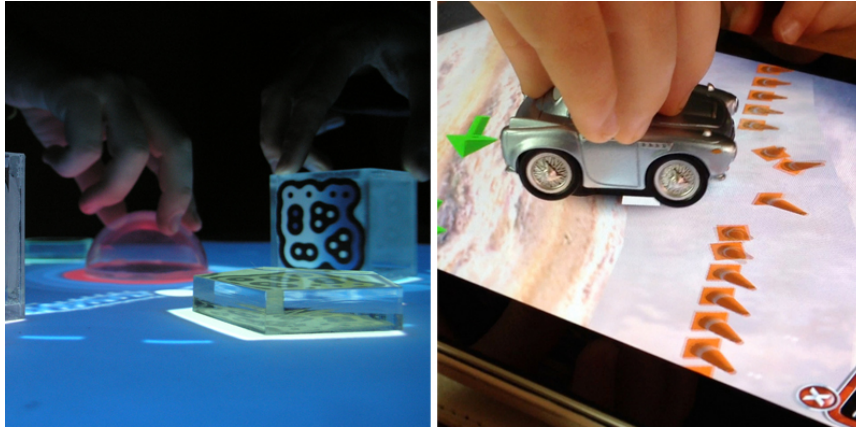

Figure 26. Practical examples of TUIs atop interactive screens that provide new interactions in musical (left: Reactable²⁶) or playful contexts (right: Appmates²⁷)²⁸.

Low-fidelity prototypes in this context work because: they do not confront users too early in the design process with unimportant design details; they allow non-experts to participate in collaborative design sessions; and they invite high-level user testing (Buxton, 2007). This is why low-fidelity prototyping methods abound for GUIs (Snyder, 2003) are widely accepted and considered essential in the user-centered design process (Maguire, 2001).

Manufacturer of interactive surfaces, for example, are not blind to the importance of prototyping. For instance, the latest model of the Microsoft/Samsung Surface²⁹ tabletop computer is equipped with the ability to recognize physical objects and provides a software framework to interact with them in a short time-frame. When placed on the Surface, an object's position and orientation are recognized and made available to the programmer.

26 <http://www.reactable.com/>

27 <http://www.disneystore.com/>

28 Photos (from left) © Bram de Jong, Jonathan Nalder. Reproduced under a CC BY-NC-ND 2.0 License <http://creativecommons.org/licenses/by-nc-nd/2.0/deed.en>

29 <http://www.samsunglfd.com/solution/sur40.do>

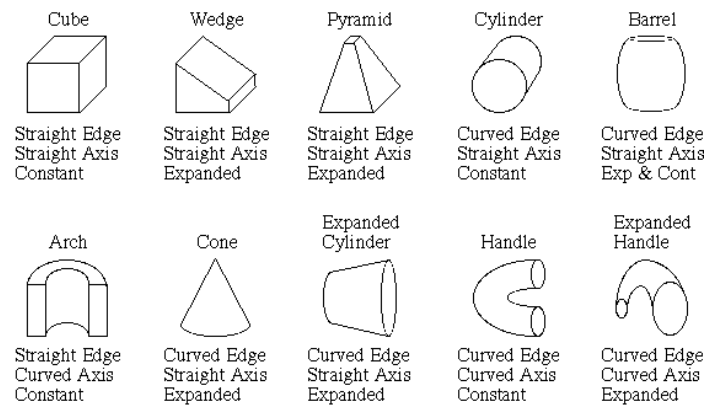

Figure 27. Simple geometrical forms as described in Biedermans' theory on object recognition (Biederman, 1987).³⁰

However, while these prototyping methods support explorations of responsive interactive behavior, they do not provide investigations into form factors in equal amounts. Therefore, we aimed at an approach that simultaneously allows exploration into interactivity and form factors (Wiethoff and Butz, 2010). Our goal was to develop a low-fidelity prototyping technique for TUIs that works with interactive surfaces. Physical objects would be the input device, while the surface would be the graphical and auditory output device for visuals.

In considering what such a toolkit might look like, we referred to Biedermans' theory of object recognition (Biederman, 1987). According to this theory, humans recognize different objects by separating them into geometrical forms, which he referred to as geometrical icons (GEONS), (see Figure 27). We considered it advantageous that the variety of objects exemplified in this framework were able to match Buxtons' sketch properties in that they have additional distinguishing features, i.e., *disposable*, *plentiful*, *quick to make* and *ambiguous* (Buxton, 2007). The latter was considered to be the most crucial characteristic in creating such a toolkit as the opportunity for open interpretation is a key advantage of low-fidelity methods, a point that was positively made in our survey on current interaction design practice, discussed earlier in section 3.3.

Furthermore, we searched for an opportunity that would support the quick and efficient replication of 3D low-fidelity artifacts and thus allow others to replicate and mimic our approach. One case we found ourselves returning to was

³⁰ Photo © by the referenced author

exemplified by Eisenberg et al. who created *Hypergami*, a toolkit that supports the mathematical craft of a variety of simple geometric objects via an online platform (Eisenberg, 2002), (Eisenberg et al., 2003). However, Eisenberg et al. aimed at producing objects resulting from geometric forms in general while we investigated objects that could be utilized as *graspable* control elements on interactive surfaces.

An additional approach that we considered was the replication of paper objects through, for example, commercial platforms such as *Pepakura*³¹, an online tool to share and replicate paper objects (see Figure 28).

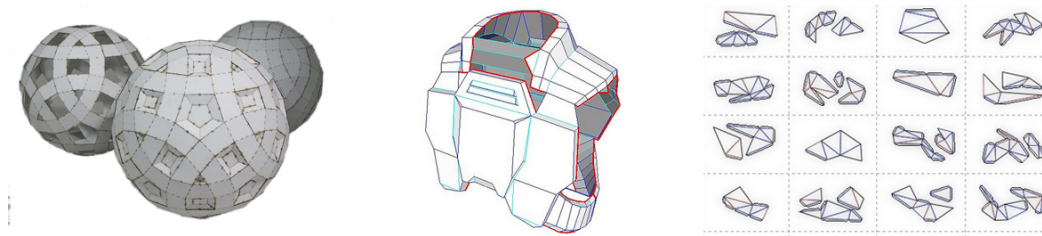

Figure 28. *Pepakura*, a platform for sharing and replicating user-generated 3D paper objects.³²

6.2 Physical Objects on Vision Based Surfaces

Paperbox is a three-dimensional prototyping toolkit that was meant to help developers of TUIs envision interaction concepts and to ease communication with potential users during the early phases of the design process. The toolkit consists of various geometric objects in three sizes. Their shapes are based on the previously mentioned theory of GEONS (Biederman, 1987) in order to provide enough basic shapes for the exploration of form factors. These form factors are, in the case of TUIs, strongly interconnected to the concept of object *affordances*, as discussed by Norman (Norman, 1999).

31 <http://www.tamasoft.co.jp/pepakura-en/>

32 Photos (from left) © Michael Vroegrop, Andrew Scott, Jeff Warren. Reproduced under a CC BY-NC-ND 2.0 License <http://creativecommons.org/licenses/by-nc-nd/2.0/deed.en>

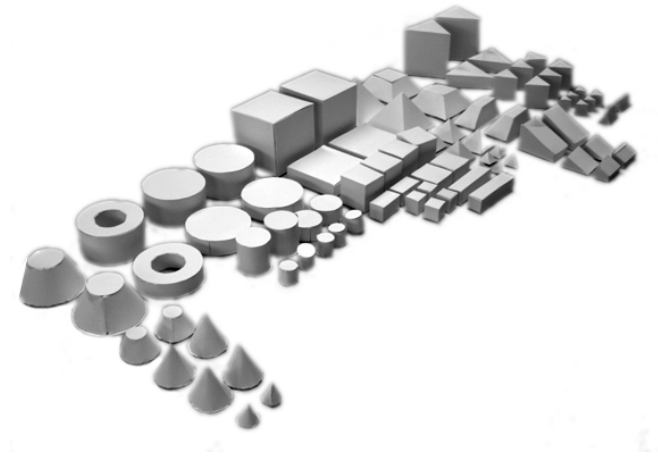

Figure 29. An initial version of *Paperbox*, a toolkit for the rapid exploration of form factors considering graspable interaction concepts in early process stages.³³

In our first attempt at *Paperbox*, we³⁴ created 90 different low-fidelity elements, made of 1.5 millimeter thick white cardboard (see Figure 29). We provided 30 individual object shapes in three sizes: small (1.5cm diameter), medium (3cm) and large (6cm) in order to provide different volumes. These elements can easily be attached to each other using magnetic tape for creating more complex and abstract forms of early TUI representations (see Figure 32).

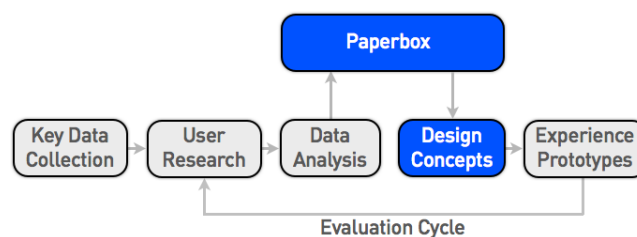

Figure 30. *Paperbox*, a toolkit intended to help designers exploring form factors of TUIs in process stages when considering alternative design concepts.

33 Photo © Julia Kufner

34 The scientific plural in this section refers to all persons involved in this research phase – namely Alexander Wiethoff and Julia Kufner.



In early formal and informal participatory design sessions, these objects can stimulate the *flow* of communication and provide insights into which physical appearance is the most appropriate representation for the attached digital behavior (Wiethoff et al., 2010).

In order to further substantiate our initial assumptions, we took *Paperbox* to a more formal setup and conducted an exploratory study in two phases.

6.3 Exploratory Study I

6.3.1. Participants and Setup

We investigated whether our approach could provide benefits for TUI design similar to the low-fidelity method of paper prototyping for graphical user interface (GUI) design. In the first exploratory pre-study we therefore aimed to consider the perceived advantage to participants of a tangible brainstorming method, using the toolkit to envision interaction concepts for TUIs on interactive surfaces (see Figures 26 & 31). One idea that arose during one such brainstorming session was subsequently implemented on a Microsoft Surface tabletop computer and served as contextual framework for a follow-up study phase.

To investigate what benefits a three-dimensional brainstorming medium could provide, we recruited twelve participants, (seven female, average age was 25 years). Six participants were students of media informatics, one was a student of art and multimedia, two were students of pedagogics, one student of computer science, one was a research assistant and one was taking a Ph.D. in social psychology. They were divided into groups of three and asked to envision and discuss the physical properties and interaction behavior of a TUI in two applications, one for browsing photos and one for editing images. Both were meant to be implemented on the *Surface*. Each session lasted 15 minutes and was conducted using different ideation media. In one session, the participants used *Paperbox* to express their ideas and visions, in the other they used Post-It¹³⁵ notes as a brainstorming tool.



Figure 31. An initial version of *Paperbox* is being explored by participants for the fast creation of simple geometrical shapes to explore form factors of TUIs and express their ideas more easily.³⁶

6.3.2. Data and Analysis

Tasks and methods were assigned to the groups via a 2 x 2 Latin square. After four complete runs with all groups, using a within-subjects design, the participants were given a questionnaire consisting of a five-point Likert scale questions (1 meaning *strongly disagree* to 5 meaning *strongly agree*) combined with open questions comparing the perceived communicational aspects of both methods. All sessions were video-taped for analysis, and additional photographs of the setup were taken.

6.3.3. Findings of the Brainstorming Session

The teams came up with a variety of ideas for the given design context. Some of the early interaction concepts that were expressed with the aid of the toolkit are depicted in Figure 32. One team, for example, imagined objects that would be stacked atop each other and allow for different interactions using a time-based interface (see Figure 32, left bottom). By extension, different objects would represent and affect different time units. The larger object, stacked on the bottom of the TUI, would allow the browsing of years, the next object up would affect months, days, and smaller units of time so as to quickly give the user direct access to stored albums and individual images without having to navigate sub-menus.

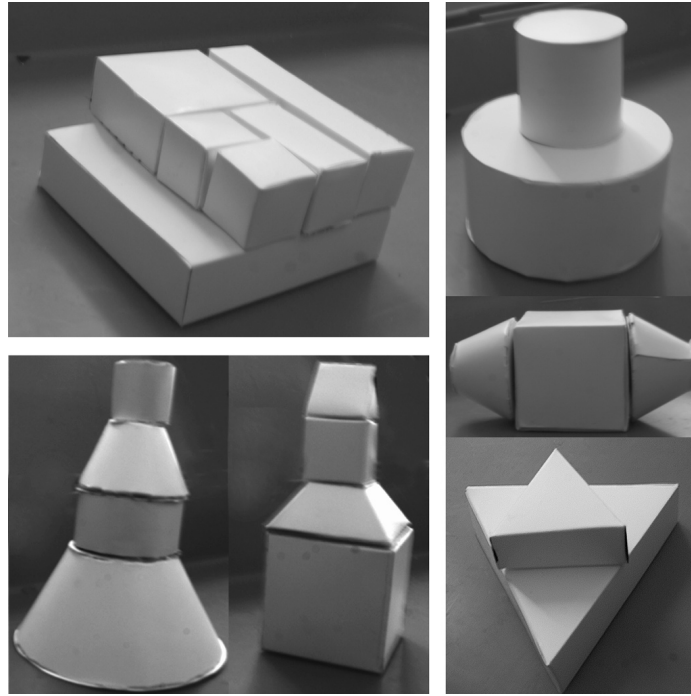

Figure 32. Early instantiations of TUIs for a photo application expressed through the aid of Paperbox.³⁷

Another interaction design idea considered by two teams involved having detachable objects that could individually be used for different purposes (see Figure 32, right top and bottom). They imagined that one object would remain on the interactive surface and the other, smaller, object could be removed and taken with the user, and could then act as data storage or a physical transmitter of selected images to other devices in other places (e.g., public displays). An additional idea included an object that would act as a *playhead* on a digital time line (see Figure 32, right middle). Small objects would be detachable and serve as constraints for an envisioned digital timeline while the bigger object would move through different time periods by being moved along the *time-line* like a big slider (see Figure 34). Some of these ideas were subsequently implemented on the Microsoft Surface 1.0 and served as means for a consecutive study setup (see Figure 34).

Considering the expected *communicational benefits* of graspable low-fidelity objects, we learned during this study that the tangibility of the paper objects provided the advantage of *stimulating communication* (mode=4) and allowed the participants to *express* and *visualize* (mode=5) ideas for TUIs on interactive surfaces more quickly than when using other, less physical, means (see Figure 33).

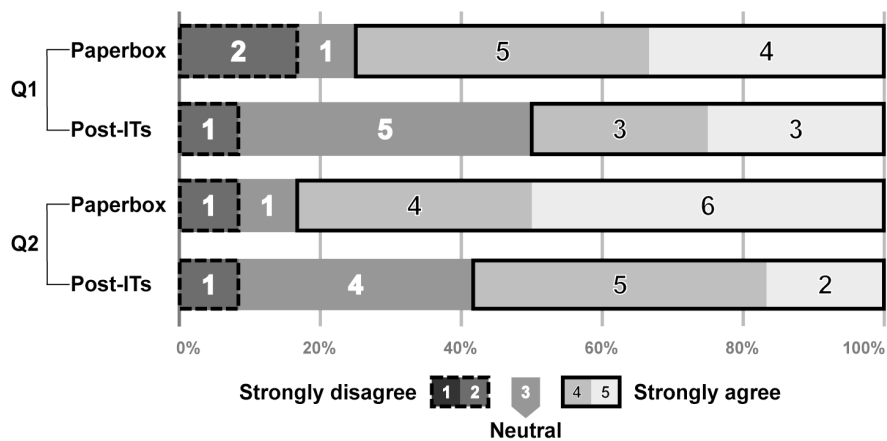

Figure 33. Results to the questions (Q1) : “The method facilitates communication” and (Q2) : “The method was suitable to express our ideas”

6.4 Exploratory Study II

6.4.1. Participants and Setup

In the second phase, we interacted with the participants to obtain anecdotes and statements that would further elucidate which aspects of the TUI physical representations struck a chord with them. We conducted two similar studies, each using six participants. The participants in these setups had an average age of 26 years. Eight of them were computer science students, and four were professionals: one psychologist, one with a background in computer science, one in electrical engineering and one research assistant from media informatics. Each participant was instructed as follows: First, we gave a 5 minute introduction and explained that the task at hand involved browsing through a large image collection with the aid of TUIs provided by *Paperbox*.

The prototype was implemented at a mixed-fidelity, meaning that the digital representations were fully interactive, while the physical artifacts from *Paperbox* remained low-fidelity. While implementing the digital elements on the *Surface*, we explicitly left out design elements such as colors, specific fonts or shading and focused purely on the system's functionality. The contextual framework of a photo browsing task was chosen because issues of finding the *right* form factor provided a good starting point (Hilliges et al., 2007): The design process in this project supported only investigations on one physical artifacts and lead to the discussion of a parallel exploration on both form factors and interactivity in a subsequent setup.

The participants interacted with the toolkit using a purpose-built software prototype for an application on the *Surface*. We divided the photo-browsing task into smaller sub-tasks, like storing images in an object, selecting a time period, etc. (see Figure 34). Within each sub-task, the participants were to choose whatever objects from *Paperbox* they would consider to *suit* the interconnected digital behavior.

Each time a user chose an object from the toolkit, a removable marker was attached underneath, thus enabling the manipulation of digital content on the *Surface* without compromising the plain object appearance beforehand. After users performed the sub-tasks, we discussed the reasons for their object choices and how they had interacted with them. All participants were recorded on video, and the content was subsequently transcribed.



Figure 34. Designing a photo browsing application using *Paperbox* to explore variations of form factors in participatory design sessions.³⁸

6.4.1. Data and Analysis

This discussion was supported by two questionnaires, each consisting of open questions combined with five-point Likert scale questions. Each session lasted 30 minutes in total. Qualitative analyses were performed using a coding scheme for the gathered multimedia content, with a focus on the *points of discussion* (meta theme): the statements gleaned from these transcripts were grouped according to a researcher-denoted lower level of sub-concepts such as *associations* and *functionality*. The following anecdotes extracted from these sessions are exemplary of the four hours of video documentation.

6.4.2. Findings

In the first sub-task, the participants were asked to define physical properties for a photo storage object that also served as an interactive device:

Associations

The main discussion of the eight participants in the first sub-task revolved around the possibility that the shape might suggest clues to the digital representation. For example: “It should look like a photo album, not too abstract...”, one participant stated. On the other hand, two participants preferred *generic* objects without any reference to the coupled interface elements. While experimenting with different objects, one participant had the idea of using a souvenir from their last holiday as a storage object. Another participant found “... the idea of having multiple objects that represent my whole photo collection...” generally pleasing.

Within the second sub-task, participants were required to choose two objects as physical representations of a digital *time line*. When positioned on the digital surface, a digital UI element would appear between the artifacts and vary in time units according to the proximity of the objects (see Figure 34, left).

Often, tiny or handy objects were chosen for ergonomic reasons: “...It should be something you can easily grasp...” and “...I associate arrows with the triangle which give me the indication to... move the objects along the time line...” One participant explained: “I chose two cylinders. You could imagine the time line to be a film reel that I can unreel by rotating the cylinders.”

Functionality

In the third sub-task, subjects were told that they could *store* a photo selection, like an album from a specific event, in a TUI object. The object was also meant to be used as a digital *photo frame* independently from the tabletop computer.

Eight of the twelve participants rated the idea positively. However, two participants stated doubts: “I want to keep function and content in separate objects. Therefore I would prefer to have an additional content object,” stated one participant. Regarding the discussed *functionality*, the hybrid usage also provided a problem for most participants. Seven of the twelve preferred having tiny, ergonomic objects for the scrolling function on the *Surface*.

Another issue mentioned by four of the participants was the mobility form factors of the TUI. One participant suggested that a storage object that can be taken to a friend’s house to browse through pictures ought to be tiny enough to “...fit in every pocket...”, saying, “I find it (even) more important to have an object that I can take with me and carry around.”

One participant had the idea of a *ring-like* storage object. He imagined that the main interaction would be performed via rotation, in which the digital time line was arranged in a circle around the object. When used as a photo frame, photos could be displayed around the outer surface of the ring as a slide show. A detachable smaller object would be used for further interactions, such as simultaneously manipulating digital content on different layers. When using the object for scrolling on the time line, only the smaller object would be used. He said of his TUI, “In terms of privacy, the smaller display would be suitable as I can decide there which photos I want to present to my friends in full screen on the *Surface*,” and, “Additionally the smaller object fits anywhere...” To demonstrate his idea, he quickly took the appropriate objects from the toolkit and assembled an artifact, which later served as the focus for further discussion (see Figure 32, top right).

6.5 Summary

Looking at the findings of both study phases, we noted two things:

- (1) The use of *Paperbox* was received positively, as it fostered open discussions about the form factors necessary for a graspable interface. In the initial phase, we observed that participants were enabled to *better express* their ideas with the help of the physical objects than they had been when using a two-dimensional medium.
- (2) In the second phase, the toolkit supported communication with potential end-users, allowing for the discussion of certain aspects of a TUI, such as *associations* and *functionality*, and thus involving their ideas in the design process.

While the rigid nature of the objects might seem limiting, in some cases, however, they can suggest possible starting points for early TUI representations. In addition to the investigation of properties such as *object associations* and *functionality* of a TUI, *Paperbox* also allowed designers to investigate which elements of a hybrid physical/digital system on a tabletop computer should instead be manipulated with a *graspable* interface and which elements should simply utilize multi-touch input. Here, a toolkit like *Paperbox* can initiate and support the early discussions and fuel the ideation process with initial insights. The resulting artifacts can help designers gain insights from users and use them as a guide during the first project phases, thus saving time and money for otherwise costly high-fidelity representations.

Considering the perceived positive effects in both study phases, we recommend using low-fidelity prototyping tools in the design process of TUIs. We have suggested an extended user-centered design process utilizing our toolkit during the early development phases of a TUI, namely the ideation phase leading to design concepts (see Figures 32 & 34).

Classification

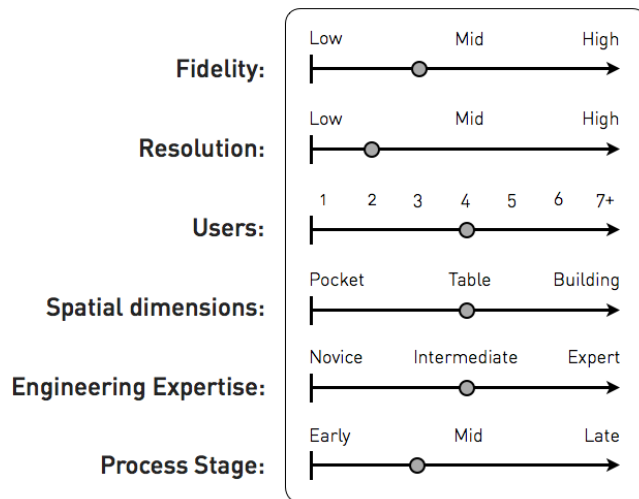

Figure 35. The classification of *Paperbox* as “business card” with relevant characteristic.

Referring to the visual overview depicted in Figure 35, we classify this implementation according to the following characteristics:

- The toolkit comprises a mixed-fidelity approach using low-fidelity physical artifacts and partly functional mid-fidelity digital artifacts.
- The resolution of the toolkit is kept at a lower level due to the nature of the clear geometric shapes provided for building physical objects. This circumstance constrains the number of design details the artifacts can incorporate. However, this matter should not be a substantial point of discussion during the intended design process stage anyway.
- We expect to use a maximum of four simultaneous users in participatory design sessions, a quantity that represents quite a maximum number of users interacting simultaneously with applications on digital tabletop computers.
- Physical TUI instantiations created with the toolkit, suggest that the form factor must be small to make the objects easily transportable. However, the current generation of vision based tabletop computers still requires transportation equipment due to the weight and size. Hence, the toolkit is categorized at mid levels on these matters.
- While the creation of the physical elements of the toolkit does not demand specialized training beforehand, the link to the digital representations does

demand some coding experience and is therefore represented at moderate levels of difficulty.

- *Paperbox* is intended to be used at early to mid-stages of the design process, when data resulting from initial user research has been analyzed and the design team is envisioning a variety of alternative design concepts (see Figures 32 & 34).

As has been pointed out before, in the classification visualization we provide a toolkit to be used at a design process stage in which the general direction of a project has already been decided (in our case a photo organizing and sharing platform), and a team of designers can start exploring interface elements on a more concrete application level (see Figure 34). The advantage of the paper objects is that the artifacts appear very generic, which speaks for their appropriateness as TUI representations in an early stage of development (Buxton, 2007).

However, this implementation is limited by the fact that the objects created with *Paperbox* only work with vision-based systems, and won't work on capacitive surfaces. As a result, developing physical prototypes for capacitive surfaces still requires a substantial amount of expertise in electronics (Yu et al., 2011), as well as the time and effort needed to physically model the tangibles and the electronics they contain. To address this difficulty, we sought out a method for transferring our approach to capacitive touch surfaces, presented in the following section.

6.6 Physical Objects on Capacitive Surfaces

Graspable tangibles are now also being explored in the context of the current generation of capacitive touch surfaces, such as the iPad and the Android tablets. Because the size and form factor of these devices is relatively new, early and low-fidelity prototyping of these TUIs is crucial to getting the right design. The problem is that it is difficult for the average designer to develop such physical prototypes. They require a substantial amount of time and effort to physically model the tangibles, and expertise in electronics to make them work.

Our solution contributes a low-fidelity prototyping approach that is time and cost effective, and that requires no electronics knowledge. First, we supply non-specialists with cardboard forms of *Paperbox* to create tangibles. Second, we have them draw lines on it via conductive ink, which makes their objects recognizable by the capacitive touch screen. They can then apply routine programming to recognize these tangibles and thus create multiple iterations of these tangibles over various designs (Wiethoff et al., 2012).



Figure 36. Sketching conductive ink on a cardboard object creates a tangible object recognized by a capacitive surface (Wiethoff et al., 2012).³⁹

Our method, which we call *Sketch-a-TUI* (Wiethoff et al., 2012), lets people rapidly construct lo-fi 3D paper objects that are recognized by a capacitive surface. For this to work, these paper objects must be quick to build and easily tracked by the surface. Our only assumptions are that people have purchased a conductive pen (see Figure 36), that they have a device with a capacitive surface such as an iPad, and that they have some coding expertise on that device.

³⁹ Photo © Doris Hausen

6.6.1. Tracking

Capacitive surfaces recognize changes in the capacitive field above the surface of the screen. Modern capacitive touch screens track these changes, and are thus able to sense the touch of one or multiple fingers. Using variants of this idea, it is possible to track physical objects placed atop the capacitive surface, either through passive conductors (Kratz et al., 2011) or active electronics embedded in the physical artifact (Patten et al., 2002), (Yu et al., 2011). Unfortunately, these methods are not appropriate for low-fidelity prototyping by non-specialists, as they require knowledge of electronics to create the conductors.

Our endeavor contributes a new method that lets non-specialists create recognizable physical objects simply by drawing lines on them using conductive ink (see Figure 36). Various commercial pens are available that use conductive ink; they are usually used for repairing circuitry on a circuit board. We employed these pens to let end-users draw a conductive line (with a blob-like endpoint) from the top of an object to its bottom (see Figure 39); only the blobs are seen by the surface, as the lines are too thin to be recognized. When a person holds the object, his or her hand touches the blobs on the top. The conductive ink then transmits the body's capacitive charge from the top of the tangible object towards the bottom, namely the face of the tangible that is in contact with the capacitive surface (see Figure 37).

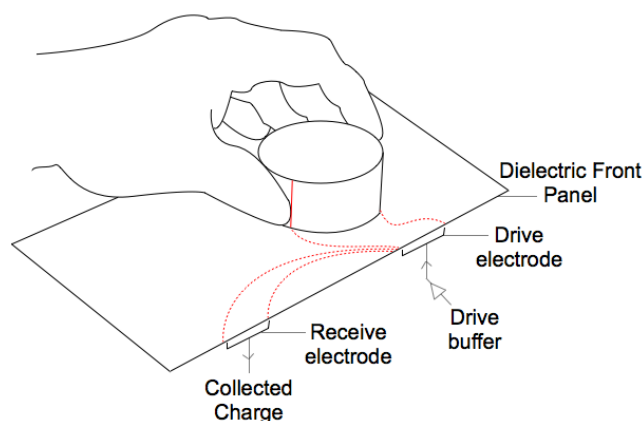

Figure 37. Schematic overview of how the user's capacitive charge is forwarded to the sensing grid of a projected touch-screen device through the conductive lines on the outer shell of the tangible.

The sensing grid of the capacitive screen device ‘sees’ the blobs at the end of the bottom lines as touch signals. We used multiple ink lines per object that lead to different blob-like end-points (see Figures 38 & 39). The surface's software is then able to differentiate between objects by taking the spatial configuration of the end points into account. In the simplest case, there are two end-points per object and the distance between the end-points is identified with the object. Based on the distance between these blobs (the touch points seen by the surface) the device eventually produces corresponding forms of interactive behavior.

Distinguishing between finger and TUI touches is done by checking if there is a constant distance between touch points (as produced by the TUI) vs. a single touch point (as produced by a finger) vs. changing distances between multiple touch points (as produced for example in a pinch-to-zoom gesture).

6.6.2. Creating Tangibles

A bottleneck in prototyping TUIs is the actual construction of the 3D objects. To mitigate this difficulty, we extended the *Paperbox* toolkit to work on capacitive devices: *Sketch-a-TUI* provides prototypers with a variety of matching templates (see Figure 38) that let them create various 3D shapes out of thin cardboard (e.g., cubes, pyramids, cylinders).

Marks printed on the template show where conductive ink lines could be drawn (e.g., Figure 36). The only skills required are cutting, folding, gluing and tracing lines. To create a tangible, the designer folds and glues the template into a shape, and then sketches the conductive ink marks on its outer shell to make it recognizable by a capacitive screen.

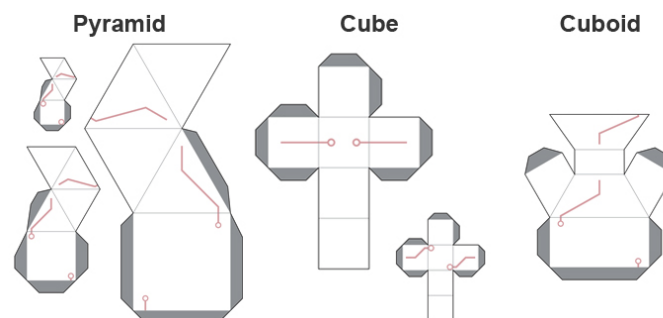

Figure 38. Example templates of paper objects. They collectively serve as inexpensive building blocks for creating a variety of TUI representations (Wiethoff et al. 2012).

The use of this toolkit is only constrained by the fact that the sketched conductive ink marks have to end at the side(s) of the object used to touch the surface (see Figure 37), and that the marks have to be above the minimum detectable distance and size in order to be safely detectable.

For example, different lines can be drawn on different sides, connecting to contacts at different distances; this means that different sides of an object can be distinguished as well. Alternately, the prototype can use three or more contact points per object to create recognizable 3D shapes that are easily distinguished from each other. Of course, designers are not restricted to these suggested conductive ink lines or the provided cardboard shapes. The presented technique works on any material to which conductive ink sticks.

Based on our own experiences with capacitive devices, the contacts on the bottom need to have a minimal size of about 5 x 5mm and a minimal distance of about 5mm. This is because tablet devices are currently optimized for detecting fingers on the surface. The precise minimum values depend on the device used. An example of what acceptable contacts look like is shown in Figures 36 and 39. Overall, our approach makes it easy for an end-user to create and experiment with different physical forms, as well as different layouts of the conductive ink. It is possible for different forms of digital functionality to be “sketched” onto the cardboard artifact (Wiethoff et al., 2012).

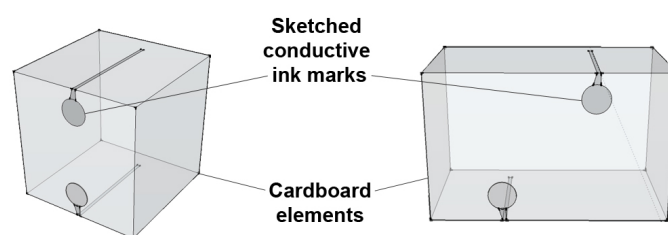

Figure 39. Through varying spatial configurations of conductive areas on the bottom of the cardboard elements, it is possible to differentiate between them (Wiethoff et al., 2012).

6.6.3. Coding

The final prototyping step does demand coding expertise, in which the designer uses the programming or scripting environment of their choice to prototype interactive behaviors in response to the recognized objects and the manner in which they are being manipulated. At this stage, we did not provide a software API for recognizing the touch points and/or for discriminating between objects by the distance between those points, or the orientation of that object. This is because (a) we wished to remain agnostic to the actual device and its programming environment, and (b) it is a fairly routine programming exercise to recognize two touch events, measure the distance between them, use that to identify an object, and calculate the orientation of that object based on the angle of the connecting line relative to the surface. Still, an API to simplify even this step could easily be developed by ourselves or by others. In use, the cardboard objects can be positioned on any interactive screen with capacitive sensing technology that allows multiple touch points (e.g., Android tablet, Apple iPad). Using a range of development tools, the prototype can then design and test early functional behavior based on how these objects are manipulated by the end user (Wiethoff et al., 2012).

6.6.4. Benefits of Sketch-a-TUI

To sum up, we see the following benefits of our approach:

- Low cost.
- Integration of digital functionality into passive artifacts.
- Fast and easy reproducibility.
- Rapid way to prototype early explorations of tangible interactions.
- No additional electronic components or batteries needed.
- Works with a wide range of off-the-shelf technologies.
- Enables collaborative design with teams including non-experts.

6.6.5. Experiences

We tested and explored the technical feasibility of this approach. Our equipment was all off the shelf: a conductive pen⁴⁰; standard 1.5 mm thick white non coated cardboard for our tangibles; an Apple iPad (version 1) as the capacitive surface; and the XCode IDE for iOS as our coding platform. We created five basic objects from the templates (see Figure 40, which shows them in use with an iPad), sized by the dimensions in Table 2. We then sketched lines of conductive ink onto the opposite sides of each of them as suggested by the template, each with different contact distances as listed in Table 2.

We developed code that distinguished between these cardboard objects by the different spacing between the forwarded touch events, and associated every object with an identifying number (Wiethoff et al., 2012).

Shape	Diameter	Height	Contact
Cube	40	40	35
Cylinder	35	40	30
Octagon	8	17	15
Pyramid	40	40	20
Octagon on Cube	10,28	40	25

Table 2. Specifications of five shapes used for initial testings (Wiethoff et al., 2012).

We then implemented a simple software application, written in Objective-C in the XCode IDE, that calculated the distance between two touch points and compared it with predefined ranges. Building one object took approximately 20 minutes. Occasionally, an object did not trigger the intended reaction; this was usually the result of inadequate ink. Repainting the conductive ink lines remedied these cases. In one of our test prototypes, a user held one of the five objects on the iPad.

A pie menu appeared immediately underneath, while its size (between 3 and 6 cm in diameter) and color were unique for each of the five objects (see Figure 40).

⁴⁰Standard Tip CW2200STP by Circuitworks



Figure 40. A working Sketch-A-TUI prototype showing the graphics it is controlling on an iPad (Wiethoff et al., 2012).⁴¹

When the objects were rotated clockwise or anticlockwise on the screen, whatever circular sector of the pie menu had been passed was highlighted yellow. Also displayed on the screen were the object ID and a number showing the object's relative rotation direction when rotated.

6.6.6. Limitations

Technical limitations of this approach include the fairly limited number of contact points that current multi-touch screens can distinguish at any one time. For example, the iPad we used can only distinguish ten contact points at once. This limits the simultaneous presence of tangible objects to five, assuming each has only two contact points. On the other hand, the small size of the iPad screen would make more than a few objects impractical anyway. Another limitation is that the touch points of the objects are only sensed while the user holds the object. This means that we cannot distinguish an object lifted off the surface from simply lifting the fingers off an object that remains on the surface (Wiethoff et al., 2012).

41 Photo © Hanna Schneider

6.6.7. Extensions

Different sides of a 3D cardboard object can be associated with different contact points on the bottom, so that different behavior can result depending on how the user touches an object. This extension is more flexible than a fixed one-tone mapping of physical objects to virtual behavior. For example, grabbing the object in one place could activate a pie menu to select various options, whereas grabbing another part could activate a slider to continuously adjust some previously selected parameter.

A complete interaction language could be thus defined very simply. Additionally, larger objects could be assembled of simpler objects stacked atop of each other. The relative rotation or position of these sub-objects could activate different contact lines leading from one sub-object to another and eventually to contact points on the capacitive screen (Wiethoff et al., 2012).

6.7 Industrial Use Case

6.7.1. Context

To investigate the capabilities of our implementation, we took *Sktech-a-TUI* to a more formal setup within an industrial context:

We⁴² were approached by a large manufacturer of consumer electronics to help them with the development of one of their future products and its new interface solutions. The company's design team was confronted with the challenge of developing a physical interface atop a thin film transistor (TFT) display.

Based on our initial observations in their design studio we learned that the way they would normally approach creating a new interface solution in this context would have been to create a variety of 3D renderings. After creating variations of the design concepts presented in this format, the concepts would undergo an internal presentation and decision-making process. Next they would determine which of the generated concepts would be turned into high-fidelity prototypes. To do this, they would consult a model-maker and receive a physical, non interactive version of their favored design.

⁴² The scientific plural in this section refers to all persons involved in this research phase – namely Alexander Wiethoff and Hanna Schneider.

They then would add additional electronic components to emulate interactivity, but only in a very rudimentary way.

We suggested that they make use of our toolkit as a starting point for the design process: By using our toolkit, the designers would (a) brainstorm on various interface concepts with the aid of *Sketch-a-TUI* and (b) physically express the ideas early in the process while simultaneously exploring form factors and interactivity. We suggested that the design team select their favored interaction concept and create representations on higher fidelity levels while contemporaneously conducting tests with users to improve the concept and the usability of the interface.

We took this setting as an opportunity to reflect on an extended interaction design process while observing our toolkit *in action*: We undertook a study setup that would investigate the use of our implementation from three different view points.

- (1) The designers were observed via expert interview studies at dedicated points in the design process (e.g., when the prototype was transferred to a higher fidelity). Further, we questioned them about their experiences with the suggested process extensions and at which points they faced limitations.
- (2) Potential users of the interface underwent usability inspections: we invited test-subjects to judge if our implementation could be also used for testing sessions.
- (3) Our personal observations of the design process were recorded via diary studies.

6.8 Expert Interviews I

6.8.1. Setup and Participants

The expert interviews were undertaken at four points during the design process. Following an iterative design process the fidelity of the prototype in question was increased towards a high-fidelity representation (see Figure 42).

We individually interviewed seven industrial designers; all were employees of the the same design studio (three female, average age was 34 years). Four were employed as senior industrial designers, two were graphic designers and one was a design manager. Two of the participants were junior industrial designers.

Each session lasted 45 minutes in total and was video-taped for later analysis.

6.8.2. Data and Analysis

The observations were supported by two questionnaires consisting of open questions and questions answered on five-point Likert scales. Following a semi-structured retrospective interview on what they thought of the design process, the participants were asked to rate the *suitability* of a given prototype, created with *Sketch-a-TUI* for certain (design) activities on a five-point Likert scale, ranging from 1 meaning “strongly disagree” to 5 meaning “strongly agree”. We structured the answer/response scheme in this setup to investigate the interviewed designers' evaluations of our implementation, specifically in consideration of varied purposes and activities during the design process.

The questions we asked therefore addressed their experiences with the toolkit (see Figure 41) and their perception of the created prototypes' *suitability* for:

- Brainstorming.
- Exploring variations of an interaction concept.
- Explorations on form factors.
- Investigating materiality aspects.
- Judging industrial design matters.
- Investigating the users' experiences (UX).
- Presentation purposes.
- Usability tests.

6.8.1. Findings

In analyzing the completed questionnaires, we discovered that the majority of the interviewed participants considered *Sketch-a-TUI* to be a “...valuable extension...” for their internal design processes. The majority of the participants (six of seven) appreciated the ability to create a variety of interactive prototypes rapidly in a difficult design context (see Figure 41).

The data also indicates that while the majority of the designers considered *Sketch-a-TUI* to be a brainstorming support tool that allowed for the exploration of interaction concepts as well as form factors in early stages of development, they also suggested that our implementation would only be useful for initial explorations during the *brainstorming* and *concept development* phases. They

probably would not, for example, use the toolkit for presentation purposes (see Figure 41). Instead, the majority (six of seven) of the interviewees stated that they would prefer to move on to a higher fidelity once a design concept has been agreed upon. In the following section we give a summary on the more important points in greater detail.

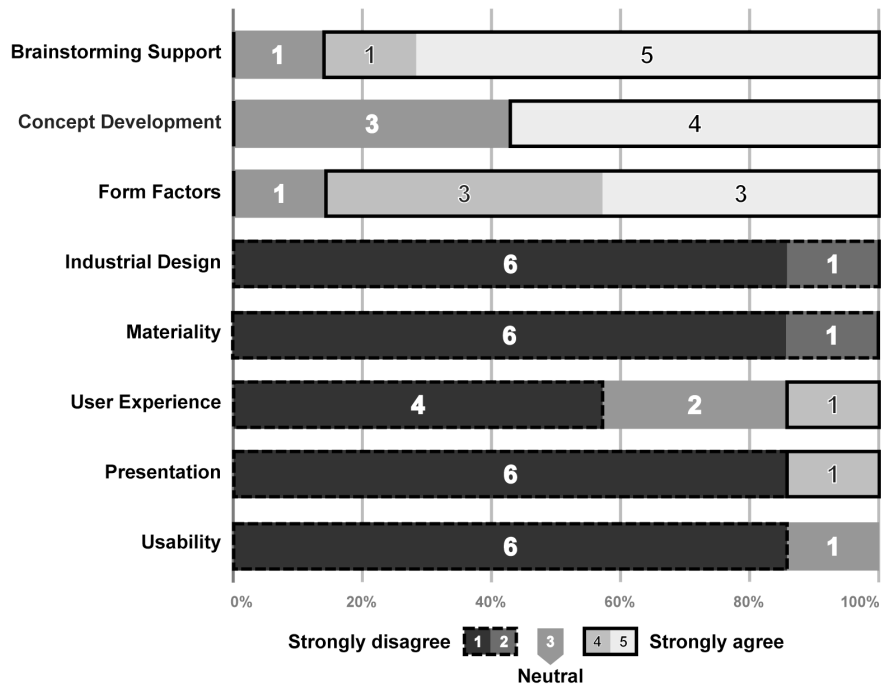

Figure 41. The results of the Likert scale questionnaire on the extent to which the interviewed designers would consider the use of *Sketch-a-TUI* for different purposes during the design process.

Brainstorming and Concept Development

For the first two questions, we wanted to investigate the suitability of *Sketch-a-TUI* for early process activities such as brainstorming and concept development. We considered these two idioms separately as we tend to think of the brainstorming phase as a stadium in which *any* idea may be valid, while ideas discussed in the concept development phase undergo a more systematic, strategic filter to evaluate the initially generated ideas and turn them into realistic concepts on an application level.

As to the suitability of the *Sketch-a-TUI* to brainstorming, five out of seven participants opted for “strongly agree” (see Figure 41). One designer simply “agreed” and the design manager remained “neutral” on this question. As

recorded in a number of answers to the open questions and in our diary, the majority of participants stated that a prototype created with the toolkit was perceived as being *suitable* for these purposes.

A similarly positive response frequency was received when we asked the participants if they would consider the toolkit to be a means of exploring interaction design concepts on a more detailed application level, as is represented in Figure 41.

Form Factors

During the design process, we aimed at supporting the core design activity of early form factor exploration. Six out of seven participants expressed a positive outlook (three “strongly agreed” while another three simply “agreed”) on the toolkit's suitability to explore the physical shape of the control element (see Figure 41). One participant “disagreed” and stated that, in his opinion, this would have only been possible in a “...very rudimentary way.”

However, in an additional question regarding the suitability of *Sketch-a-TUI* for exploring form factors, all interviewed participants “agreed” (two) or “strongly agreed” (five) that the low-fidelity prototype created with the toolkit was perceived as being appropriate to this task (see Figure 41).

Materiality

Reflection on materiality is a core activity within industrial design practices. While we explicitly highlighted the exclusion of these aspects during early phases of the process, as they would provoke unwanted feedback, we wanted to know if the participants would consider the usefulness of the toolkit for this purpose at any given point during the whole process (e.g., in later phases).

We received very distinct feedback regarding this matter as six participants “strongly disagreed” and one “disagreed” that the prototypes created with the toolkit would stimulate ideas regarding the materiality of a graspable control element. They attributed this lack of suitability to the ambiguous nature of the toolkit, a nature which would not support *committal* design decisions (see Figure 41).

User Experience

A point necessary for to users' acceptance of a new system lies in the interface support received by the user experience goals as understood by Hassenzahl and Tractinsky (Hassenzahl and Tractinsky, 2006). We wanted to know if the interviewed designers thought that the toolkit would support the initial decision-making phase in this realm. The feedback concerning this matter was less explicit than other aspects have been (take “presentation” or “materiality,” for instance), as four out of seven designers “strongly disagreed” that a prototype

created using *Sketch-a-TUI* would support explorations in this realm, while one participant “agreed” and two remained “neutral” (see Figure 41).

Presentation

Prototype creation, within large companies, as in our context, is mainly undertaken to introduce other people (e.g., product managers, CEOs, etc.) to the design concept in the setting of a formal presentation. As we observed, the overall work goal of the design team was to present their concepts to product managers and get them approved, thus turning their ideas into marketable products.

In the light of these goals, we asked the participants if they would use the created prototypes in these presentations. As Figure 41 indicated, six of seven participants “strongly disagreed” and did not consider *Sketch-a-TUI* to be suitable for presentation purposes, and only one participant “agreed.” The majority of the interviewed designers would use the *Sketch-a-TUI* prototype (five of seven) “...only within the developing team in order to make early decisions...” One participant expressed in the additional comments section further suggested that, “...they (the created prototypes) look too premature to present them...”

Usability

In the final question of the expert interview study we focused our attention on the probability of the participants using the prototyping toolkit for early usability measurements.

Six out of seven participants “strongly disagreed” and one “disagreed” that the resulting prototypes would be suitable for usability inspections (see Figure 41). They assumed that invited users would not have the necessary ability to “...see beyond the cardboard...” and that the prototypes would lack the appropriate accurateness for testing purposes. In their opinion users would “...rate the systems' usability negatively as a consequence...”

6.8.2. Summary

The additional feedback we received from this session is summarized in the following bullet lists. Direct feedback to the open questions mainly addressed the benefits and limitations of the toolkit:

Benefits:

- Fast, cheap and easy to build.
- Capable of visualizing the interface.
- Helpful for initial prototyping.
- Well suited as a brainstorming-tool.
- Excludes trivial (design) details.

Limitations:

- Not presentable due to unfinished (low-fidelity) appearance.
- Limited suitability for usability studies.
- Not very accurate (precision is crucial to measure user experience).

Of course these, and the results gathered in our previous studies with *Paperbox*, reflect an immediate and novel use of our implementations as extensions for the design process. Hence, an extended use of the proposed toolkit under similar conditions can lead to (a) a push towards its further development and use in other contexts, (b) a partial or complete abandonment of the proposed implementations, (c) a better understanding of a project's prospects and limitations, or (d) a completely unexpected adaptation and utilization. In aiming to discover these opportunities through further analysis, in the final parts of this thesis, we lay out the next steps for our research.

However, despite these promising initial findings gathered in the field we wondered if the envisioned interaction concepts, prototyped with *Sketch-a-TUI*, would allow usability measurements. Initial answers in this setting were comprised mainly of participant estimates and did not encompass first hand experiences. We therefore undertook a formal usability inspection using prototypes created with the aid of our toolkit and compared the results with prototypes on higher fidelities (see Figure 42).

6.9 Usability Inspection

The exploratory usability tests we conducted with potential end users were aimed at investigating the feasibility and practicality of usability tests with low-fidelity artifacts created with *Sketch-a-TUI*. More specifically, we examined whether the artifacts would deliver data that could help in improving usability.

To do this we adopted three prototypes of different fidelity levels as our testing mediums (see Figure 42). The coupled digital interface representation incorporated four value counters ranging from 0-9 that could be selected by tapping on the physical interface in a spot next to the displayed value (see Figure 42, left). Once a value counter was selected it would respond to the rotation of the TUI by increasing the value through clockwise rotation and decreasing the displayed value through anti-clockwise rotation. The experiment was conducted using a between-subject design with 36 participants (twelve female, average age was 25 years) to avoid bias. All participants were students of the LMU Munich from different disciplines.

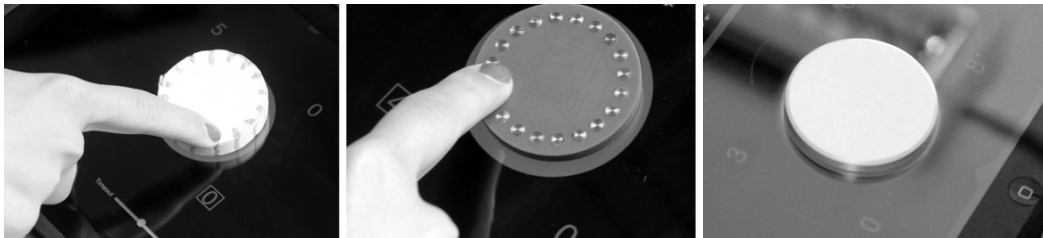

Figure 42. Prototypes of three fidelity levels as a means for conducting usability studies: prototype (1), created with cardboard and conductive ink (left), a functional mid-fidelity prototype (2) (middle) and a glazed high-fidelity prototype (3) (right).⁴³

The individual test sessions were conducted as follows:

First, the participants received a 5-minute introduction to (a) the overall context of the study and (b) a brief introduction to the prototypes' features.

Next the participants were asked to carry out two tasks, both of which were considered to be *typical use cases* for the product line in question, and which were suggested by the industrial partner.

43 Photos © Hanna Schneider

Task 1: Place the TUI on a capacitive sensing device (here iPad, version 1), then set the appearing pie menu to value “9” through clockwise rotation, starting from value “0”.

Task 2: Set the value of the first interface representation to “3”, then switch to another value counter and set the value of the second counter to “8”.

6.9.1. Data and Analysis

After the participants had performed the two tasks using one out of three randomly assigned prototypes, they were asked to fill out a questionnaire on their usability satisfaction consisting of seven-point Likert scale questions, ranging from “1” meaning “strongly disagree,” to “7” meaning “strongly agree” combined with additional open questions. The questionnaire was based on the psychometric evaluation for computer usability studies, initially presented by Lewis (Lewis, 1991).

To observe the testing sessions we used the human behavior research system *Observer XT 10.5*⁴⁴. We designed a coding scheme using this system to track task completion time and communication of the participants.

The following aspects were observed and documented during the study:

- Time for fulfilling Task 1.
- Time for fulfilling Task 2.
- Feedback referring to the different prototypes.
- Ratings in the After-Scenario-Questionnaire.

All participants were additionally recorded on video for later analysis, and photographs of the setup were taken during the study.

6.9.2. Findings

We wanted to investigate time-measurement, particularly whether or not the prototypes created with the toolkit could be used for the accomplishment of a given task in a *reasonable* amount of time. To investigate what time-frame the participants perceived as *reasonable* we employed a Likert scale question in the follow-up questionnaire.

44 <http://www.noldus.com/human-behavior-research/products/2/the-observer-xt>

The prototypes created with *Sketch-a-TUI* were limited in their construction, especially compared to their mid- and high-fidelity counterparts, and thus their performances were expected to be less accurate. The toolkit-created prototype's main shortcoming was that it did not have a fixated rotation axis as the other, more refined versions did, included in prototype 2 and 3.

As Figure 43 exemplifies, the *Sketch-a-TUI* prototype confirmed our initial assumptions and its performance was viewed as inferior in Task 1 with 8.65 seconds on average, (SD=2.71sec) while prototype 2 had 6.56 seconds on average (SD=3.18sec) and prototype 3 had 6.41 seconds on average (SD=3.22sec). The difference was the result of the aforementioned limited accurateness of the paper object.

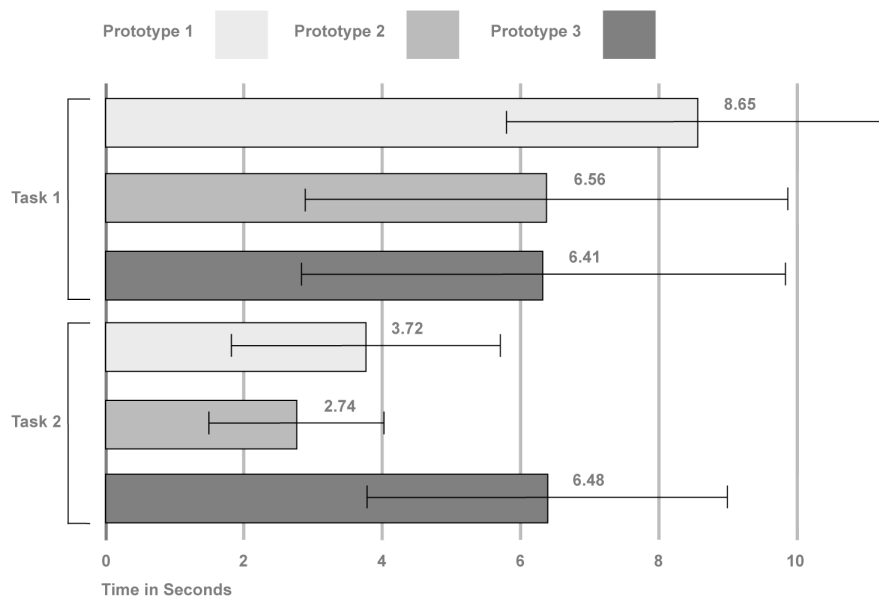

Figure 43. Results of the explorative usability study incorporating time measurements for completing Tasks 1 and 2.

However, answers provided in the follow up questionnaire did not express a negative perception of the interaction experience (see Figure 44). In fact, the prototype in question received positive response frequencies (mode=6) at a rate similar to the other versions (see Figure 44). Prototypes 2 and 3 received similar values accomplishing Task 1 (see Figure 43), which was a result of their similar

technical configuration: the attached rotation mechanism allowed for a very precise rotation.

It took the participants an average of 3.72 seconds (SD=1.80sec) to accomplish Task 2 using the low-fidelity prototype created with the toolkit. The mid-fidelity prototype performed best as it took the participants an average of 2.74 seconds (SD=1.39sec) to complete, while the positive response frequencies were additionally the highest in the follow-up questionnaire (see Figure 44).

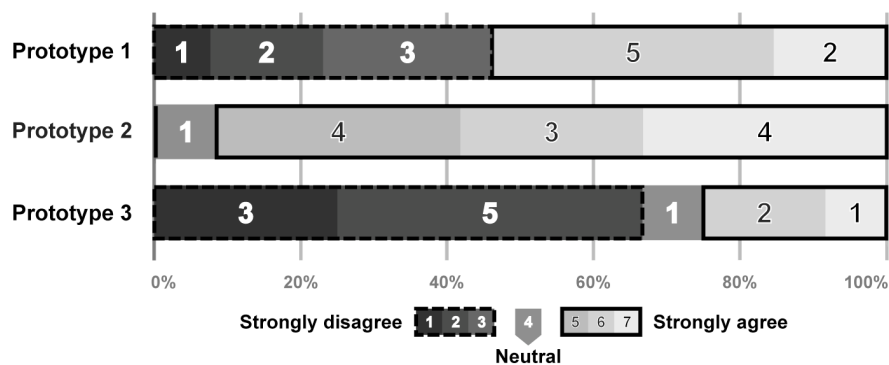

Figure 44. Response frequencies to the prompt “The physical prototype allowed me to accomplish the given tasks in a reasonable amount of time”

The high-fidelity prototype performed worst in this setting with an average task completion time of 6.48 seconds (SD=2.60sec), which was also a result of a technical limitation: the glazed paint decreased the conductivity slightly and caused difficulties in half of the experiments, particularly when the participants *switched* between different value counters. Users who did not apply a certain amount of pressure did not get immediate feedback and felt that the system did not respond correctly. This issue affected also the prototype's rating in the questionnaire, indicated by the low scores (mode=2) prototype 3 received, (see Figure 44).

Regarding the perceived *ease of use*, prototype 1 (mode=6) and 2 (mode=5 and 6) received higher values than prototype 3 (see Figure 45). The scores of prototype 1 reflects a disparity with the statements made in the expert interviews, in which the design team did not consider a *Sketch-a-TUI* prototype on this fidelity level to be suitable for conducting early usability tests. The large number of negative responses received by prototype 3 (mode=2) was again due to the aforementioned technical difficulties occurring only at one point during task 2.

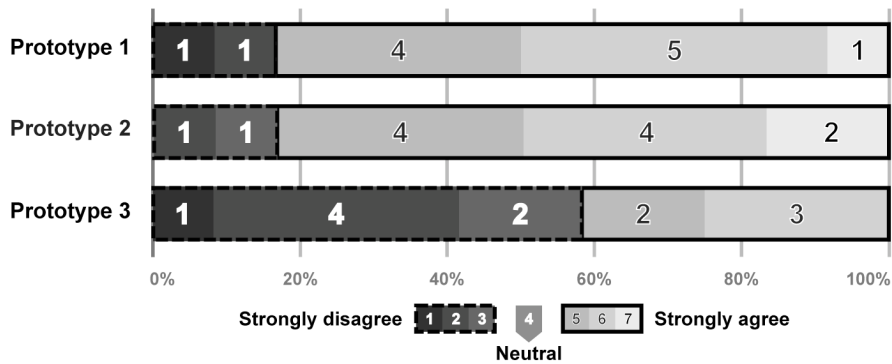

Figure 45. Response frequencies to the prompt “It was easy to accomplish the given task using the provided physical prototype.”

At the end of the questionnaire we asked how the participants perceived the overall usability of the proposed system and if the participants felt that the interface would provide enough information to accomplish the given tasks. All prototypes received more positive scores than negative.

These scores indicate that in all three conditions the users found that the overall interface provided *enough information* to accomplish the given tasks. The equal distribution of the scores (all prototypes received 7 scores in the range of 5-7) indicates that the participants expressed their experiences with the different prototypes in the two previous responses and did not deal with the interface concept per se, as in case of the final question.

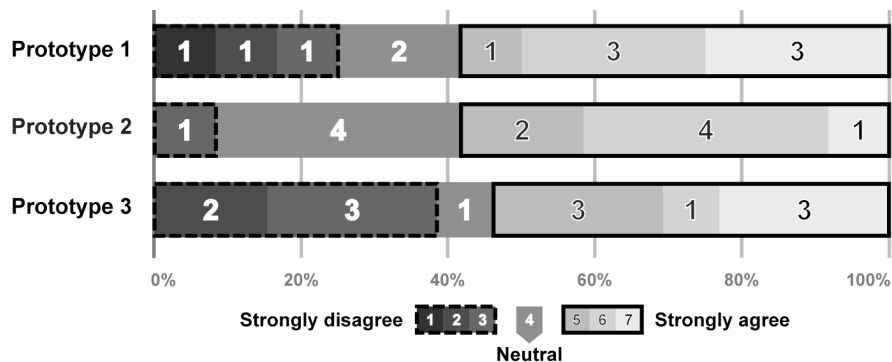

Figure 46. Response frequencies to the prompt “The physical prototype and the displayed graphical interface provided enough information to accomplish the given task”

6.9.3. Summary

This exploratory usability study confirmed our theory that even low-fidelity mockups made of paper and conductive ink can be used to detect usability issues. The prototypes created with the toolkit allowed users to accomplish given tasks despite delays owed to their construction, and performed relatively well when compared with their mid- and high-fidelity counterparts. The delays did not affect the interaction experience in a negative way.

As discussed earlier, the previously exemplified implementations still required coding experience to create interactivity. We believe this matter to be a clear limitation of our toolkit as it would prevent a quite large group of designers from working with our implementation. To solve this issue we considered designing an application that would allow also users with no programming skills to create interactive TUI mockups.

6.10 Sketch-a-TUI Application

To help designers build interactive instantiations with *Sketch-a-TUI* that did not require prior coding experience, we⁴⁵ created an application for the iPad using XCode 4 and the iOS 5 API.

6.10.1. Technical Details

The device we used (here Apple iPad, version 1) had a screen resolution of 768 x 1024 pixel. Our application analyzed two simultaneous touch events and measured their distances, as well as their absolute distances resulting from a calculation between the minimum distance (`minDistance`) and maximum distance (`maxDistance`), (see Figure 47).

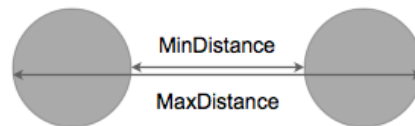

Figure 47. Two touch events and their minimum/maximum distances used to calculate their absolute distance.

Based on our initial experiments with the toolkit we found that the markers created with the aforementioned blob like end points would incorporate an absolute distance below 35 pixels. In the case of our initial experiment with the application, similar to the one discussed in section 6.4, the distance variation we experienced was less than 15 pixels. As a result we used a 20 pixel range for our application, providing more reliability by using a buffer of an additional five pixels. In our case the pixel density of the utilized device incorporated 132 pixels per inch (ppi), which lead to a realistic spatial range of 4 mm. Our application contained a feature for mapping the measured absolute distances within the 4mm range to an object which could consist of a physical artifact created with the toolkit (see Figure 40) or any other arbitrary object instrumented through the technique described in section 6.4.

⁴⁵ The scientific plural in this section refers to all persons involved in this research phase – namely Alexander Wiethoff and Fabius Steinberger.

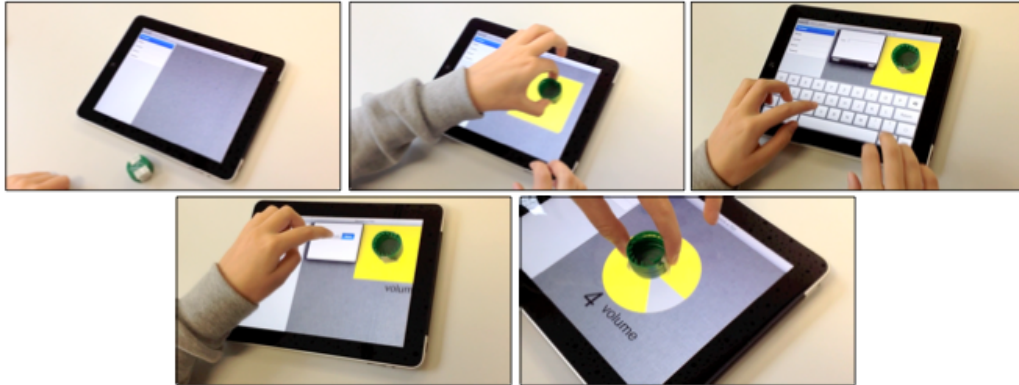

Figure 48. An iPad application allows users with no coding experience create tangible interactions and assign interactive behavior.⁴⁶

Once an object was placed on the device and *touched* on the conductive path, it would create a unique object ID (marker) that would support the recognition and differentiation of any physical object positioned atop the screen (see Figure 48).

6.10.2. Application Features

Besides the recognition and identification of physical objects, we considered the *end* of an interaction to be an important aspect of the application as it would be an odd experience for the users if, for example, an object had been removed from the screen and the corresponding graphical interface elements were still visible. Due to the technique of forwarding the users' body capacitive load to the end points of the conductive ink lines and thereby to the sensing grid of the device (see Figure 37), the surface cannot determine if an object has been removed from the screen or if merely the fingertips have been lifted off.

To address this issue, we equipped our application with a *timeout* that can be customized by the user. The *timeout* determines the amount of time the graphical interface representations are displayed before they fade out and disappear, responding to situations in which (a) the physical element is not in use anymore or (b) it has simply been removed from the screen.

⁴⁶ Photos © Fabius Steinberger

We further implemented a variety of additional features that allow the customization of the GUI components (see Figure 48):

- Text labels in different colors.
- Shapes in various sizes and forms.
- Control elements such as slides or knobs.
- Additional audio feedback.
- Object library with information on measured pixel distance.

6.11 Expert Interviews II

6.11.1. Goals

In order to investigate how senior level designers would respond to the previously discussed implementation, we enacted field studies in a variety of different situations: a large international design consultancy, a large IT company, and a game development company.

In this setting we aimed to explore how useful this circle of professionals would consider the *Sketch-a-TUI* application in the early stages of the physical interface design process. Furthermore, we wanted to know what benefits or limitations they would associate with using the toolkit in their work environment and what possible extensions they might find useful.

6.11.2. Setup and Participants

We selected the participants in this setup according to aspects like role, professional work experience, and the quality of feedback we received from previous interviews (see section 3.2). In this expert interview session we had four participating designers (two female, average age was 32 years) who had an average of seven years of professional work experience in their respective fields of expertise. Each participant was interviewed twice for 60-90 minutes. A semi-structured interview script was used to ensure that all the aspects we were colloquial to investigate were covered.

The expert interview sessions were structured as follows: First the participants were introduced to *Sketch-a-TUI* (average 10 min.), in which both the underlying concept and the physical artifacts, complete with the created application, were demonstrated. Next we introduced them to the interview script and used the

toolkit to strike up conversations for an imagined design case: a hybrid in-car touch interface. This topic was also currently being explored by one of our industrial partners in the automotive field (Wiethoff and Richter, 2011). All interviews were audio-recorded for later analysis, and additional photographs of the sessions were taken.

6.11.3. Data and Analysis

In analysing the recorded multimedia content, we relied on the open-coding scheme proposed by Corbin and Strauss (Corbin and Strauss, 2008).

After a initial round of transcribing the collected data, researcher-denoted concepts were formulated including *design activities*, used by creative professionals in their daily work environments. These design activities included concepts like a holistic high level data pointer (meta), *brainstorming*, *ideation*, and *communicational purposes* while *limitations and extensions* were thought of as the low level data pointers for these sub-concepts.

6.11.1. Findings

Brainstorming and Ideation

The first concept we identified during the data analysis was the consideration of *activity patterns* in which the interviewed participants thought of our toolkit as being a useful extension to their design process. All participants spoke positively of the early process phases such as ideation and brainstorming sessions. One interviewed designer appreciated the ambiguity and playfulness of the toolkit as an instrument supportive to brainstorming. One participant stated, “I consider this an ideation tool since it stimulated my mind and it did this in a very playful way, almost like a toy. I can imagine users who are given this tool can come up with great ideas. It might also provide a way to better get client meetings rolling.”

The ability to work with alternative stimuli to enhance ideation sessions was also considered positively by one designer:

“Based on our meetings, I’ve got the feeling that this tool vastly stimulates people’s minds resulting in discussions about use cases and control mechanisms. I consider it suitable for collaborative working, even though you only know for sure once you’ve actually tried it out in a project.”

Using the toolkit in participatory design sessions with potential users was exemplified by another expert. She envisioned creating applications first within

the design team and then verifying those early concepts and ideas in field studies to span the divide between interactive prototypes and evaluation cycles. “I’d improve and extend it first with a specific user scenario in mind, and then give it to people involved in such a scenario...”, was a quote stated by one participant concerning these matters.

Communicational Aspects

The second frequently occurring pattern in the interview sessions dealt with the use of the toolkit for communicational purposes (e.g., sharing ideas with an audience during the design process). One designer stated that he could envision the usefulness of the toolkit but would need to work with it first: “It’s hard to tell (if the toolkit is useful for these purposes) at this stage since we haven’t used it in practice. But I believe it’s got the potential to be a communicative tool.”

The portability of both the device and the implemented toolkit was considered to be an advantage; one participant defined the benefit of being able to “...carry your ideas around...” This aspect was further substantiated by a participant from a different design studio: “I believe it serves well for showing ideas to others because it’s based on a portable device.”

Being able to quickly explain and communicate interaction design concepts to different audiences was discussed by one participant who shared his experience of familiarizing other people with novel technologies: “I consider it useful for people who want to familiarize themselves with the concept of tangible user interfaces and thus would give it to such persons. I would also show it to clients so that they can learn about our design practices and understand how the ideas for their polished products are created.”

Limitations and Extensions

The third area we identified covered a discussion of which aspects of our implementations the participants considered limitations or what extensions they could envision being useful in the future. One participant stated his doubts regarding working with already pre-defined artifacts instead of starting completely from scratch; he expressed his desire to work with arbitrary objects for TUI representations: “Perfectly shaped objects like paper pyramids or cubes can constrain you (in the design process). You might get used to these provided shapes and not feel the need to try out other form factors. Random everyday objects are much more exciting and let you explore.”

The pre-defined graphical representations offered by the application provoked discussion of extensions to the provided samples. An interaction designer considering the state of the application and how he would conceive of further features stated, “I feel like I can already try out a lot. I like the knob that incrementally adjusts a number because it lets you do something that is not

copied from a 2D interface. Further controls should work in a similar fashion, taking advantage of the potential of hybrid interactions. So maybe a gesture recognizer for custom slider actions could be a next step.” Additional extensions were put forth by a participant who expressed his desire to work with greater variation in customizing the displayed interface representations; he expressed a desire to use audio/visual content to allow more freedom in creating mockups: “So far, the number of available visuals is rather limited. However, I’ve noticed that it’s enough for trying out several things. Now I’d like to be able to adjust the visuals to the context. So if this was some kind of car game, I’d like to insert pictures of streets and lights and cars.”

Another participant expressed his familiarity with the commercial two-dimensional interface toolkits he and his co-workers frequently used for early mockups of interfaces. He discussed his experience with these tools and with the artifacts present in the interview sessions. He perceived the novelty of our approach and mentioned the opportunity to compare the toolkit with already established methods. “From GUI design tools like *Balsamiq Mockups*⁴⁷ I’m used to having lots of different structure and control elements, so I would also expect this in a TUI design tool. However, obviously not as many UI controls have been established in this area.”

6.12 Summary and Contribution

Over the course of this section, we presented an approach to designing tangible interactions using low-fidelity physical shapes to explore form factors. We introduced a way of enabling the recognition of these artifacts on capacitive sensing devices. We created an application that allowed users with no prior coding experience to create early instantiations of physical control elements using screen interactivity. Our approach is replicable as the necessary toolkits have been made available via online platforms including (a) building physical artifacts, (b) clear instructions on the techniques and hardware presented, and (c) the source code to necessary to install the created applications on capacitive sensing devices. We exemplified the practical use of our implementations through case studies with industrial partners and explored the usefulness of our approach through repeated expert interviews and usability tests with potential users.

We further observed that our approach potentially allows an integrative co-design of physical and virtual interfaces while being technologically robust and reliable. Quick explorations of physical form factors and mappings of conductive

47 <http://www.balsamiq.com/products/mockups>

ink lines for digital functionality enabled the design team to quickly try and test early exploratory concepts for their system on the fly. According to Buxton (Buxton, 2007) a sketch of an early design concept should exhibit design properties such as minimal detail, quickness, disposability, and inexpensiveness etc. Hence, we believe that a consolidation of low fidelity cardboard elements on the physical side and visually non-designed interactive interface representations on the digital side match well in an early phase of the design process and can help in appropriately developing a TUI.

Classification

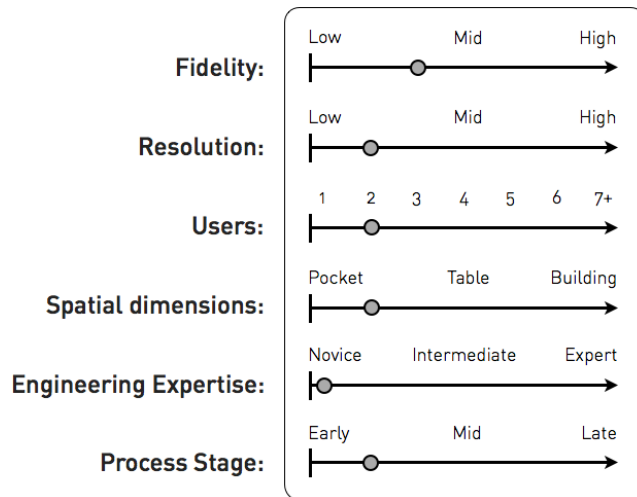

Figure 49. The “business card” of *Sketch-a-TUI* as quick visual reference.

Considering the visual overview depicted in Figure 49 we categorize this implementation according to the following characteristics:

- Similar to the previously discussed toolkit *Paperbox* the artifacts of *Sketch-a-TUI* represent also a mixed-fidelity approach using low-fidelity physical artifacts and partly functional mid-fidelity digital artifacts.
- The same applies for the resolution of the toolkit of the physical/digital embodiments are kept at a lower level due to the nature of their clear geometric shapes and the digital artifacts that do not incorporate and design elements.
- A maximum of two simultaneous users is feasible on the device we conducted our testings (here iPad, version 1).
- One additional benefit of the toolkit is the small form factor that allows a quick transportation to various places and also makes it practical to conduct user testings.
- Even novice users without any previous coding experience can work with the toolkit installing the provided shapes and the *Sketch-a-TUI* application. The engineering expertise required to work with the toolkit is therefore kept at lowest levels.

- As the expert evaluation in section 6.5.1 exemplified, the toolkit is meant to be used in early stages of the design process, for example when a design team is envisioning interaction concepts and form factors for a TUI on a capacitive screen.

IV.

Prototyping In-Tangible Interactions

Design is a funny word. Some people think design means how it looks. But of course, if you dig deeper, it's really how it works.

Steve Jobs

7. Prototyping Touch-less Interactions

In the following we⁴⁸ share our experiences designing a touch-less interface in an industrial context. The first part of this section is devoted to challenges and the opportunity space that these interaction forms provide. Next, we share our lessons learned while prototyping a touch-less interface with an industrial partner in a medical context. In the mid part of this section, we reflect on our experiences using (open) off-the-shelf hard- and software components to prototype early interactive instantiations of the interface concepts. We further show how the experience (-based) prototypes that were created with these platforms, have transformed into a high-fidelity prototype and finally turned into a marketable product. In the final part of the section, we share our summarized contributions.

⁴⁸ The scientific plural in this section refers to all persons involved in this research phase – namely Alexander Wiethoff and Florian Müller

7.1 Advantages and Challenges of Touch-less Interaction

7.1.1. Advantages

Touch-less or contact-less direct manipulation interfaces have drawn increased attention in the recent years in both research and industrial contexts. This science technology is about to mature and find its distribution in various use cases (e.g., Microsoft Kinect). This is in large part due to reduced technology costs and other beneficial advantages in particular contexts compared to direct touch-based interaction forms using graphical screens. Saffer (Saffer, 2008) and de la Barré et al. (de la Barré et al., 2009) pointed out contexts of use in which these interfaces can prove beneficial compared to their touch-operated counterparts:

- Sterile environments or rooms with high hygienic standards. In these environments, interactive touch-based surfaces have to be permanently disinfected to prevent disease from spreading. Usually, these devices are covered with a thin layer of transparent foil (see Figure 51, right), which has to be changed after each use. In these contexts, touch-less interfaces can provide the benefit of saving time and costs, since they do not require the same intensive cleaning procedures.
- Vandalism-prone environments. Due to the utilized sensing technologies such as cameras or capacitive sensing arrays, the tracking of the users extremities can be executed at-a-distance and thus allow these interface types to be protected, for example, via bullet-proof glass to prevent vandalism in public spaces.
- Co-located use of shareable displays. Using large interaction canvases, direct touch input may prove impractical in some cases due to the screens' size. Touch-less input mechanisms have the advantage of being easily scaleable and thus, enhance the experience of working with distributed interface environments in collaborative scenarios (e.g., classrooms).
- Moving objects in a 3D space. An interaction that requires users to work in a third dimension (e.g., construction tasks) *feels* more natural if the interface can operate also in a z-axis rather than translating input from two axis in a third dimension.
- Contact-free interfaces allow to operate tasks with limited cognitive load within very short time spans. These interfaces can not even require a GUI to give visual feedback (e.g., smart light switches).

- Spatially separated displays that are intended to be used in a certain viewing distance (e.g., watching TV).

De la Barre et al. (de la Barré et al., 2009) further summarized that even though these systems might not perform as accurate as GUI-based touch input systems and thus result in a slower task completion time, these interfaces enable users to experience more playful interactions.

7.1.2. Challenges

Although the previously discussed advantages can be beneficial in certain contexts, prototyping these systems bears challenges. Unlike GUI-based touch input systems, touch-less interaction forms currently include construction related limitations that demand a deeper consideration when designing these systems. As Saffer (Saffer, 2008) exemplified:

- Screen coverage. When interacting closely with a graphical screen through touch-less interaction, parts of the visible area of the screen will be covered through the users' hand and thus not be visible.
- If *pointing* is implemented as an interaction concept the users' movements while remaining in a particular position have to be filtered and must not influence the intended interaction (e.g., by accidentally triggering unintended actions).
- Accidentally triggered actions through randomly performed gestures within the interaction zone demand additional design considerations to assure that only intended interactions will be executed.
- As has been pointed out in section 2.1.1, in order for the interface to gain widespread acceptance, an appropriate *mapping* of the performed gesture set to the resulting digital behavior of the interface must be found that is just as easily comprehensible to users as the interface of other systems that operate in a variety of public contexts.

7.2 Industrial Case Study

We were approached by an industrial company confronted with the challenge of designing interactions on a touch-less device (see Figure 50). They were in the process of developing a functional, high-fidelity hardware prototype and were now considering a variety of potential use cases for the device in question. One potential scenario they had in mind was the medical domain, due to the previously discussed hygienic advantages of such a system.

However, the company was left with the task of prototyping a variety of feasible, cost-effective interaction concepts for the given domain in time.



Figure 50. A high-fidelity prototype of a new device with the capability to recognize free hand gestures performed in front of the screen.⁴⁹

An additional challenge was that the high-fidelity prototype (see Figure 50) required specialized coding experience and a high amount of (electrical) engineering expertise, which would not allow the exploration of a variety of design concepts without big hassles.

7.3 User Research

7.3.1. Setup and Participants

To gain a better understanding of the design and opportunity space in the medical domain, we undertook a phase of user research in the field. We conducted this process phase in conjunction with three large hospitals in three different cities.

The data was gathered through structured interviews with eight medical doctors working in emergency rooms who were either on stationary duty or who had the responsibility of operating complex medical equipment.

The individual interviews were structured as follows: First, the participants received an introduction to the design context and the aim of our research goals. For this purpose, we presented imagery of reference literature to illustrate touch-less interaction concepts. Next, we directed our answer/response scheme on their daily *tasks* and *routines* and the *technical equipment* they were using to accomplish them (see Figure 51). In the mid part of the interviews, we focused on *issues* and *circumstances* they repeatedly experienced. Finally, we asked how they would envision possible solutions for some of the mentioned problems.

To additionally substantiate the gathered data, we noted our own observations in this domain using the *shadowing technique* (Moggridge, 2006) by spending time in emergency rooms and operating theaters (see Figure 51).

7.3.1. Data and Analysis

We used a priori coding (Corbin and Strauss, 2008) based on the the previously discussed interview themes to analyze the data sets. In a second step, we created affinity diagrams (Beyer and Holtzblatt, 1999) to consider recurring response patterns stated by the participants. The most prominent findings were categorized according to the matching domains.



Figure 51. Images from the user research phase in three public hospitals: An operation theatre in a large hospital (left) and our focus on the technical equipment the surgery teams were working with (right).⁵⁰

7.3.2. Findings

We summarized the outcome of the interview transcript in a bullet list of design opportunities, which also served to inform our industrial partner:

- The replacement of current touch-screen and keyboard/mouse operated equipment in sterile environments such as the emergency room or the operating theatre. Design opportunities arise especially for recurring task patterns such as viewing medical imagery (e.g., x-ray images, ultrasound snapshots, magnetic resonance imaging, 3D charts, etc.).
- Technical support during patient visits. A touch-less display can replace the analog transportation and filing of patient records. The system, if embedded in a trolley, remains aseptic while taking it from room to room, thereby saving time accessing data and images.
- An integrated control system for the operating theatre. A system equipped with a contact-less interface allows a sterile usage of any person present to set and change global parameters for this environment such as the lighting system, air conditioning, laboratory and diagnostic systems, music, x-rays, etc.
- The replacement/extension of the stationary workstations through touch-less interfaces for certain standard tasks. Doing so can potentially increase the sterility outside the operating area as well.

- Establishing a centralized online access point to patient data. This implementation should result in the design of a clearly arranged navigation infrastructure while reducing the amount of software currently required for patient management.

Out of the identified design opportunities we picked two findings that were taken into further consideration. The selection was undertaken via a retrospective discussion of the gathered insights by the design team.

7.4 Scenarios, Interface Concepts & Expert Review

7.4.1. Scenarios

Based on the previously discussed user research findings, we looked into two usage scenarios, considering daily routines and activities:

- (1) The use of the device in question for stationary visits to assist doctors on their ward round. The touch-less interaction mechanism would support the browsing of patient records and allow doctors to carry the device from room to room in a trolley without extensive disinfection.
- (2) We learned that surgeons routinely required the help of nurses to change their gloves after coming in contact with the viewing device in order to browse and change the parameters of x-ray images.

7.4.1. Interface Concepts

To enhance the usability of the system, we envisioned that the z-axis of the interface would be detached in three different dimensional regions (see Figure 52): The initial *approach area* would give the user feedback that the system had tracked and recognized him/her without influencing the intended interaction. In the second layer, the *indexing area*, we envisioned the user in a *hovering state* and the interface offering a variety of possible actions. In the third level, the *working area*, users had the option of operating and changing parameters that would affect the intended action.

7.4.2. Expert Review

To further substantiate and verify these concepts, we conducted a formal expert review and presented our scenarios and interactions concepts to a team of hospital IT technicians. We chose this user group as they were constantly testing and reviewing the hardware used in their hospital.

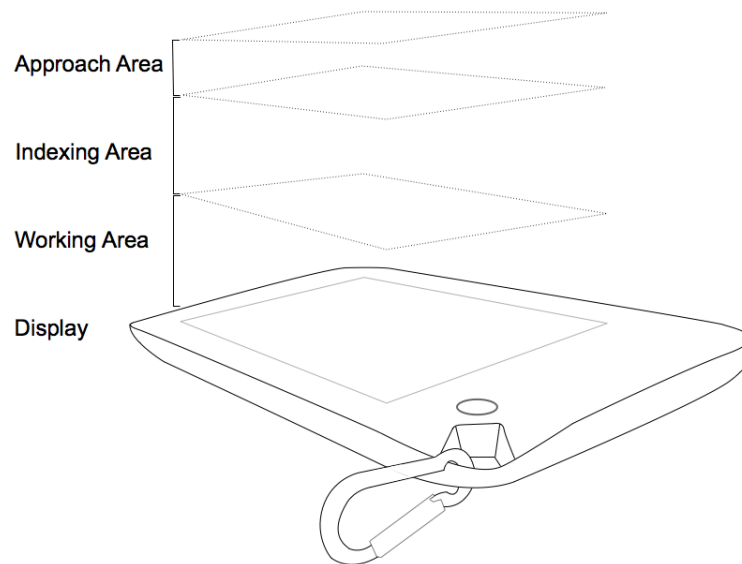

Figure 52. The interaction concept for a touch-less interface with the detachment into different three dimensional regions to guide the user.

The expert review was conducted at the technicians' office and lasted two hours in total. We had three participants (three male, average age was 35 years) who were introduced to the design context at the beginning for 15 minutes. We subsequently presented our research findings and the chosen scenarios in conjunction with the envisioned interaction concept (see Figure 52 & 53). From this session, we learned that all participants considered our second usage scenario, previously discussed, the most promising.

They stated that the reviewing of x-ray images in the shock room of their clinic was a reoccurring task and demanded three frequent activities:

- (1) Selection of the patients' imagery.
- (2) Panning and zooming of x-ray images.
- (3) Selection of different grey scales to review different aspects.

All participants agreed that a contact-less interface solution would provide the clear benefit of being more hygienic and less care intensive than the touch-screen based counterpart.

After choosing the usage scenario based on the outcome of the expert review, we further extend the interaction concept: In addition to breaking down the z-axis in different interaction zones vertically, as depicted in Figure 52, we incorporated the concept of dissecting the interaction space horizontally (x+y axis) in different *regions* as described by Ryu (Ryu et al., 2010) or Echtler (Echtler, 2009). According to the underlying conceptual model in these works, screen spaces can be separated into different *regions* with *individual* interactive behaviors. We considered this framework as a promising extension of our usage scenario, as it supports multitasking. For example, an x-ray image can be viewed in one region by supporting *zooming* and *panning* while a list of grey scales can be scrolled up and down in a different region.

As was pointed out in section 2.1.1, the main challenge with designing intangible interactions lies in finding the appropriate *mapping* between physical action and digital representation while making this relationship comprehensible to the user. Since the haptic touch sensation is missing in this context, researchers explored various forms of providing appropriate feedback (Hilliges et al., 2009). We also investigated several means to provide feedback in the different interaction zones the user entered and explored different interaction opportunities. We envisioned four different visual feedback concepts for finding the *most appropriate* digital representation to suit the context:

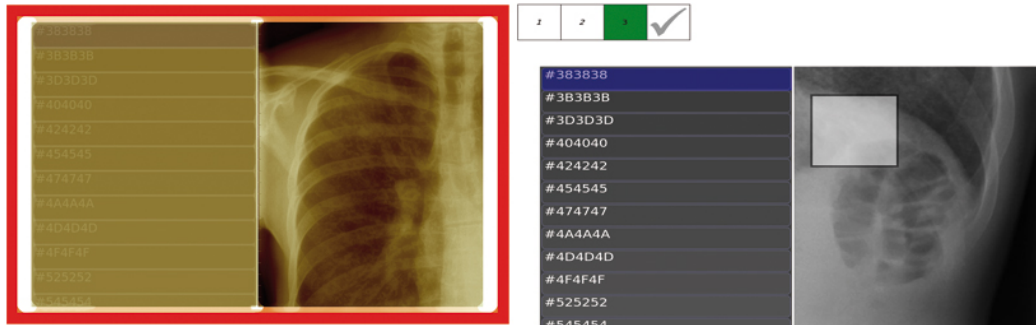

Figure 53. Two forms of providing visual feedback for the different interaction zones: The color frame concept (left) and the level indicator (right).⁵¹

- **Color Frame:** The different interaction zones and regions (see Figure 52) are associated with differently colored frames around the screen. The *welcome area*, for example, triggers a red frame, the *indexing area* a yellow frame while the *working area* is boarded in green (see Figure 53, left).
- **Dialogue:** The interface presents short speech-bubbles that indicate (a) which area the viewer is in (see Figure 52) and (b) the possible actions to be taken.
- **Level Indicator:** A permanent displayed graphical representation of the different interaction areas indicate the current status to the user (see Figure 53, right).
- **Altimeter:** In a combined approach of UI concept 1 & 3, we aimed at providing the user a permanent indication of their spatial distance to the display and through differently colored numbers the matching interaction zone (see Figure 52).

However, we were now confronted with the challenge of creating early interactive instantiations of these interface concepts in order to verify our assumptions through user testings and filter out the least promising. Since time and cost were additional constraints given by the industrial partner, we searched for alternative means to create interactive mockups.

⁵¹ Photos © Alexander Wiethoff

7.5 Using Open Soft- and Hardware Components

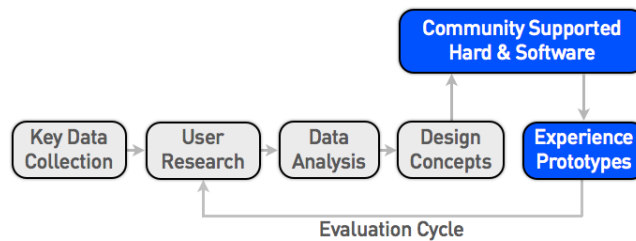

Figure 54. A design process extension in the experience prototyping phase through the utilization of community-supported (open) hard- and software components.

Certain open hardware platforms have the core benefit of being easily accessible, widespread and community-supported. Hence, we investigated this domain to find tools that would provide us with the most suitable starting points to experiment with interactivity in the given design context (see Figure 54).

As a frequently used hardware platform to detect movement and gestures we relied on Microsoft's Kinect⁵² in conjunction with a standard PC running a Ubuntu Linux distribution⁵³ and the libfreenect⁵⁴ framework installed. For our middleware client we chose Nite⁵⁵ by Primesense since it offers an application programming interface (API) for movement detection that is well documented and easy to use with various standard programming languages such as for example C++ or Java. We used the QtQuick⁵⁶ software application framework to create the different UI elements. The framework relies on the scripting language QML which, like other UI toolkits such as JavaFX⁵⁷, supports the rapid exploration of different visual user interface elements through the combination of pre-defined code fragments.

We created a simple software application using the previously mentioned programming environments which relied on mouse movement (x+y-axis) and mouse events (z-axis), that are schematically depicted in Figure 55.

52 <http://www.microsoft.com/en-us/kinectforwindows/>

53 <http://www.ubuntu.com/>

54 <https://github.com/OpenKinect/libfreenect>

55 <http://www.primesense.com/Nite/>

56 <http://qt.nokia.com/qtquick/>

57 <http://www.oracle.com/technetwork/java/javafx/overview/index.html>



Through the mouse driver Uinput available in Ubuntu we used the position of the users' extremities in the z-axis to trigger mouse events such as key presses and key-releases that served for the selection and deselection of different interface elements.

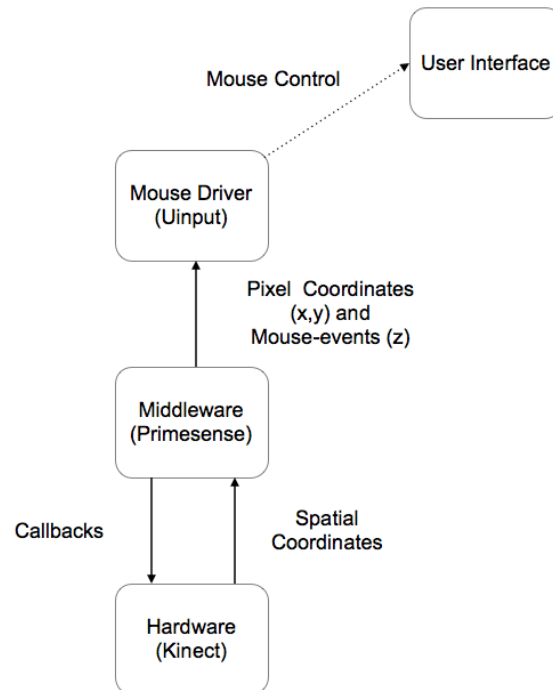

Figure 55. Overview of the soft- and hardware components used for prototyping intangible interaction.

With this approach, we suggest a possible design process extension in the experience prototyping phase (see Figure 54) in which a design team aims at exploring their design concepts in interactivity and receive early feedback on which design direction might lead to a usable and enjoyable outcome.

This setup is limiting in the sense that it does exclude more complex gesture sets. However, using the described soft- and hardware tools, within a short time (i.e., one afternoon), we were ready to primarily evaluate our interaction concepts in conjunction with potential users.

7.6 Experience Prototyping & Evaluation

To verify our assumptions about designing a touch-less interaction concept on a mobile device, we used the previously described prototyping setup (see Figure 55). Furthermore, we wanted to know if the concepts, prototyped with this infrastructure, could be transferred to a high-fidelity prototype (see Figure 50) without any changes in the interaction concept. To investigate this matter, we conducted an extended user study that was split into different phases:

- (1) In the first explorative study phase, we used the prototyping tools that were described in section 7.3 to initially test our design concepts in interactivity and thus filter out the least promising.
- (2) In the subsequent, formal study phase, we transferred the most successful design concept to the high-fidelity prototype depicted in Figure 50.

The first study setup aimed at finding the *right* design concept for the context. In the second study setup, we were interested in finding out whether users could easily learn and memorize the implemented interaction concept. For this purpose, we chose a study design that aimed at investigating the *immediate usability* of the system (Wobbrock et al., 2005).

7.7 Exploratory Pre-Study

7.7.1. Setup and Participants

The experiment was conducted at a technical workshop in the facilities of the industrial partner, a mid-size hardware manufacturer (+100 employees) of embedded touch-screen solutions. In this setting we had a total of five participants (one female, average age was 32 years). Two of the participants had a background in business administration, while three had a background in electrical engineering. In a self-assessment of their technical knowledge, the participants rated themselves with a mode value of 4 on a five-point Likert scale ranging from 1 meaning “no technical knowledge” to 5 meaning “expert technical knowledge”.

The experiment was conducted as follows: Every participant received a 5-minute introduction to (a) the design context and (b) the prototyping setup. Afterwards, the participants received a *walk-thorough* on how the in-tangible interaction mechanism was working (see Figure 52). Next, we gave the participants a brief introduction to the different visual feedback concepts and explained their meaning (see Figure 53).

In a subsequent step, all participants had to carry out a usage typical task four times using different forms of visual feedback (see Figure 53):

- Search a specific region in an x-ray image by using the *zoom* and *pan* tool.
- Use the *virtual lens* tool (by changing the interaction zone) and position it over the the x-ray image.
- Change the grey value of an image to the value “#EBEBEB” using the list on the right side of the screen.
- Switch between grey scale adjustments to the *virtual lens* tool and search for one specific aspect.

The different visual feedback patterns were presented to the participants via a 4 x 4 latin square to avoid bias. All participants were recorded on video for additional analysis.

7.7.2. Data and Analysis

In this exploratory study setup, we primarily investigated the “ease of use”. After completing the task the participants had to carry out, we provided them with a follow-up questionnaire that included a Likert scale and open questions. The resulting data sets were clustered and the different interactions compared with each other.

7.7.3. Preliminary Findings

The two interface concepts depicted in Figure 53, namely the *color frame* and the *level indicator* design, received the highest ratings considering the “ease of use”, (mode=5). The *altimeter* representation that was described in section 7.2.2 was ranked third (mode=4) and the *dialogue* interface concept ranked last (mode=3). These findings were supported by the additional question on the “favorable design concept”. All participants chose the *level indicator* interface concept that is presented in Figure 53 (right) as the most favorable for the given context. The

color frame concept was ranked second, the *altimeter* third and, again, the *dialogue* interface ranked last.

After analyzing the open questions, we learned that the participants could operate the interface and accomplish the given tasks successful without further assistance and that they considered the immediate feedback provided by the *colored frame* and the *level indicator* as being “easily comprehensible”. Also in this case, the *dialogue* and the *altimeter* design were described negatively by the majority of the participants (four of five), as they considered these design solutions “too distracting”.

As a result, we opted for a combination of the interface concepts depicted in Figure 53 for the final implementation on the high fidelity experience prototype (see Figure 50). This was done for two reasons:

- (1) The participant appreciated the peripheral guidance of the color frame that allowed them to “stay focused” on the given task.
- (2) The participants appreciated the permanent feedback on the current level in the interaction zones and that they could see at-a-glance which level was *above* and *below* the area they were currently interacting with.

7.8 Immediate Usability Evaluation

In the second study setup, we transferred our findings from the previously described interface concept to the high-fidelity experience prototype. However, this time we included several technical differences compared to the in Figure 54 depicted prototyping setup:

- (1) The tracking of the users extremities happened through a purpose-built capacitive sensing layer positioned atop the TFT display (see Figure 56).
- (2) The sensing technology allowed a more precise tracking that resulted in closer distance to the display than the distance enabled by the previous setting (see Figure 54) in which the users had to be approximately one meter away from the hardware in order to be safely detectable. Hence, the embodied interactions had to be performed at a larger scale to affect the interface. This consideration calls into question whether a system tested on alternative prototyping equipment **can be easily transferred** to a device with different sensing technology as well as different form factors and thus result in different implications.

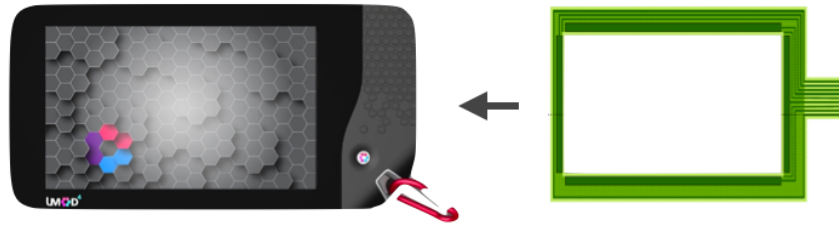

Figure 56. The capacitive sensing layer of the high fidelity prototype, responsible for the detection of the users' extremities above the TFT screen.⁵⁸

7.8.1. Setup and Participants

After considering the study design, we opted for a setting that investigated our implementations of the perspective in a typical usage scenario. We wanted to know if our intangible interaction concept, prototyped with a different technology, as previously discussed, could be easily learned and memorized.

To do this, we referred to the inspection methods proposed by Ryu (Ryu et al., 2010) or (Wobbrock et al., 2005). In their studies, the *immediate usability* of a novel and unfamiliar interaction system was inspected by giving subjects a usage-typical task. After a 5 minute break, the participants had to repeat a similar task, this time without being given any prior instructions.

By comparing the completion time and error rate, the *immediate usability* was derived by the significant improvements and additional conclusions from a follow-up questionnaire.

In the second study we included a total of twelve participants (three female, average age was 33.5 years). To inspect the *immediate usability* of our system we used a task design closely related to a usage scenario as observed in our previously presented user research phase (see Section 7.2.1).

The individual experimentations were conducted as follows: First, the participants received a 5-minute introduction on (a) the systems technology architecture, (b) application features and (c) given tasks. Next, the participants had to carry out four similar (sub) tasks equivalent to the ones described earlier in section 7.2.1 (e.g., browsing and color adjustments of an x-ray image). The participants had to perform each of the given tasks four times using a 4 x 4 latin square. After each run, the participants took a break.

7.8.2. Data and Analysis

After completing the given sub-tasks, we took quantitative measurements of four different values:

- (1) Task completion time.
- (2) Area changes (e.g., when a user moved to a different interaction zone as depicted in Figure 52).
- (3) Target-based interactions (e.g., each interaction performed in a specific zone to accomplish the given task).
- (4) Error rate (we considered cases as an “error” when users interacted within wrong areas).

After each run, we handed out a qualitative follow-up questionnaire that contained Likert scale and open questions. The questions targeted two different parts of our system.

- (1) We focused our Q&A scheme on *target-based interactions* in the first part, such as system feedback and specific interface features.
- (2) We addressed the *ease of use* of our system in the second part to further substantiate our measurements regarding the *immediate usability*.

7.8.3. Quantitative Results

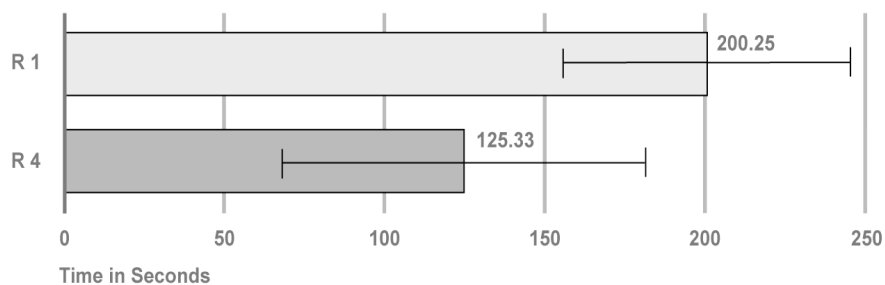

Figure 57. Mean values of the task completion time between round one (R1) and the final run (R4).

Looking at the quantitative data-sets we found that the participants increased the completion speed by 62.59 % from a mean value of 200.25 seconds (SD=40.45sec) in the first (R1) to a mean value of 125.33 seconds (SD=59.12sec) in the fourth (R4) run (see Figure 57). A paired t-test suggests that there is significant difference in the task completion time between the first and last round with the gestural interface implemented on the high-fidelity prototype ($t(11) = 3.847, p < 0.003$).

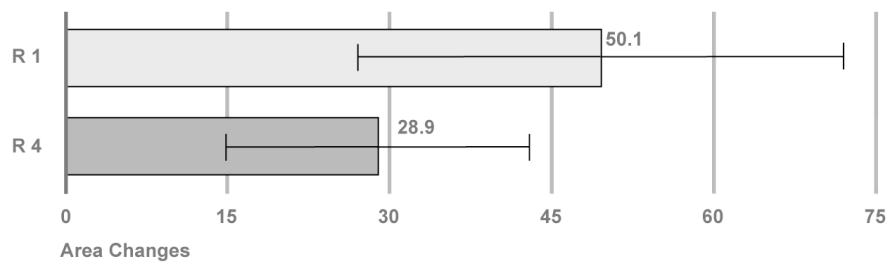

Figure 58. Mean values of the area changes users needed to accomplish the given (sub-) tasks with R1 and R4 in comparison.

Considering the *area changes* (see Figure 58) needed to accomplish the given task we observed that the participants improved from R1 (M=50.1sec., SD=25.54sec) to R4 (M=28.9sec., SD=14.68sec.) significantly by 42.51 % ($t(11) = 2.304, p < 0.044$).

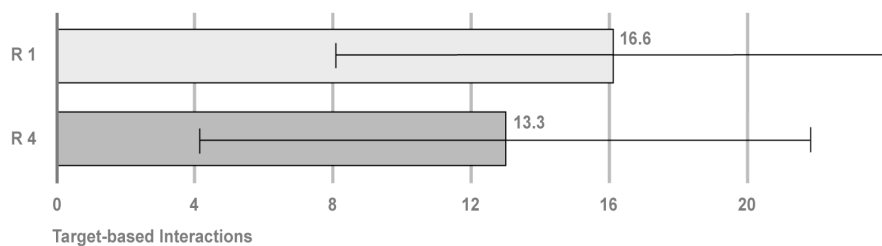

Figure 59. Target-based interactions (interactions performed in a specific area) users needed to accomplish the given (sub-) tasks.

The *target-based* interactions (see Figure 59) needed to accomplish the given sub-tasks decreased slightly by 12.12 % from round R1 (M=16.58, SD=8.08) to

R4 (M=13.25, SD=9.67). However, in this case, the improvement indicated no significant difference between the two data sets ($t = (11) 1.159, p < 0.271$).

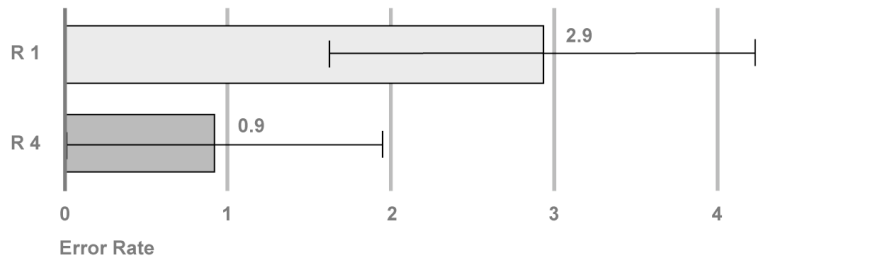

Figure 60. The errors (false area interactions) made accomplishing the (sub-) tasks from R1 to R4.

The *error rate* was reduced by 68.96 % from round 1 (R1) (M=2.92, SD=1.31) to 4 (R4) (M=0.92, SD=1.08) while the applied t-test suggested a very significant improvement ($t = (11) 6.663, p < 0.0005$).

7.8.4. Qualitative Results

In the first part of the follow-up questionnaire, the *target-based* interactions were inspected. We asked if specific aspects of the prototype such as the *menu navigation* or other related items were easily comprehensible and learnable in a short time. The summarized results of both parts are depicted in Figure 61 and 62. Figure 61 indicates that the gestural interaction concept, the *zooming & panning* tool and the *menu navigation* were well received by the participants with a high positive response frequency. However, the expected system response (see Figure 61) did not receive an equivalent positive response frequency due to calibration difficulties with the sensors depicted in Figure 56. Unexpected system behavior (e.g. loss of the tracking) affected in few cases the *flow* of the overall interaction experience.

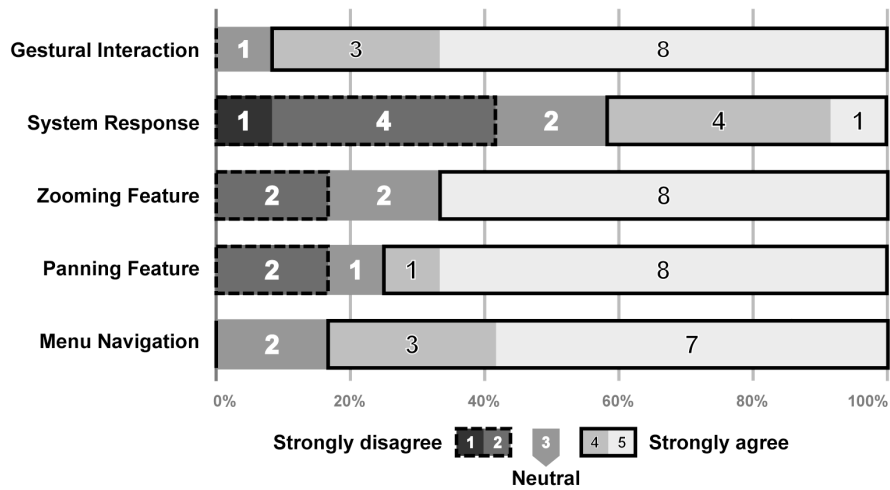

Figure 61. Investigations on target-based interactions: response frequencies to the prompt “This aspect of the prototype was easily comprehensible and quickly learnable”.

In the second part of the follow-up questionnaire we investigated the overall interaction concept and the general usability to span connotations between the task completion time, error rate and the perceived “ease of use” after accomplishing all tasks (see Figure 62).

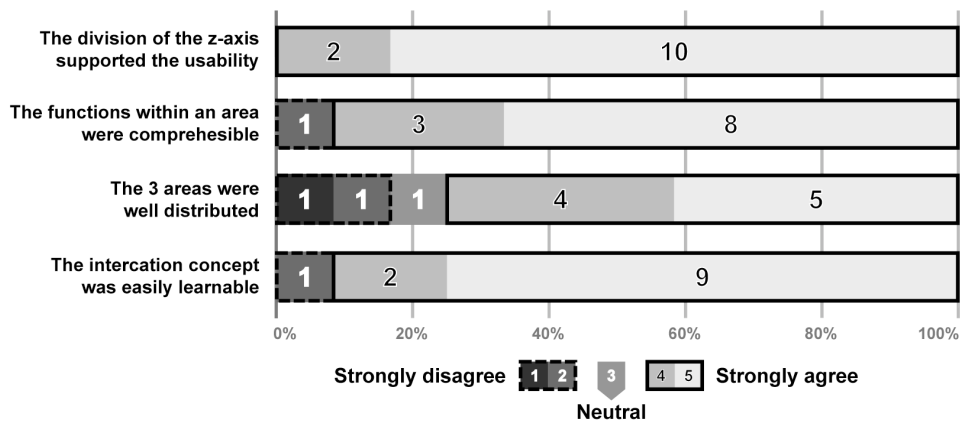

Figure 62. Investigations on target-based interactions: response frequencies to the prompt “This aspect of the prototype was easily comprehensible and quickly learnable”.

We learned that all participants rated the division of the x-axis into different interaction zones positively (see Figure 62). Furthermore, the response frequencies were primarily positive when asked if the participants could easily *follow* the functions within an area. Regarding the spatial distribution of the areas, out of the twelve participants, nine responded positively, while three gave a negative rating, suggesting (possibilities for) improvement in this realm. The *learnability* of the interaction concept had a similar positive distribution of response frequencies to the initial question on the supportive usability of the interaction concept (see Figure 62).

7.9 Discussion

Looking at the gathered data of both study setups, we conclude that the intangible interface created with the aid of community-supported hard and software components received a positive outcome: Users were able to perform the given tasks significantly faster and with fewer errors from R1 to R4. These measurements are supported by the high amount of positive response frequencies gained through the questionnaires, which indicate that the implemented system was easily comprehensible and the touch-less interaction mechanism could be learned and repeated shortly thereafter.

We consider these findings as promising for a successful implementation of the created interface components to contexts such as the one described by current circumstances. Hence, the usage of community supported (open) hard- and software components allowed the design team to experiment with interactivity in a timely and cost-efficient manner while being still in early/mid phases of the design process.

7.10 Summary and Contribution

In summary, we presented an extended design process for an intangible interface. By using off-the-shelf hard and software components to prototype the system, we explored these off-the-shelf tools as an alternative *sketching* medium to explore a variety of design ideas in interactivity before increasing the fidelity. Others can replicate this approach by referring to our utilized components. A two-step study presented the possibility of evaluating such an approach in industrial contexts. In summary, we recommend investigations into (open) soft- and hardware components as a suitable solution when prototyping (intangible) hybrid interactions.

Classification

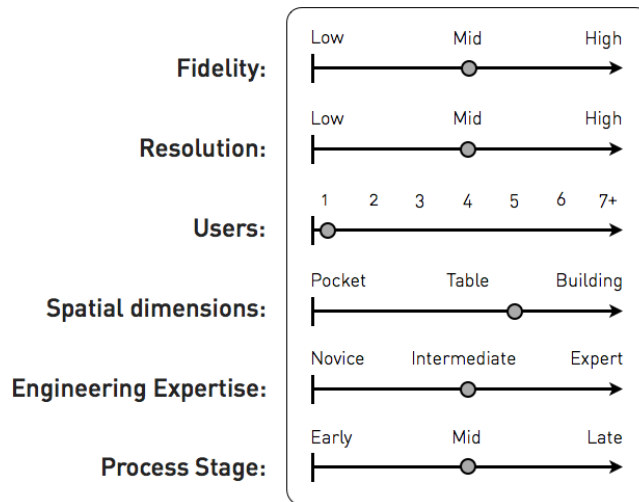

Figure 63. The visual classification of the chosen prototyping approach, using off-the-shelf hard- and software components that are supported through the community.

Referring to the classification in our visual overview, as depicted in Figure 63, we categorize this approach according the following characteristics:

- Using open off-the-shelf hard- and software components to prototype intangible interactions results in mid-fidelity prototypes that represent early instantiations of ideas, however, these artifacts might not be very far from resembling the final outcome.
- The resolution of such an approach is ranging at medium levels as a large amount of details can be included, however, features that a prototype on a higher fidelity incorporates might not be realizable at this point.
- In our case, the prototyping setting supported one user interacting. However, this can easily be scaled by using additional hardware components.
- The spatial dimensions for the prototyping setup in the presented case used a space of approximately 2 x 2 meters, since the hardware components (here Microsoft Kinect 1.0) required a certain distance for a safe detection of the users' movements. The constant improvement of hardware, for example the latest model of the Microsoft Kinect (2.0), allows even more precise control and as a result requires smaller experimental settings.

- The realization of prototypes with this approach currently does require coding experience and (limited) technical knowledge. Shortcomings in technical abilities can be addressed with the support of forums, wikis, chats etc.
- We categorize this approach at mid-process stages, when a team of designers is in the process of exploring concepts on an interface level and investigating interactivity. The timely and cost-efficient nature of this approach keeps the investment on both factors low and still allows radical changes in the direction of the project, if required.

8. Prototyping Remote Interactions

In this section we⁵⁹ share our experiences prototyping a remote interaction system connected to a media façade in a public setting. In the first part, we provide an introduction to the topic, along with domain-specific challenges. Next, we present our design process extensions in the form of a purpose toolkit that was meant to (a) test hardware and (b) content explorations before the actual implementation. We subsequently transferred the results to a higher fidelity, in this case a prototype implemented in conjunction with a large media façade, exemplified in the mid section. The remainder of this section is devoted to tailoring an appropriate evaluation method that suits the domain-specific context and initial experiments, in which we used an extended design process to create remote interaction systems. Finally, we discuss our findings and the chosen prototyping approach.

8.1 Context

Urban spaces serve as prime locations for systems embedded in a city's architectural landscape, as demonstrated by Seitinger et al. (Seitinger et al., 2009). In their research project, single light-emitting elements situated on the outer shell of buildings extended the existing structure with a layer of interactivity.

As part of an interdisciplinary research project with the ARS Electronica Center (AEC) and the German Research Center for Artificial Intelligence (DFKI), we were given the task of designing a remote interaction system that is connected to a buildings outer shell, commonly referred to as *media façade*. Designing these systems is a challenging task, since the availability of reference literature on how to systematically develop them is limited. In the last years, researchers and technology enthusiasts started to explore the opportunity space in this domain by providing various input and output modalities for interactions (Mignonneau and Sommerer, 2008).

59 Parts of the work presented in this section has been published in several scientific papers (Wiethoff and Gehring 2012), (Wiethoff and Blöckner, 2011), (Wiethoff and Gehring, 2011) and (Boring et al., 2011). The scientific plural refers to all corresponding authors – namely Alexander Wiethoff, Sebastian Boring, Magdalena Blöckner, Johannes Schöning, Sven Gehring and Andreas Butz.



Figure 64. Light emitting media façades embedded into contemporary architecture that may display (remote) interactive content (from left): Dexia Tower, Brussels, Belgium, Kunsthaus, Graz, Austria and the ARS Electronica Center in Linz, Austria (Wiethoff and Gehring, 2012).⁶⁰

Dalsgaard and Halskov completed a series of case studies on designing interactive media façades in public contexts (Dalsgaard and Halskov, 2010). Von Borries et al. (Von Borries et al., 2007) presented remote interactions with architectural structures that involved large public audiences in playful experiences: They equipped buildings to allow users to play arcade game classics on the façades, such as the game *Pong* using the cellphones of participants as remote interaction mechanism.

Such interventions are commonly categorized under the umbrella term *media façades*, which includes transforming a buildings' architecture with giant public screens. Haeusler (Haeusler, 2009) presented a summary of different media façade types and categorized them according to their technical configuration:

- Frontal projection façades project media content directly onto the building's façade via one or more video projectors.
- Back projection façades project media content from behind the building's façade and onto translucent areas integrated into the building.
- Display façades deliver content through the integration of commercially obtainable “Very Large Screen Video Displays” into the surface of a building.
- Window animations make use of the existing windows in a building by illuminating them so that they are perceived as pixels.
- Illuminant or light-emitting façades integrate light emitting elements into their surfaces (see Figure 64).

⁶⁰ Photos (from left) © : Eddi Janssens, Nicolas Lackner, Nicolas Ferrando and Lois Lammerhuber. Reproduced under a CC BY-NC-ND 2.0 License <http://creativecommons.org/licenses/by-nc-nd/2.0/deed.en>

- Mechanical façades use mechanically movable elements to change façade appearances (Haeusler, 2009).

The first three façade types usually feature high resolutions, while the latter ones may have lower resolution, as these depend on the building's particular architecture (e.g., one window equals one pixel).

8.2 Challenges

This emerging research domain presents novel challenges to a design team prototyping early instantiations for these type of interfaces: Due to their spatial dimension and screen size a remote interaction system offers the advantage of addressing the whole interaction space.

However, as discussed earlier in Section 2.3, prototyping remote interactions presents challenges that differ strongly from regular GUI based interfaces. In our case the features of media façades, as well as the spaces they were located in, presented additional design challenges that were critical for the development of successful applications.

Dalsgaard et al. summarized eight important key challenges designers are facing when prototyping interactions in this context (Dalsgaard and Halskov, 2010). In their work, they specifically highlight the importance of media façades as a new type of interface that differs strongly from existing displays in several ways. Hence, the question arises of whether the prototyping methods used for traditional, desktop-based graphical user interfaces (GUI) may be unsuitable for this context or whether they have to at least be altered to fit this new type of interface.

Besides the technical aspects of remote interaction with media façades, the context in which they are deployed and the exposure of their content to a large audience increases the need for a tailored design process. When placed in a highly public context, people tend to behave differently when interacting with a media façade than with a desktop-based graphical user interface, since they are acting in front of a large audience (Goffman, 1966).

In our case study we considered several additional differences when designing remote interfaces between media façades and regular GUIs:

- (1) The physical properties, such as their size, resolution and display technology.
- (2) Testing and exploring both concepts and hardware before the actual deployment.
- (3) Evaluating the system in the wild.

8.2.1. Physical properties

Media façades have to be treated differently than public displays: They come with much larger display dimensions, which leads to varying viewing distances. Additionally, media façades can include non-planar form factors, as the display might stretch over several edges of the building and thus be visible to different audiences simultaneously. This circumstance can also affect users' interaction experience, since users might not see each other, which presents additional considerations that have to be taken into account when designing remote interactions.

The differences between media façades and public displays apply to a variety of factors that might influence the interaction experience as well. The research carried out in the past on public display interaction (Brignull and Rogers, 2003) has been implemented on TV-sized screens (Miyaku et al., 2004). However, when transferred to a media façade interaction, these approaches do not consider unique characteristics that coin the remote interaction experience with a media façade such as the size, visibility and inherently large audience.

Those characteristics of a media façade might influence the interaction experience in several ways:

- (1) They may be out of the user's reach (partially or totally), requiring interaction at a distance (Boring et al., 2010).
- (2) They allow multiple users to interact simultaneously. Others (i.e., not just the experimenter and participant) will observe the interaction. Aside from influencing the emotional experience, these factors may also affect the usability. In settings with situated public displays that allow for direct touch input, users are aware of each other's actions and a social protocol (crucial for the perceived joy of use) (Peltonen et al., 2008), which are however, both missing on media

façades where users do not necessarily see each other. As an example, concurrent interactions on the façade may lead to frustration, decreasing the user's enjoyment, and thus weakening the overall experience (Wiethoff and Gehring, 2012).

8.2.2. Prototyping

As previously mentioned, Dalsgaard et al. identified different key challenges for designing interactions with media façades (Dalsgaard and Halskov, 2010). The first challenge arose with the fact that media façades are a *new type of interface*, which raises the question of how to prototype early instantiations of such an interface before deployment. Their fourth key challenge, *developing content to suit the medium* is interconnected to the façade types already discussed in Section 8, and thus raises the question of how to test and experiment with content. In other domains, designers can choose from different approaches that would support them in early phases of the design process, as shown in section 2.4.

However, in this design context two circumstances limit such an undertaking:

- (1) **Operating Hours:** Their daily operation is limited to the time-frame when lighting conditions make the content visible. This limits the daily time available for pre-testing to only a few hours.
- (2) **Location:** Media façades are situated in urban prime locations with many passerby. Thus, early content experimentations using the façade will make the result already visible to a large audience, which might influence the final outcome.

These circumstances leave designers to use regular standard type GUI displays for pre-testing: Since 2008 the ARS Electronica Center⁶¹ offers designers the opportunity to download and install a custom software to pre-test content. Their simulator offers a 3D rendered view of the actual façade with the possibility to pre-test content on the building before the final implementation. However, prototyping remote interactions with these tools is not feasible for several reasons.

61 <http://www.aec.at/news/>

- (1) Simulating the outcome on a regular TFT screen differs from the experience of being confronted with colored bright lights. If the façade's lighting technology differs from regular displays, simulating them on a desktop computer may lead to varying results. Thus, results of evaluations regarding experiences in a lab environment using the previously described technology, as considered by Hassenzahl (Hassenzahl, 2010), may not be transferable to the setting at the actual site.
- (2) Pre-testing hardware components (e.g., lighting elements, server, digital multiplex system etc.) with the façade may be hard to implement on regular type displays – especially when direct and absolute techniques are used (Boring et al., 2010). This matter is restricting, since the real-time interplay of the utilized hardware components might be crucial for the success of such a system.
- (3) The closed environment of the supplied software allows very limited experimentation with interactivity and thus does not provide any insights as to whether the envisioned concepts can be implemented.

8.2.3. Study Methods

Evaluating remote interactions in conjunction media façades has rarely been documented. Standard evaluation methods such as the ones presented by (Lazar et al., 2009) or (Corbin and Strauss, 2008) are valuable tools to effectively measure quantitative data (task completion time, error rate, etc.) and the perceived *quality* of an interaction (e.g., through semi-structured interviews, Likert scale questions, diary studies, etc.). However, none fully covers the deeper underlying motivations that are summarized by Hassenzahl et al. under the umbrella term “user experience” (UX) (Hassenzahl, 2010), (Hassenzahl et al., 2010), (Hassenzahl and Tractinsky, 2006) as the circumstance of the interaction (person vs. building) and the consequence of being visible to a large audience (public contexts), which might influence the interaction experience as well. Thus, we argue that a consideration of all previously mentioned approaches can lead to a more holistic investigation of the users' motivations when interacting with such systems. At the same time, interacting with such a technology setup can be considered an experience itself, as compared to how well the system performs in terms of the above mentioned metrics (i.e., quantitative data).

In summary, we believe that these challenges and circumstances described above all have an impact on the interaction experience and thus have to be taken into account when evaluating interactions with these systems.

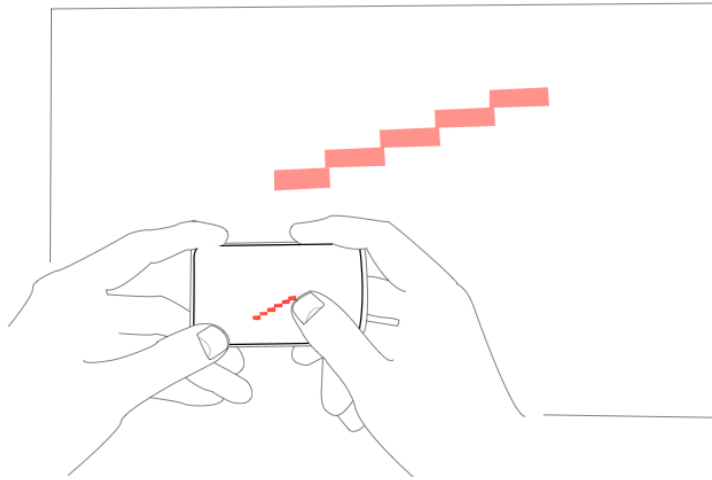

Figure 65. A remote interaction system between a users' mobile device and the façade of a building raises the research question how to systematically prototype and evaluate such a system in the wild.

Compared to studies in the lab, evaluating remote interactions in conjunction with media façades can be considered complex in many ways. In our prototyping setup setting, we were confronted with several challenges that influenced the study.

- (1) **Dynamic Conditions:** we conducted the study during a public art festival with a live, fluctuating audience
- (2) **Limited Time-slots:** The setting in the context of the festival allowed only limited time for each user to interact with the system and participate in a follow up interview session.
- (3) **Multiple Users:** Our setup allowed up to three simultaneous users that could influence the prototype individually or in groups.
- (4) **Goal of the interaction:** Interactions with the system were not task-oriented and rather relied on the experience of the interaction itself.

8.3 Evaluating Remote Interactions

As has already been pointed out, when evaluating remote interactions with media façades, taking metrics into account from the field of UX may provide a more holistic investigation of the users' underlying motivations in these contexts. However, in this domain, various approaches follow different characteristics. One crucial aspect of UX evaluation is to get acquainted with the user, as has been highlighted by Wright and McCarthy (Wright and McCarthy, 2008). In their work, they reviewed relationships in this emerging domain and identified shifting connections between designers, users and artifacts (Wright and McCarthy, 2008). They based their investigations on *empathy* as crucial aspect and suggest that *experience* is central to designer-user relationship to relate appropriate evaluation methodologies. They further point out that the **experience-related** part, crucial for the success of a system, should relate *empathy* in order to understand and apply UX methods appropriately.

In a similar aim Forlizzi and Battarbee addressed the diversity of *experiences* gained through the use of interactive systems (Forlizzi and Battarbee, 2004). They correlate existing approaches to experiences and present a framework for designing experiences that originate with interactive systems. Further, they argue that for novel technologies, an experience-oriented design approach is the only way that interaction design processes can have a valuable impact. Similar to Hassenzahl, we related our research goals and understanding of UX in a final evaluation setup to “positive emotions and affect that people experience while interacting with products” (Hassenzahl, 2010), (Hassenzahl et al., 2010), (Hassenzahl and Tractinsky, 2006).

8.3.1. UX Methods

A meta-survey of Bargas-Avila and Hornbaek (Bargas-Avila and Hornbaek, 2011) exemplified various methods suitable for designing and evaluating UX. The survey demonstrated that UX methods refer to *emotional aspects* when interacting with a system. We also aimed for these aspects in the final evaluation of our system. To investigate such matters, Hassenzahl et al. developed AttrakDiff (Hassenzahl, 2010), a scientifically-applicable tool which measures the pragmatic quality, attractiveness, identity, and stimulation of the interaction with a product or service. However, these values are focused on the product itself and not on the experience generated while interacting with it. The positive and negative affect schedule (PANAS), (Watson et al., 1988) measures and explains

positive and negative effects of a retrospective experience. Creating experience diaries (Korhonen et al., 2010), (Pasupathi et al., 2009) is another commonly used approach. Here, participants write a report about their use of a product over weeks. Geven et al. (Geven et al., 2006) proposed storytelling as a tool for evaluating user experience in narrative interviews (Pasupathi et al., 2009).

In the form of experience reports (Korhonen et al., 2010), storytelling is used to collect data on meaningful experiences with interactive products or services. However, triggering participants to state their experiences in the interview sessions was accomplished by making reference to familiar electronic products. This practice was not applicable to our setup, since our participants interacted with a novel system in limited time-slots.

In summary, the described techniques retrospectively evaluate the experience over longer timespans and do not tackle the in-situ experience during the interaction, which was highly relevant for our context.

To the best of our knowledge, none of the aforementioned methods have been tried and/or explored in the context of media façade interaction using a remote interface. Thus, our goal was to find a method suitable for an in-depth evaluation of meaningful positive experiences (Bargas-Avila and Hornbaek, 2011), (Hassenzahl, 2010) with media façades in a short period of time (i.e., one or two hours). Burmester et al. described the valence method (Burmester et al., 2010), an approach that evaluates the emotional quality of an interaction in two phases:

- (1) In the formative phase, the user marks positive and negative feelings while interacting with a product or service.
- (2) In the summative phase, the interviewer asks participants about reasons for their actions during the interaction, using an in-depth interview method (Reynolds and Gutman, 1988), until they can be matched to the underlying psychological need (Sheldon et al., 2001). This model is also based on Hassenzahl et al.'s UX model (Hassenzahl, 2010). It reduces the complexity of UX with the help of positive psychological needs (such as the feeling of autonomy and competence).

8.3.2. Designing a remote interaction system

To design a system that allows for remote interactions with a media façade (see Figure 64), we followed a user-centered design approach with a purpose built process extension (see Figure 66):

- **Key Data Collection:** In this phase, we looked at reference projects dealing with media façade interaction, interaction design processes, and evaluation methods suitable for this context (see previous section).
- **User Research:** Next, we investigated insights on how potential users may perceive (1) the general concept of interacting with a media façade, and (2) which of our initial concepts for content might be favored.
- **Data Analysis:** Based on the previous phase, we picked the most promising interaction concepts.
- **Design Concepts:** We turned the identified concepts into scenarios. We considered the most crucial key elements of the interaction, from the users' perspective. After presenting these scenarios to project partners, we created both paper-based low-fidelity prototypes as well as high-fidelity ones through a toolkit specifically created for this purpose (see Figure 66).
- **Evaluations:** To ensure improvements in usability for each of the design iterations, we conducted evaluations throughout the process. For our low-fidelity prototypes, we chose methods to evaluate the usability of our system (Nielsen, 1992). For evaluating the interaction on the actual façade, we additionally adapted UX methods (Burmester et al., 2010) to cover a holistic investigation of the users' actions and emotions.

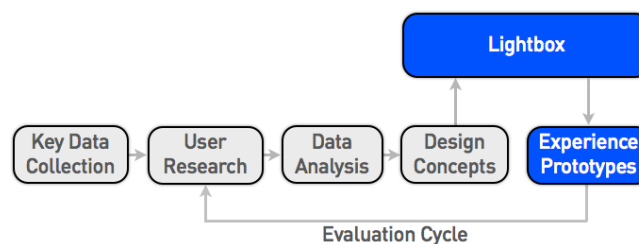

Figure 66. *Lightbox* as a design process extension that aids the pre-testing of content and hardware components utilized for media façade interaction.



8.4 User Research

To obtain a better understanding of how potential users perceive our initial design ideas, we conducted a series of interviews in the field. To explain a complex, emerging technology to passersby in a short timeframe, we conducted the interviews next to the lit-up façade of the ARS Electronica Center in Linz, Austria⁶², which was also the site of the actual installation. Each of these semi-structured interviews lasted 15 minutes and was videotaped. In total, we conducted 48 interviews with passersby at the façade (average age was 27 years). We structured the interviews in three consecutive phases: after a short introduction to media façades and interaction models, we discussed (a) whether they were in favor of any envisioned applications and (b) whether they would consider using them if implemented. We confronted them with early design ideas that covered a broad range of interaction possibilities: interactive games, painting with light on the façade, music visualizations, city mobility animations depicting traffic in real time or façade visualizations triggered by full-body interactions. Overall, we received positive feedback that interacting with a media façade presents an interesting opportunity. For example, a 30-year old female interviewee stated: “It is an interesting aspect. Why should a façade be plain grey when instead it could be used to interact with multimedia content?” We also recorded critical statements concerning the envisioned interaction in a city’s public space. A 36-year old male commented: “I would not appreciate everyone playing around with the façade, especially for the residents’ sake.” However, the two critical responses were outnumbered by 46 participants who had general interest in the overall concept and stated that they would participate in further experiments with interactive prototypes (Wiethoff and Gehring, 2012).

62 <http://www.aec.at/>

8.5 Low-Fidelity Prototyping

8.5.1. Concepts

During the user research phase, we identified two interaction concepts that were consistently mentioned positively during our semi-structured interview sessions:

- (1) A mobile spray-paint application that enables users to change the façade's color using a touch-screen device.
- (2) A jig saw puzzle that requires users to rearrange colored tiles to a pre-defined order on the media façade. Based on these concepts, we created three different GUI variations which we present in the next section.

8.5.2. Paper Prototyping

To explore and pre-test variations of potential graphical interfaces for the two applications previously described, we conducted an initial paper-prototyping session with five participants (one female, average age 27 years). All participants were recruited from a tech company, which was also where we held the sessions. All participants rated their expertise with mobile devices and emerging technologies as *high*. We documented the paper prototyping sessions on video and took additional photographs of the setup.

We instructed the participants as follows: First, the experimenter explained the intended project and the envisioned applications in five minutes. The experimenter simultaneously showed imagery of the ARS Electronica media façade⁶³ in order to give the participant a better understanding of the project. Subsequently, we asked participants to imagine interacting with the façade using an iPhone. The participants were asked to complete two tasks with each of the three paper prototypes. Both the tasks and different prototypes were assigned in random order. In the first task, they had to locate the color selection tool, pick a specific color and *apply* it to the building (i.e., by sweeping over the paper image) from the bottom right to the upper left corner.

63 <http://www.aec.at/>

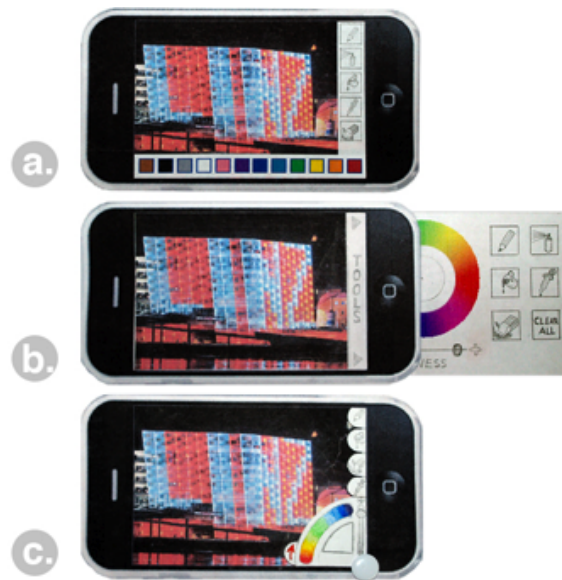

Figure 67. Three different interface solutions as paper prototypes. Top: Tool elements and color selection in one screen. Middle: Tools and color picker on multiple screens, accessed via a slide gesture. Bottom: A combination of the previously described GUI approaches. Basic functionality in one screen, additional features accessed by sliding. (Wiethoff and Gehring, 2012).⁶⁴

The second task required locating the color selection tool, selecting a specific color, locating the filling tool, *activating* it by touching the icon and *applying* it to the façade by tapping the image's center. For each task, we encouraged our participants to use the think-aloud technique (Nielsen, 1992) while interacting with the paper prototypes. After the experiment, we interviewed the participants and asked them about their experiences during the session.

Assessing the interface that was easiest to use, (ease-of-use) three of the five participants voted for the interface containing all elements in one screen (see figure 67a). Two users preferred the solution with all GUI elements accessed via a slide gesture (see figure 67b). No one opted for the third solution, a combination of both approaches, as depicted in figure 67c. Similar results were found when we asked participants which design they considered the most appealing.

The color selection tool presented a crucial part of the interface and varied the most in each prototype. For this reason, we asked our participants more detailed

questions about it. The majority of the participants (four of the five) favored the hue, saturation and value (HSV) color wheel, accessed via a swipe gesture, (see Figure 67b), as it “offers the most freedom for choosing a color”. Only one subject preferred a fixed color palette with selected colors (see Figure 67a). Again, the hybrid interface solution (see Figure 67c) was considered the most complex and hence ranked last.

This exercise helped us decide on general directions for further development of the GUI components. Even with our results, however, we were now confronted with the challenge of creating a high-fidelity, interactive experience prototype to test our vision. With the façade only operable for a few hours per day, and since it was frequently in use by others, we had to create a prototype that does not require access to the façade but that creates a similar appearance. To address this challenge, we created a mobile experience prototyping toolkit.

8.6 Lightbox

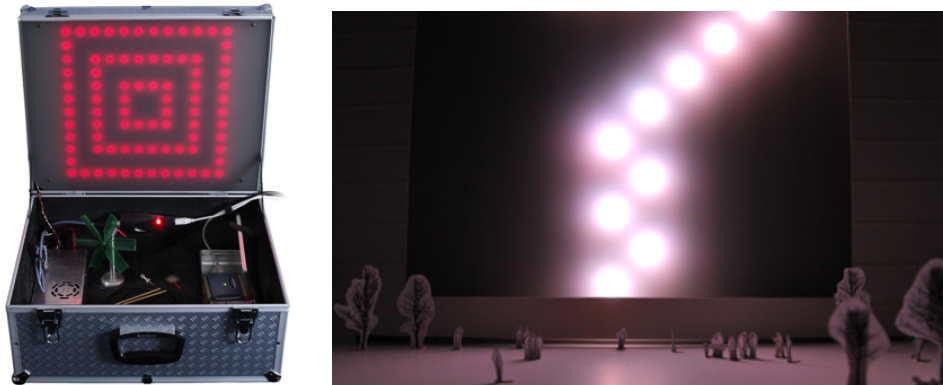

Figure 68. Pre-testing design concepts using *Lightbox*, a mobile experience prototyping toolkit to simulate media façade interaction (Wiethoff and Blöckner, 2011).⁶⁵

It is a rather difficult and challenging task to imagine how content will appear from different viewpoints (and in low resolution), if displayed through multicolored light emitting diodes (LEDs) as depicted in Figure 64. For this reason, we decided to build a miniaturized version of the actual façade’s components that allows for exploring both possible applications as well as the

⁶⁵ Photos © (from left) Magdalena Blöckner, Alexander Wiethoff

interplay of the involved hardware components, without deploying the system on the actual façade.

Lightbox (Wiethoff and Blöckner, 2011) consists of an aluminum box measuring $48 \times 38 \times 25$ cm. The box's lid holds a panel of 12×12 LEDs, created with 12 single 24V / 10W high power colormix RGB LED strips (see figure 68). We chose this setup as it closely simulates the low resolution of the ARS Electronica Center façade (see Figure 64, right). The LED strips are controlled through DMX signals, an industry standard for controlling lights which is also used at our target façade. Furthermore, the box contains a PC running custom software, as well as a 24V and a 9V power supply to power and control the LED panel and experimental setups (Wiethoff and Blöckner, 2011), (Wiethoff and Gehring, 2012).

Using this prototyping toolkit, we implemented the previously described *paint application* (see figure 68) together with a mobile device (here, Apple's iPhone 3G), allowing users to paint multicolored light on the LED panel via touch input.

At this point, we were able to investigate two fundamental aspects of the system:

- (1) The interplay of technical components (i.e., iPhone, Wi-Fi router, application server, DMX lighting system, and LED lighting elements) in general, and, more specifically, their interplay without any delays. We considered real-time feedback a crucial aspect with respect to usability, as users may perceive a system with even minor delays as faulty and unpleasant.
- (2) To judge whether the generated lighting colors matched the GUI components and if our applications were still presented recognizably in such a low resolution.

We investigated the usability of the GUI concepts depicted in Figure 67 a-c under similar conditions as in the low-fidelity setup previously described. The preliminary results from the paper prototyping session were confirmed and are therefore not extensively discussed.

After several performance evaluations with the prototyping toolkit from a hardware perspective, we were ready to deploy our applications on the actual façade (Wiethoff and Gehring, 2012).

8.7 High-fidelity Prototyping

We conducted the final experiment on the façade of the ARS Electronica Center (see Figure 64, right). Its 1087 windows (addressable through DMX) host approximately 40000 LEDs. The size of the building allows a viewing distance of up to 300 meters, with an optimal distance of around 50 meters. To allow interactions and manipulations on the façade, we adopted the concept of interacting through live video at-a-distance (Boring et al., 2010).

The implemented system runs on a camera-equipped mobile device (here, Apple iPhone 3GS) that turns it into an interactive see-through panel (see Figure 69b). All mobile clients are connected to a server that manages both tracking mobile devices and coloring the façade. Input from live videos on mobile devices is forwarded to the server, which then applies the interaction to the façade.

For the final experiment, we created an application that allows users to freely *paint* on the façade in a collaborative or competitive fashion. To avoid visual clutter on the shared canvas, we distributed the content as follows:

- (1) Content relevant for all users is shown on the façade.
- (2) Individual content (e.g., tool palettes) is only shown on the mobile display of the particular user (see Figure 69b).



Figure 69. (a) Users can interact on the entire façade using their mobile device. (b) They choose their individual color and tool and apply these to the façade directly through live video (Boring et al., 2011).⁶⁶

To keep the interaction canvas as large as possible, controls and tool palettes are shown on demand by performing a sliding gesture, as this was the favored design concept for color selection in the low-fidelity prototyping phase. During the

⁶⁶ Photo © Sebastian Boring

experiment, up to three users (we ensured that at least two interacted at the same time) simultaneously painted on the façade without any restrictions (i.e., every pixel of the façade was accessible at any time for each user). The façade was shared on a first-come, first-served basis (Wiethoff and Gehring, 2012), (Boring et al., 2011).

8.8 User Study I

To further improve the usability of the GUI on the mobile device, we conducted an additional preliminary study. In contrast to the former experiments, this evaluation was conducted

- (1) On-site.
- (2) Under real conditions.
- (3) With each of the user interfaces of the paper-prototyping sessions implemented (see figure 67 a-c). The software ran on an iPhone 3GS and on a computer connected to the lighting system of the façade.

8.8.1. Setup

The six participants (one female, average age was 30 years) received a three-minute introduction to the application. Then, we explained each of the GUIs with their additional functions (tool palettes). The participants did not receive any up-front training with the system. We instructed the participants to interact with the application and perform three pre-defined tasks with each of the three user interface prototypes. The order of presentations for the prototypes was randomized using a 3 x 3 Latin square.

- **Task 1.** Locate the *color selection tool*, select a given color (e.g., bright green), and paint a line onto the building's façade. Subsequently, select another color and paint a line.
- **Task 2.** Locate the *color selection tool*, copy-paste an already visible color on the building (i.e., pipette tool), and fill the whole façade.
- **Task 3.** Locate the *erase feature* in the tool palette, select single windows (i.e., pixels) on the façade, and clear their color by tapping on each of the windows.

8.8.2. Preliminary results

After finishing the tasks, we asked the participants to fill out a questionnaire with 12 questions (5-point Likert scales, ranging from 1, meaning “totally disagree”, to 5, meaning “totally agree”) about the prototypes’ usability.

In summary, the participants preferred having the control elements separated from the actual painting screen and accessing them with a sliding gesture, since they enjoyed this GUI feature the most. One reason for this preference was that most of the participants claimed familiarity with the gesture and platform. Although the interface with one screen and buttons for selection of predefined colors (see Figure 67a) was again ranked highest in terms of ease of use with a mode of 5 (four times) compared to interfaces depicted in Figure 67b with a mode of 4 (3 times) and the one depicted in Figure 67c with a mode value of 3 (3 times), (see Figures 67b-c), on 5-point Likert scales ranging from 1-5, with 5 representing the easiest to use, the participants preferred the interface depicted in Figure 67b as their overall favorite design concept, including the controls on a separate screen (mode=5) in contrast to the interface prototypes depicted in Figure 67a, (mode=3) and Figure 64c (mode=2).

With the data collected from this setup we were able to

- (1) Choose the final design of the interface.
- (2) Improve its usability for the final setup.

However, the data gathered in this process phase was targeted towards aspects concerning the general usability of the system. As a result, we did not collect any data on the users’ experiences while interacting with the media façade.

Thus, in the following setup, we investigated the users’ deeper underlying motivations when interacting with such a system using UX methods as the means of evaluation (Wiethoff and Gehring, 2012).

8.9 User Study II

8.9.1. Setup

To address the initially discussed challenge of evaluating the interaction with a media façade more holistically, we designed our method as an adaptation of Burmester et al.'s approach (Burmester et al., 2010): Users received a three-minute introduction to the system and its features (as before). We then instructed users to take a *mental note* of both negative and positive experienced emotions with each occurrence. All participants were recorded on video during the actual task for later analysis.

Users were finally asked to interact with the building using the aforementioned spray-paint application for exactly five minutes. During this phase, users were allowed to freely pick a color from a palette and spray-paint the building in different colors and patterns. Immediately after the interaction phase, we interviewed each user for 10 minutes. The interviews were audio-recorded for later analysis. We used an investigative two-step interview process based on the Laddering technique (Reynolds and Gutman, 1988), deducing the fulfilled needs based on positive emotions.

We started each question by directly referring to the *mental notes* in which users remembered a positive or negative emotional aspect during the interaction phase. Based on these mental notes, we asked them to explain the reasons for their reactions. For example, one user stated that he enjoyed the freedom of picking, mixing, and applying any possible color to the building. Based on this statement, we continued to ask why he perceived this experience as positive. He stated further: “Because I can do it completely by myself and it does not happen automatically.” We recorded these statements and allocated them to a specific positive need, based on classifications of specific human needs in correlation with technology (see figure 70), as set out by Sheldon et al. (Sheldon et al., 2001). In this case, the allocated need was mapped to two needs: autonomy and competence. These were suggested by the expressed keyword phrases “do it by myself” and “not automatically” during the second phase of the interview.

The second evaluation cycle focused entirely on the users' experience of the interaction. We conducted the experiment on two consecutive days during the ARS Electronica Festival (one hour each). Out of 50 users interacting with the façade, we interviewed 15 (five female; average age was 26.1 years) for the

investigation of UX purposes. Each interview lasted 10 minutes, while the users had 5 minutes to experience the system beforehand. Again, all participants were recorded on video during the interaction and interview phase for later analysis.

8.9.2. Preliminary results

Figure 70 lists the analysis and classification of confirmed needs gathered from the interview data. Apart from the obvious result of participants having fun while interacting (eleven were allocated to pleasure stimulation category), the most interesting result was that 12 of 15 participants expressed statements that were mapped to the need for competence.

In the second part of the interview, we analyzed the reasons why this need was fulfilled: Participants felt empowered to accomplish something technologically complex (from an outside perspective) while others were watching. After analyzing the transcript interviews, we concluded that 10 participants felt confirmed in their need for autonomy, as our system allowed them to interact simultaneously or alone, according to the users' choice, indicating that the autonomous operation of the system was considered quite important by the majority of the participants. The need for relatedness was repeatedly mentioned by 8 participants in the second phase of the interviews through quotes such as: "We were able to simultaneously communicate with the person next to us while interacting, which made it indeed a richer group experience."

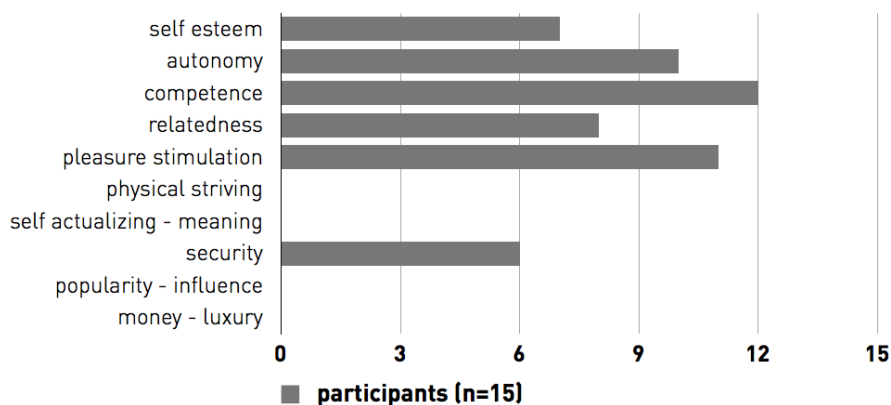

Figure 70. Identified confirmed needs after the laddering technique interview from 15 participants (Wiethoff and Gehring, 2012).

Here we considered the (a) communicational aspect and (b) mentioning a shared group experience as adequate keywords for an appropriate mapping to a specific need (Sheldon et al., 2001), (Wiethoff and Gehring, 2012).

8.10 Discussion of Findings

In summary, we reported our experiences while designing, prototyping, deploying and evaluating a system for remote interaction with media façades. We tested and explored the applied concepts and the utilized hardware with a prototyping toolkit that was tailored to the properties of the façade and the deployment context. With the aid of the prototyping toolkit, we addressed aspects that were crucial for the later deployment of the system on the actual media façade. It allowed us to pre-test content and hardware on a small scale without facing the limitations previously highlighted.

During the evaluation cycles, a consideration of the users' experiences through the preliminary use of UX methods in the second evaluation cycle led us to results that covered users' experiences more holistically. However, in a further setup, the method of referring to a *mental note* could be simplified by, for example, providing additional buttons integrated in the interface that would trigger a log mechanism. In this way, the allocation of the mental note, which incorporates important aspects about the users' experiences in a specific moment in time, can be tracked more accurately during the interaction and subsequently serve as the basis for the mandatory follow-up interview.

We believe that, when compared to traditional GUIs, these measures are more critical when dealing with media façades and should therefore be taken into consideration. At the same time, methods targeted at improving general usability, as applied in the primary evaluation cycle, are also highly valuable. They provide the basis on which the experiences happen in the first place. Based on our initial research on this topic, we recommend using methods that equally consider both factors and thus lead towards designing usable and enjoyable interactions in this domain.

By using available off-the-shelf hardware components to pre-test our implementations, we provide others with the opportunity to replicate our course of action when facing similar challenges. However, the chosen approach of miniaturization in this context strongly depends on (a) the lighting elements used by the façade type and (b) the appropriate scaling of the resolution that should be taken into account. Further, we applied UX evaluation methods in this design context as preliminary experimental setup (Wiethoff and Gehring, 2012).

8.11 Summary and Contributions

In this section, we reported on our experiences designing interaction with media façades. We described our results combining and adapting evaluation methods to obtain a method suitable for covering both improvements in usability as well as revealing insights on users' experiences interacting with this form of interface. We extended standard user-centered design processes: developing a prototyping toolkit that allowed pre-testing content and hardware as well as simulating the conditions determined by the deployment context early in the design process. The results obtained had a direct impact on the further process. We iteratively derived a combined and adapted evaluation approach that covered both areas in order to have the ability to evaluate all aspects that are important for a successful system (Wiethoff and Gehring, 2012).

Classification

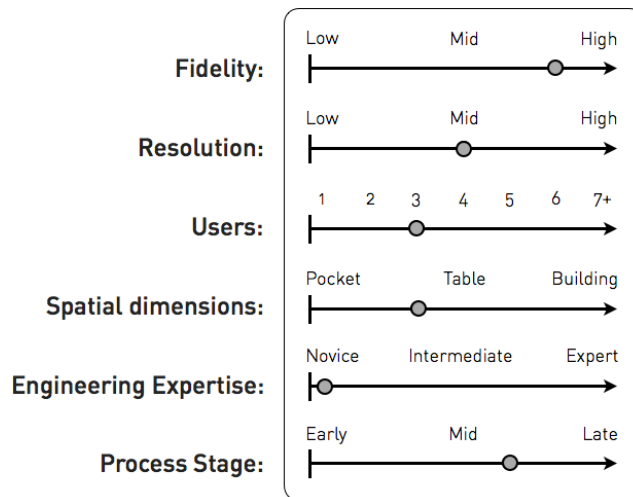

Figure 71. An overview of some of the most important parameters for *Lightbox*, a prototyping toolkit extension (see Figure 68).

To summarize the visually expressed parameters depicted in Figure 68 in more detail:

- The presented toolkit is a high-fidelity due to standard industrial components that do not differ from the actual implementation, apart from the size (e.g., a media façade).
- The resolution, however, operates at moderate levels as the elements remain fixed and cannot be easily modified to allow more design details in the actual physical representation.
- The toolkit allows a maximum of two users to operate it simultaneously, owned due to the spatial components and implemented software.
- The spatial dimensions of the prototyping setup do not exceed the measurements described in section 8.6. Thus, the toolkit remains easily transportable to various places that support the pre-testing phases.
- Even novice users can operate the toolkit, due to the developed software components that incorporate tutorials, GUI elements and no prior knowledge about electronics or coding environments.

- We consider the toolkit a valuable aid in intermediate phases of the design process, when a design team is in the process of investigating several design concepts on both hardware and software components while also conducting performance testings.

V.

Discussion, Conclusion and
Future Work

*Design is about problem solving, not about personal preferences
or unsupported opinion.*

Bob Baxley

9. Discussion and Conclusion

In this section, we summarize the studies we conducted along with a discussion, conclusions and future work. In the first part of this section, we retrospectively reflect on our case studies and experiments. We share positive aspects along with critical reflections. In the mid-part of this section we discuss remarks on methodology and interaction design that are strongly tied to studies that will be conducted in future settings. We further discuss novel challenges and trends that will affect the design interaction process in the near future. In the remainder of this section, we provide a conclusion of the undertaken approach, along with an outlook on current explorations and future investigations.

9.1 Summary of the Process

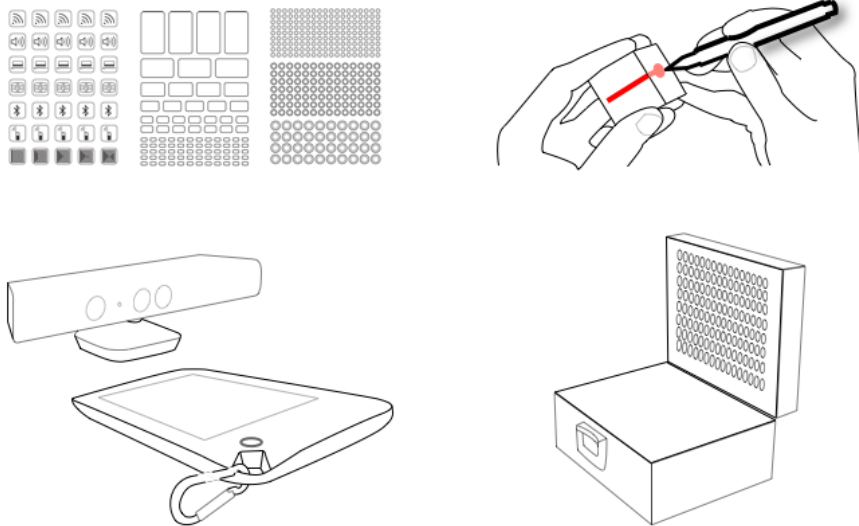

Figure 72. Examples of the discussed toolkits for systematically prototyping tangible and intangible interaction forms more effectively.

In this thesis, we presented toolkits of different fidelity levels to extend interaction design processes (see Figure 72). Our goal was to help designers better prototype hybrid interactions in a cost- and time-effective way while performing more design iterations and *getting the design right*. The created toolkits are suggestions for how to systematically prototype hybrid interactions while considering both **tangible and in-tangible** interaction forms (see Figure 72 & 73).

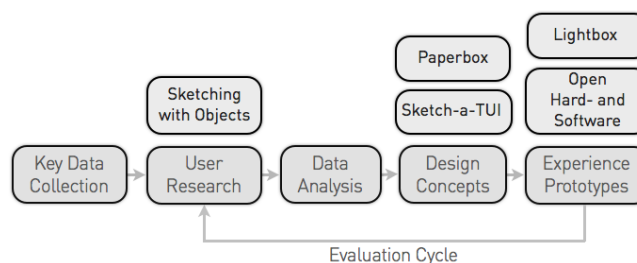

Figure 73. The implemented design process extensions presented in this thesis.



In summary, all of our toolkits share common aspects and properties:

- They support the creation of prototypes in difficult design contexts by **providing possible starting points**.
- They fit into standard interaction design processes at different points (see Figure 73).
- They can be used by interdisciplinary teams and support communication as **process facilitators**.
- They enable the **rapid exploration** of a novel and challenging design context.
- They help design teams find **appropriate mapping** for the embodied or physical manifestation of the interface and the interconnected digital behavior, which in turn supports the (design) process of making these interfaces **comprehensible to potential users**.
- They allow design teams to **work their ideas through** in a practical manner, especially when compared to a design process approach that relies merely on theoretical discussions or conceptual presentations.

Design teams can consider these extensions in the form of toolkits to be a source of inspiration for initiating their design processes in difficult contexts and pushing them beyond their own expectations by using tools on different fidelity levels at different points. We showed how these tools could be practically applied in individual case studies that were strongly tied to given tasks with individual (interaction) design objectives. However, collectively, the applied toolkits can serve as a list of possibilities regarding which tool would be best for any given context. Design teams can, for example, refer to the tools depicted in Figure 72 & 73 and deliberate about whether one or a combination of our tools and approaches suits their design objectives. In this sense, our toolkits also invite others to create extensions and develop them further. On the contrary, our prototyping toolkits can also be considered prototypes themselves. This circumstance suggests that through iterative improvement these tools can be further extended and refined. Through further case studies by other users, we can gather additional insights into which of these tools is best suited to a given task. The knowledge generated from such exploration can potentially:

- Lead to the further improvement and extensive use of the proposed toolkits.
- Provide insights into how the tools are used in other contexts.
- Partial or total abandonment of the implementations.
- Completely unexpected use of our extensions.

All of the created toolkits helped us pursue the goals we wanted to achieve in the context of this thesis. Throughout this thesis, we also followed an interaction design process, such as the one depicted in Figure 73, for envisioning creative, iterative testing and evaluating our approach:

- **Key Data Collection:** We performed extensive desk research in the area of tangible and intangible interactions, design processes, prototyping methods and tools as described in the related work section (see Section II) that served as a basis for further process steps.
- **User Research:** In the first iteration we observed interdisciplinary workshops and field studies in the industry in order to gain a better understanding of the given context as well as a deeper understanding of recurring problems, routines and opportunities for supportive toolkits (see Section 3). In later iterations we collected data in field studies for each of the presented design contexts (a) to gain a better understanding of the individual contexts and (b) to tailor our prototyping extensions to the scope of the chosen design space.
- **Data Analysis:** We analyzed the data gathered in the user research phases and summarized potential opportunities for supportive toolkits in various design contexts.
- **Design Concepts:** Based on our main findings we created a variety of concepts for potential toolkits and turned the most promising ones into prototypes.
- **Prototypes:** We aimed at creating alternative auxiliary means for prototyping hybrid interactions more effectively. To do this we introduced five different prototyping toolkits that were intended for different process phases (see Figure 73). We created *Sketching with Objects* as a means for inspiration and the creation of mockups in the very early phases of ideation and user research. *Paperbox* and *Sketch-a-TUI* were used for support during (design) concept generation in the realm of tangible interaction on interactive surfaces. In a case study on how to prototype novel interactive systems that incorporate the use of an intangible interaction mechanism, we investigated the suitability of *community supported hard- and software components* as an auxiliary means of support during the experience-prototyping phase. In the context of intangible interaction we introduced *Lightbox* as a means of supporting the experience-prototyping phase in the context of a project dealing with media façade interaction.
- **Evaluation:** We observed the way our toolkits were used in the design process by conducting field studies and observations *in the wild*. We investigated how our first implementation *Sketching with Objects* was

applied practically in an industrial context and helped an interdisciplinary design team to express their interface ideas and communicate complex interaction design relationships to end users in early process phases (see Figure 73). This was undertaken in field studies at a large museum of contemporary art in coordination with potential users.

Paperbox was initially tried out in two exploratory user studies, in which we observed the way this toolkit enabled the envisioning of interaction concepts for TUIs. We then used participatory design methods to evaluate the tool further and implemented promising concepts resulting from a previous ideation session. For the implementation, an interactive surface served as a contextual framework for further investigations.

Sketch-a-TUI was inspected in an industrial design studio where designers created new products for their portfolio with the aid of the toolkit. We used a series of expert reviews to gain first-hand insights into which design activities native to the toolkit could best support designers and which activities were not useful to them. We further explored the use of the provided toolkit to evaluate whether usability studies can be performed even with tangible low-fidelity artifacts through formal experimentation in coordination with potential users (see Figure 73). The additionally created iPad application *Sketch-a-TUIApp*, which does not require previous coding experience when using *Sketch-a-TUI*, has been finally investigated in an industrial context through additional interviews with experts in various design studios.

The suitability of *community supported hard- and software components* for prototyping has been investigated through expert evaluations and through prototyping a touch-less operating system that was seamlessly transferred to the actual prototype. The adaptation of a method for inspecting the *immediate usability* of a system served as a means of evaluation with which we conducted a series of studies and investigated how well the final system performed during formal experiments in coordination with potential users.

The mobile experience-prototyping toolkit *Lightbox* has been investigated through the use of the toolkits in the experience-prototyping phase (see Figure 73) and been revealed as valuable for these purposes due to the immediate transferability of the pre-tested interaction and hardware components. We tailored and applied suitable evaluation methods from the field of UX to our context and used them to cover the users actions and emotions more holistically.

- **Dissemination:** Through publications, tutorials and video documentation made available to the community (in the form of online archives and blogposts), we intend to share our toolkits and make them available for further development and replication.

9.2 Summary of Findings

As discussed in Chapter II of this thesis, designing novel interfaces which incorporate interaction forms that differ from traditional screen-based interactions confronts design teams with new challenges (see Section 2.6.1 & 2.6.2). As a result, traditional prototyping methods have to be altered or extended to suit the context of use. We investigated the practical use of these process extensions in several case studies that were conducted in industrial contexts.

Reflecting on our experiments, we conclude that the provided extensions in the form of toolkits proved beneficial to the participating design teams: During the field research phases, we observed that the participating teams utilized these alternative stimuli to explore early instantiations of their ideas, which empowered them to perform more design iterations.

Further, the provided process tools helped them **work through their ideas** in a more practical manner than a design process that relies on theoretical discussions and two-dimensional process artifacts (e.g., renderings) that **do not support interactive experiments**.

We introduced these toolkits as auxiliary means to assist design teams in difficult contexts such as the one presented here. By creating and sharing our toolkits, we suggested various novel extensions at several points of the design process while incorporating different characteristics.

On the other hand, the creation and successful implementation of new interaction forms using interaction design process methods demands an interplay of various disciplines to reach a usable and enjoyable outcome (see Figure 71). We observed that our implementations can provide design teams with even more support than explorations of concepts and help in creating interactive mockups: During our initial field research on current design practices, we noted that the communication between the disciplines in question (see Figure 71) was not always successful and in some cases hindered the collaboration necessary to accomplish the project successfully (see Section 3.1). Here, we experienced our implementations as valuable process mediators that helped interdisciplinary

teams continuously focus their communication on the design context while still being open enough for ambiguous interpretation, thereby fostering diverse discussions (see Section 6.3.3 & Section 6.11.1).

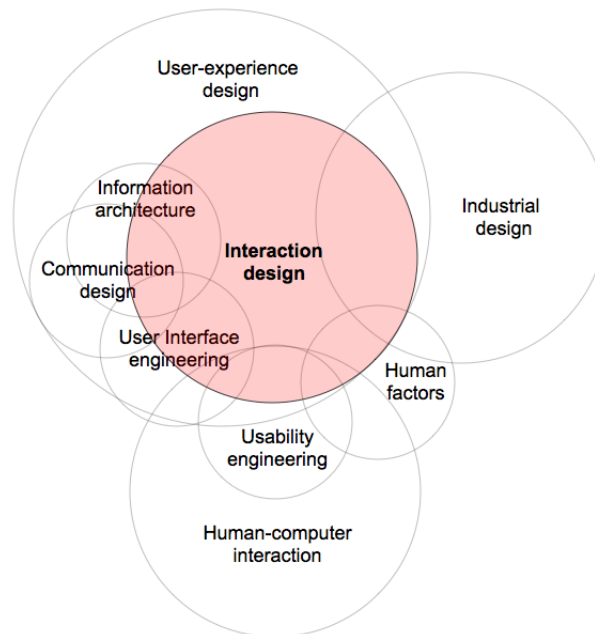

Figure 74. An overview of the many disciplines involved to interaction design practices (Saffer, 2009).

However, applying our toolkits in industrial contexts was not always an easy task. In one case study, for example, we experienced that many designers stuck to their routines and were suspicious of leaving their trained habits and beaten paths. They first had to be convinced of the benefits before wanting to try out new process routines and practices. Thus, the tutorials that accompany such implementations play a significant role that should not be neglected. They can cause users to rejection of the process tools if not carefully thought through. As a consequence, we recommend that these tutorials should (a) incorporate references to how such process extensions can be practically utilized and, even more importantly, (b) include clear indications of their *value* for the design team. Otherwise, the best toolkits face the hazard of being underused and finally forgotten.

Furthermore, we suggested these toolkits for individual cases and assisted in these projects with purpose built alternative auxiliary means. Hence, in this respect, we can only draw our conclusions for these individual cases and not judge the transferability to other circumstances. Our toolkits were used in standard interaction design processes. They proved to be beneficial because they provided design teams with possible starting points in a fairly large design space. Therefore, we can only recommend taking design process extensions such as those described in this thesis, into deeper consideration when designing hybrid interactive systems. With this thesis, we have shared inspirations on how **tools for prototyping hybrid interactions** can look and be **practically applied**.

As has already been pointed out, in the context of tangible or intangible interaction, each of the described cases has an almost infinite opportunity space for novel interfaces and interaction systems. Hence, an investigation of each of these individual cases can lead to more profound knowledge on how to effectively envision, create, pre-test and implement these systems in a timely and cost-efficient manner and allow more frequent design iterations by more people. By disseminating our results, we hope to inspire other design researchers, artist and practitioners to take up our approach and enrich the community knowledge through the creation and documentation of additional toolkits (see Figure 75).

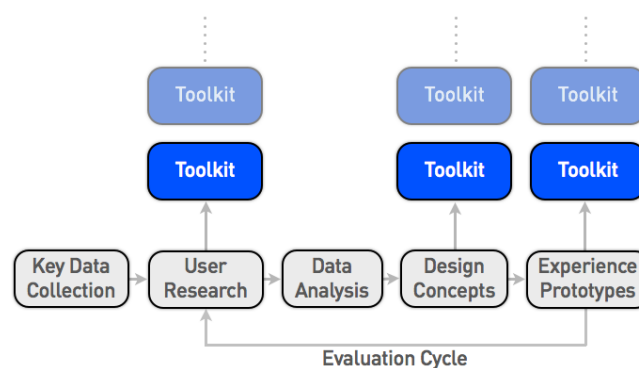

Figure 75. The creation of several additional toolkits can serve as a valuable reference for design teams in *wicked* (Rittel and Webber, 1984) contexts.

We foresee an entire shelf of tools (see Figure 75) to be used for many contexts in the future and our implementations can pave the way by inspiring others to

reconsider how an extended design process looks, particularly one that relies on prototyping both time- and cost-effective hybrid interactions.

9.3 Remarks on Methodology

To evaluate our implementations, we utilized various forms of methodology: Depending on the context, we relied on evaluation methods that comprised a spectrum of quantitative (e.g., task completion time, error rate, etc.), qualitative (e.g., Likert scale questionnaires, diary studies, semi-structured interviews, etc.) and user experience related metrics (Hassenzahl, 2010). However, the HCI community is still in the process of discussing standards in this area, as shown by pertinent publications (Barkhus and Rode, 2007), (Bargas-Avila and Hornbaek, 2011) and online discussions⁶⁷ on these matters.

In this respect we also consider that new types of interfaces demand their own tailored evaluation methodologies in order to systematically *grasp* their capabilities more holistically.

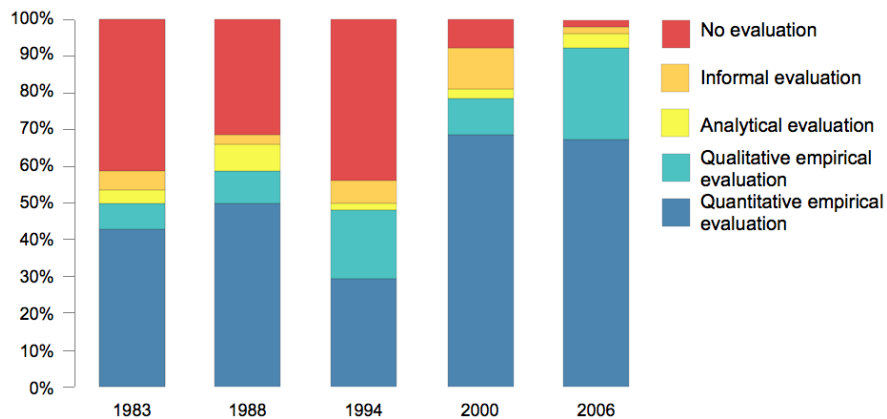

Figure 76. An overview of CHI⁶⁸ publications and the utilized evaluation methods, considered in a 23 year time-frame (Barkhuus and Rode, 2007).

As the work by Barkhuus and Rode (Barkhus and Rode, 2007) exemplifies, there is a trend occurring in the HCI community from a reliance on mere quantitative

⁶⁷ <http://www.acm.org>

⁶⁸ <http://www.sigchi.org>

evaluations to incorporating also qualitative techniques. This tendency can be seen in more recent publications (see Figure 76). Further, comparing publications that were published over two decades ago to more recent ones, we see that a large number of publications don't include evaluations whatsoever (see Figure 76). However, more recent ones do not seem to get published without presenting a proper study description. On the one hand, we appreciate this shift as it makes the comparison and replication of studies possible, however, on the other hand it demands a careful consideration of how and when to apply measurements in the design process. In their work on usability evaluation, Greenberg and Buxton (Greenberg and Buxton, 2007) state that a misuse of the applied techniques can be even contra-productive for the final outcome and hinder innovation and creativity: *“Usability evaluation, if wrongfully applied, can quash potentially valuable ideas early in the design process, incorrectly promote poor ideas, misdirect developers into solving minor vs. major problems, or ignore (or incorrectly suggest) how a design would be adopted and used in everyday practice“* (Greenberg and Buxton, 2007).

We argue that each novel interaction mechanism requires considerations about how to design, prototype and, equally important, **evaluate such cases**. In our final case study, described in section 8.2.5, we provided insights on how we systematically tailored methods from the field of UX to suit our contexts. The incorporation of this method revealed a **broader perspective** into the context and covered the underlying motivations of the users' interactions with the system more holistically. However, the standard usability methods (Feng et al., 2009) used in the initial part of the study, served as valuable tools to improve the usability and hence, paved the ground for the use of additional methodologies.

Dedicated research investigation could categorize this segment and provide aid for researchers on which method would be suitable for specific design contexts. In this respect, we think that deeper explorations in this realm can provide starting points for future work that investigates hybrid interaction systems more holistically. Individual case studies can provide different combinations of methods and identify the most promising methods for the given design contexts.

In sum, we experienced that conducting investigations in novel and *wicked* (Rittel and Webber, 1984) design contexts raised new challenges when compared to closed environments (see Section 8.1), especially designing suitable evaluation methods according to the domain specific challenges that these environments present. Thus, we argue that an investigation of the **domain-specific challenges** should be conducted even before designing an appropriate evaluation methodology as it strongly coins the setup.

9.4 Additional Challenges in Interaction Design

Apart from the described interaction design process models and the provided extensions, we believe that more factors will influence this domain in the near future. This will also demand deeper considerations that affect the processes that we discussed. One aspect is the social-cultural impact that new systems will provide. Here, ethical considerations will demand deeper considerations and, as a consequence, influence design decisions.

Currently, we can observe novel types of interface solutions that provoke critical discussions beyond privacy concerns: Wearable mobile systems or technology implants are prominent controversial examples that are currently being discussed. Critical recipients question the blurred or even fused boundary between digital and real worlds and the implications for the users' behavior. The same applies for other concurrent projects, for example, one that predicts users' next actions based on their behavioral patterns.

Taking discussions on ethical considerations into account also questions new methodologies for the people who design and implement these systems. The same applies even to educational matters. If the previously mentioned aspects play a more important role in the devices and services of the future, individuals that are responsible for the creation of the (interaction) design need to also acquire profound knowledge in these areas in order to make good decisions that support users.

Finally, the question of how the long impact of technology is related to these aspects is still open. What will happen to the users' data in the future (e.g., 100+ years) ? Can interfaces make wise choices by themselves about what users need to see in a specific moment in time and what information can be neglected, based on their histories ? Who is in control over technology that affects large audiences at specific points in time? (One example of such a technology is explored in our final cases study, exemplified in Section 8.7). All of these questions demand further explorations for interaction design and present future research needs.

9.5 Ongoing and Future Work

We plan to further substantiate our approach in the near future. One project we are currently pursuing takes up several of the still outstanding challenges that were previously discussed.

9.5.1. Supportive toolkits

In one project, for example, we are in the process of building a new prototyping toolkit to explore remote interfaces. In the context of this project, we will build on knowledge gained through the experiences presented in this thesis:

The system we are developing will consist of a different characteristics as the ones presented in this thesis. We are targeting interactions that incorporate also different output media. Using this technology, we have new design opportunities that we didn't have with the with the ones presented here. However, design for these contexts also raises new research questions: Can we (re-) use the tools that were created in our past projects to design a new interactive system in new domain(s) ? What kind of interaction technique is the most appropriate for these novel contexts that include, for example, also haptic feedback types ?

To investigate these matters, we will judge the transferability of the methods used in previous settings and aim at reporting comparisons between different prototyping means. Further, we plan to work with additional toolkits. One idea we want to explore is incorporating rapid prototyping techniques and miniaturization: We will use rapid prototyping techniques to create miniature versions of the actual interfaces. By doing this we aim to emulate the real technology setup to per-test content and hardware for each test setting before transferring both on the actual scale.

9.5.2. Evaluation

Another part of our next projects will cover the design of guidelines for evaluations and interaction models. As the nature of the interfaces we are planning to work with have the opportunity of delivering multimodal feedback, we will be able to deliver information through alternative stimuli. Here, we will further investigate multi-user aspects of hybrid interaction forms. One outcome of our previous experiences in the field (see Section 8.9.2) is that the multi-user

aspect also raises a prominent research question: How is temporary ownership negotiated?

In one case study, we witnessed that the interaction in groups can lead to either frustration or enhanced group experiences, depending on whether the participants knew each other or not. This is an interesting finding for future work, as it raises the question of who, at which time, is in control over the interface and for how long? We want to test and try different role models with control mechanisms when interacting. One approach is considering *political* metaphors that can consist of, for example, a *monarchy setting* with only one person being constantly in control vs. a *democratic model*, in which users have to vote and agree on the temporary ownership of the interface in question. By conducting several parallel exploratory setups and comparing different methods, we aim at producing data that can help us draw conclusions for these cases.

However, such settings also raise the question of how to systematically tailor a specific evaluation method. Our initial investigation into this domain revealed that the parallel use of different methods were also capable of providing a more holistic picture of the users' underlying motivations and emotions (see Section 8.9.3). For this reason, we are planning to conduct an experimental investigation of evaluation methods in parallel and thus find the appropriate method for individual contexts.

9.5.3. Future Work

The research we have conducted paves the way for further investigation and exploration. Our implementations can serve as starting points for additional research. One aspect we consider highly beneficial would be an application programming interface (API) for our implementations. We believe this would be a promising step for users of these toolkits who can then tailor the tool even better to their needs. It could be combined with visual programming languages (e.g. vvvv, max msp, etc.) to allow even those design teams with limited programming skills to develop their own applications and tweak the tools to their needs.

This would be a valuable undertaking in the cases of all the proposed toolkits and in turn would increase their flexibility for other uses. Therefore, an online forum where all of the code fragments could be exchanged easily (along with tutorials) would assist in extending the dissemination of the tools and, as a consequence, pushing their further development and improvement. We expect

that such an implementation will also lower the participation barrier and allow others to take up these challenges, apply these tools in other contexts, and thus, help us develop our tools further. The same applies for the hardware components we utilized. A forum or wiki could act as storage for both soft- & hardware components and provide designers, artists, engineers and researchers with a common platform to improve their design and prototyping work in difficult contexts.

9.6 Closing Remarks

Over the course of this thesis, we presented our experiences with process extensions for prototyping tangible and intangible interactions in projects with industrial partners. By providing our lessons learned, we aim to inspire others who are interested in taking up our approach and enhance the design process of interactive systems in this domain. Through repetitive dissemination of the gathered findings, entire shelves of toolkits can emerge that can be further substantiated individually and improved with the help of the community. Doing so, we aim to help designers in various contexts, which in turn empowers them to create more usable and enjoyable systems and, get a step closer to Weiser's vision of *creating machines that fit the human environment* (Weiser, M., 1991).

Bibliography

- Adamczyk, P., Twidale, M.B., 2007. Supporting Multidisciplinary Collaboration: Requirements for Novel HCI Education., in: Proceeding of the Annual SIGCHI Conference on Human Factors in Computing Systems, CHI '07. ACM, New York, NY, USA, pp. 1073-1076
- Akaoka, E., Ginn, T., Vertegaal, R., 2010. DisplayObjects: Prototyping Functional Physical Interfaces on 3D Styrofoam, Paper or Cardboard Models, in: Proceedings of the International Conference on Tangible, Embedded, and Embodied Interaction, TEI '10. ACM Press, New York, NY, USA, pp. 235–238.
- Avrahami, D., Hudson, S.E., 2002. Forming interactivity: a tool for rapid prototyping of physical interactive products, in: Proceedings of the Biennial Conference on Designing Interactive Systems, DIS '02. ACM Press, New York, NY, USA, pp. 141–146.
- Bailey, B.P., Konstan, J.A., Carlis, J.V., 2001. DEMAIS: designing multimedia applications with interactive storyboards, in: Proceedings of the International Conference on Multimedia. ACM Press, New York, NY, USA, pp. 241–250.
- Ballagas, R., Ringel, M., Stone, M., Borchers, J., 2003. iStuff: a physical user interface toolkit for ubiquitous computing environments, in: Proceedings of the SIGCHI Conference on Human Factors in Computing Systems, CHI '03. ACM Press, New York, NY, USA, pp. 537–544.
- Bargas-Avila, J.A., Hornbaek, K., 2011. Old wine in new bottles or novel challenges: a critical analysis of empirical studies of user experience, in: Proceedings of the Annual Conference on Human Factors in Computing Systems., CHI '11. ACM Press, New York, NY, USA, pp. 2689–2698.
- Barkhuus, L., Rode, J., 2007. From mice to men. 24 years of evaluation in CHI, in: Extended Abstracts on Human Factors in Computing Systems, CHI '07. ACM Press, New York, NY, USA,

- Beaudouin-Lafon, M., Mackay, W., 2011. Prototyping Tools and Techniques, in: Prototype Development and Tools. Université Paris-Sud Press, France.
- Beyer, H., Holtzblatt, K., 1999. Contextual design, in: Interactions. ACM Press, New York, NY, USA, pp. 32–42.
- Biederman, I., 1987. Recognition-by-components: A theory of human image understanding., in: Psychological Review. American Psychological Association, p. 115.
- Bitner, M.J., Ostrom, A.L., Morgan, F.N., 2008. Service Blueprinting, in: California Management Review. University of California Press, pp. 66–95.
- Blackwell, A.F., Edge, D., 2009. Articulating tangible interfaces, in: Proceedings of the International Conference on Tangible and Embedded Interaction, TEI '09. ACM Press, New York, NY, USA, pp. 113–118.
- Bolt, R.A., 1980. “Put-that-there”: Voice and gesture at the graphics interface, in: ACM Siggraph Computer Graphics. ACM Press, New York, NY, USA, pp. 262–270.
- Boring, S., Baur, D., Butz, A., Gustafson, S., Baudisch, P., 2010. Touch projector: mobile interaction through video, in: Proceedings of the International Conference on Human Factors in Computing Systems, CHI '10. ACM Press, New York, NY, USA, pp. 2287–2296.
- Boring, S., Gehring, S., Wiethoff, A., Blöckner, M., Schöning, J., Butz, A., 2011. Multi-user interaction on media facades through live video on mobile devices, in: Proceedings of the Annual Conference on Human Factors in Computing Systems, CHI '11. ACM Press, New York, NY, USA, pp. 2721–2724.
- Brandt, E., Grunnet, C., 2000. Evoking the future: Drama and props in user centered design, in: Proceedings of International Participatory Design Conference, PDC '00. ACM Press, New York, NY, USA, pp. 11–20.
- Brandt, E., Messeter, J., 2004. Facilitating collaboration through design games, in: Proceedings of the International Conference on Participatory Design, PDC '04. ACM Press, New York, NY, USA, pp. 121–131.
- Brignull, H., Rogers, Y., 2003. Enticing people to interact with large public displays in public spaces, in: Proceedings of INTERACT. Springer London, pp. 17–24.

- Buchenau, M., Suri, J.F., 2000. Experience prototyping, in: Proceedings of the Biennial Conference on Designing Interactive Systems, DIS '00. ACM Press, New York, NY, USA, pp. 424–433.
- Buechley, L., Eisenberg, M., Catchen, J., Crockett, A., 2008. The LilyPad Arduino: using computational textiles to investigate engagement, aesthetics, and diversity in computer science education, in: Proceeding of the Annual SIGCHI Conference on Human Factors in Computing Systems, CHI '08. ACM Press, New York, NY, USA, pp. 423–432.
- Buechley, L., Hill, B.M., 2010. LilyPad in the wild: how hardware's long tail is supporting new engineering and design communities, in: Proceedings of the Biennial Conference on Designing Interactive Systems, DIS '10. ACM Press, New York, NY, USA, pp. 199–207.
- Burmester, M., Mast, M., Jäger, K., Homans, H., 2010. Valence method for formative evaluation of user experience, in: Proceedings of the Biennial Conference on Designing Interactive Systems, DIS '10. ACM Press, New York, NY, USA, pp. 364–367.
- Buxton, B., 2007. Sketching User Experiences: Getting the Design Right and the Right Design. Morgan Kaufmann.
- Buxton, W., 1986. Chunking and phrasing and the design of human-computer dialogues, in: Proceedings of the IFIP World Computer Congress. University of Toronto Press, pp. 475–480.
- Carroll, J.M., 1995. Scenario-based design: envisioning work and technology in system development. John Wiley and Sons.
- Carroll, J.M., 2000. Five reasons for scenario-based design, in: Interacting with Computers. Elsevier, pp. 43–60.
- Chandler, C.D., Lo, G., Sinha, A.K., 2002. Multimodal theater: Extending low fidelity paper prototyping to multimodal applications, in: Extended Abstracts on Human Factors in Computing Systems, CHI '02. ACM Press, New York, NY, USA, pp. 874–875.
- Cheng, K.Y., Liang, R.H., Chen, B.Y., Laing, R.H., Kuo, S.Y., 2010. iCon: utilizing everyday objects as additional, auxiliary and instant tabletop controllers, in: Proceedings of the International Conference on Human Factors in Computing Systems, CHI '10. ACM Press, New York, NY, USA, pp. 1155–1164.

- Corbin, J., Strauss, A., 2008. *Basics of Qualitative Research: Techniques and Procedures for Developing Grounded Theory*, Third. ed. Sage Publications.
- Crampton Smith, G., 1995. The hand that rocks the cradle. *ID Magazine*, pp. 60–65.
- Dahlbäck, N., Jönsson, A., Ahrenberg, L., 1993. Wizard of Oz studies — why and how, in: *Knowledge-Based Systems*. Elsevier, pp. 258–266.
- Dalsgaard, P., Halskov, K., 2010. Designing urban media façades: cases and challenges, in: *Proceedings of the International Conference on Human Factors in Computing Systems, CHI '10*. ACM Press, New York, NY, USA, pp. 2277–2286.
- de la Barré, R., Chojecki, P., Leiner, U., Mühlbach, L., Ruschin, D., 2009. Touchless Interaction—Novel Chances and Challenges, in: *Human-Computer Interaction. Novel Interaction Methods and Techniques*. Springer London, pp. 161–169.
- Dietz, P.H., Eidelson, B.D., 2009. SurfaceWare: dynamic tagging for Microsoft Surface, in: *Proceedings of the International Conference on Tangible and Embedded Interaction, TEI '09*. ACM Press, New York, NY, USA, pp. 249–254.
- Dix, A., 2004. *Human-computer interaction*. Pearson Education.
- Echtler, F., 2009. *Tangible Information Displays*. Technical University of Munich (Ph.D Thesis)
- Eisenberg, M., 2002. Output devices, computation, and the future of mathematical crafts, in: *International Journal of Computers for Mathematical Learning*. Kluwer Academic Publishers, pp. 1–44.
- Eisenberg, M., Eisenberg, A., Hendrix, S., Blauvelt, G., Butter, D., Garcia, J., Lewis, R., Nielsen, T., 2003. As we may print: new directions in output devices and computational crafts for children, in: *Proceedings of the Conference on Interaction Design and Children, IDC '03*. ACM Press, New York, NY, USA, pp. 31–39.
- Engelbart, D., 2001. *Augmenting human intellect: a conceptual framework (1962)*. PACKER, Randall and JORDAN, Ken. *Multimedia. From Wagner to Virtual Reality*. New York: WW Norton & Company 64–90.

-
- Engelbart, D.C., English, W.K., 1968. A research center for augmenting human intellect, in: Proceedings of the December 9-11, 1968, Fall Joint Computer Conference, Part I. pp. 395–410.
- Erickson, T., 1995. Notes on design practice: Stories and prototypes as catalysts for communication, in: Scenario-based Design: Envisioning Work and Technology in System Development. John Wiley & Sons, pp. 37–58.
- Fallman, D., 2003. Design-oriented human-computer interaction, in: Proceedings of the SIGCHI Conference on Human Factors in Computing Systems, CHI '03. ACM Press, New York, NY, USA, pp. 225–232.
- Feiner, S., Shamash, A., 1991. Hybrid user interfaces: Breeding virtually bigger interfaces for physically smaller computers, in: Proceedings of the Annual ACM Symposium on User Interface Software and Technology, UIST '91. ACM Press, New York, NY, USA, pp. 9–17.
- Fitzmaurice, G.W., 1996. Graspable user interfaces. University of Toronto.
- Fitzmaurice, G.W., Ishii, H., Buxton, W.A.S., 1995. Bricks: laying the foundations for graspable user interfaces, in: Proceedings of the SIGCHI Conference on Human Factors in Computing Systems, CHI '95. ACM Press, New York, NY, USA, pp. 442–449.
- Forlizzi, J., Battarbee, K., 2004. Understanding experience in interactive systems, in: Proceedings of the Biennial Conference on Designing Interactive Systems, DIS '04. ACM Press, New York, NY, USA, New York, NY, USA, pp. 261–268.
- Frayling, C., 1993. Research in art and design. Royal College of Art.
- Freeman, W.T., Weissman, C., 1995. Television control by hand gestures, in: Proc. of Intl. Workshop on Automatic Face and Gesture Recognition. IEEE Press, New Jersey, NJ, USA, pp. 179–183.
- Gaines, B.R., 1991. Modeling and forecasting the information sciences. *Information Sciences* 57, 3–22.

- Geven, A., Schrammel, J., Tscheligi, M., 2006. Narrations and storytelling as methodological key elements for studying user experience, in: Proceedings of the Nordic Conference on Human-computer Interaction, NordiCHI '06. ACM Press, New York, NY, USA, pp. 79–83.
- Goffman, E., 1966. Behavior in public places: Notes on the social organization of gatherings. Free Press.
- Greenberg, S., Buxton, W., 2007. Usability evaluation considered harmful, in: Proceedings of the International Conference on Human Factors in Computing Systems, CHI '07. ACM Press, New York, NY, USA, pp. 111-120.
- Greenberg, S., 2006. Toolkits and interface creativity, in: Multimedia Tools and Applications. Springer London, pp. 139–159.
- Greenberg, S., Fitchett, C., 2001. Phidgets: easy development of physical interfaces through physical widgets, in: Proceedings of the Annual ACM Symposium on User Interface Software and Technology, UIST '01. ACM Press, New York, NY, USA, pp. 209–218.
- Halskov, K., Dalsgaard, P., 2006. Inspiration card workshops, in: Proceedings of the Biennial Conference on Designing Interactive Systems, DIS '06. ACM Press, New York, NY, USA, pp. 2–11.
- Halskov, K., Nielsen, R., 2006. Virtual video prototyping, in: Human-Computer Interaction. Lawrence Erlbaum, pp. 199–233.
- Hassenzahl, M., 2010. Experience Design: Technology for all the right reasons, in: Synthesis Lectures on Human-Centered Informatics. Morgan & Claypool, pp. 1–95.
- Hassenzahl, M., Diefenbach, S., Göritz, A., 2010. Needs, affect, and interactive products—Facets of user experience, in: Interacting with Computers. Elsevier, pp. 353–362.
- Hassenzahl, M., Tractinsky, N., 2006. User experience - a research agenda, in: Behaviour & Information Technology. Taylor & Francis, pp. 91–97.
- Hilliges, O., Baur, D., Butz, A., 2007. Photohelix: Browsing, sorting and sharing digital photo collections, in: Annual International Workshop on Horizontal Interactive Human-Computer Systems, TABLETOP '07. Springer London, pp. 87–94.

-
- Hilliges, O., Izadi, S., Wilson, A.D., Hodges, S., Garcia-Mendoza, A., Butz, A., 2009. Interactions in the air: adding further depth to interactive tabletops, in: Proceedings of the Annual ACM Symposium on User Interface Software and Technology, UIST'09. ACM Press, New York, NY, USA, pp. 139–148.
- Hinckley, K., Pausch, R., Goble, J.C., Kassell, N.F., 1994. A survey of design issues in spatial input, in: Proceedings of the Annual ACM Symposium on User Interface Software and Technology, UIST '94. ACM Press, New York, NY, USA, pp. 213–222.
- Holmquist, L., Mattern, F., Schiele, B., Alahuhta, P., Beigl, M., Gellersen, H.W., 2001. Smart-its friends: A technique for users to easily establish connections between smart artifacts, in: Proceedings of the International Conference on Ubiquitous Computing, Ubicomp '01. ACM Press, New York, NY, USA, pp. 116–122.
- Holmquist, L.E., 2006. Sketching in hardware, in: Interactions. ACM Press, New York, NY, USA, pp. 47–60.
- Horn, M.S., Solovey, E.T., Jacob, R.J.K., 2008. Tangible programming and informal science learning: making TUIs work for museums, in: Proceedings of the International Conference on Interaction Design and Children, IDC '08. ACM, New York, NY, USA, pp. 194–201.
- Hornecker, E., 2012. Beyond Affordance: Tangibles' Hybrid Nature, in: Proceedings of the International Conference on Tangible and Embedded Interaction, TEI '12. ACM Press, New York, NY, USA, pp. 175–182.
- Hornecker, E., Burr, J., 2006. Getting a Grip on Tangible Interaction: A Framework on Physical Space and Social Interaction, in: Proceedings of the Annual Conference on Human Factors in Computing Systems, CHI '06. ACM Press, New York, NY, USA, pp. 437–446.
- Hornecker, E., Stifter, M., 2006. Learning from interactive museum installations about interaction design for public settings, in: Proceedings of the Australia Conference on Computer-Human Interaction, OzCHI '06. ACM Press, New York, NY, USA, pp. 135–142.
- Houde, S., Hill, C., 1997. What do prototypes prototype. Handbook of human-computer interaction 2, pp. 367–380.

- Ishii, H., 2008a. The tangible user interface and its evolution. Communications. ACM Press, New York, NY, USA, pp. 32–36.
- Ishii, H., 2008b. Tangible bits: beyond pixels, in: Proceedings of the International Conference on Tangible and Embedded Interaction, TEI '08. ACM Press, New York, NY, USA, pp. 15–25.
- Ishii, H., Ullmer, B., 1997. Tangible bits: towards seamless interfaces between people, bits and atoms, in: Proceedings of the SIGCHI Conference on Human Factors in Computing Systems, CHI '97. ACM Press, New York, NY, USA, pp. 234–241.
- Jones, J.C., 1992. Design Methods. John Wiley and Sons.
- Jordà, S., 2010. The reactable: tangible and tabletop music performance, in: Extended Abstracts on Human Factors in Computing Systems, CHI '10. ACM Press, New York, NY, USA, pp. 2989–2994.
- Kaltenbrunner, M., Bencina, R., 2007. reactIVision: a computer-vision framework for table-based tangible interaction, in: Proceedings of the 1st International Conference on Tangible and Embedded Interaction, TEI '07. ACM, New York, NY, USA, pp. 69–74.
- Kelley, T., Littman, J., 2005. The ten faces of innovation: IDEO's strategies for beating the devil's advocate & driving creativity throughout your organization. Crown Business.
- Kirk, D., Sellen, A., Taylor, S., Villar, N., Izadi, S., 2009. Putting the physical into the digital: issues in designing hybrid interactive surfaces, in: Proceedings of the British HCI Group Annual Conference on People and Computers. British Computer Society, pp. 35–44.
- Klemmer, S.R., Hartmann, B., Takayama, L., 2006. How bodies matter: five themes for interaction design, in: Proceedings of the Biennial Conference on Designing Interactive Systems, DIS '06. ACM Press, New York, NY, USA, pp. 140–149.
- Klemmer, S.R., Li, J., Lin, J., Landay, J.A., 2004. Papier-Mache: toolkit support for tangible input, in: Proceedings of the SIGCHI Conference on Human Factors in Computing Systems, CHI '04. ACM Press, New York, NY, USA, pp. 399–406.

- Klemmer, S.R., Sinha, A.K., Chen, J., Landay, J.A., Aboobaker, N., Wang, A., 2000. Suede: a Wizard of Oz prototyping tool for speech user interfaces, in: Proceedings of the Annual ACM Symposium on User Interface Software and Technology, UIST '00. ACM Press, New York, NY, USA, pp. 1–10.
- König, W., Rädle, R., Reiterer, H., 2010. Interactive design of multimodal user interfaces. *Journal on Multimodal User Interfaces* 3, 197–213.
- Korhonen, H., Arrasvuori, J., Väänänen-Vainio-Mattila, K., 2010. Let users tell the story: evaluating user experience with experience reports, in: Extended Abstracts on Human Factors in Computing Systems, CHI '10. ACM Press, New York, NY, USA, pp. 4051–4056.
- Kortbek, K.J., Grønåk, K., 2008. Interactive spatial multimedia for communication of art in the physical museum space, in: Proceeding of the ACM International Conference on Multimedia. ACM Press, New York, NY, USA, pp. 609–618.
- Kotonya, G., Sommerville, I., 1998. Requirements Engineering: Processes and Techniques, 1st ed. Wiley.
- Kratz, S., Westermann, T., Rohs, M., Essl, G., 2011. CapWidgets: tangible widgets versus multi-touch controls on mobile devices, in: Extended Abstracts on Human Factors in Computing Systems, CHI '11. ACM Press, New York, NY, USA, pp. 1351–1356.
- Krueger, M.W., Gionfriddo, T., Hinrichsen, K., 1985. VIDEOPLACE—an artificial reality. ACM Press, New York, NY, USA, pp. 35–40.
- Lazar, J., Feng, J.H., Hochheiser, H., 2009. Research Methods in Human-Computer Interaction. John Wiley & Sons.
- Lee, J., Ishii, H., 2010. Beyond: collapsible tools and gestures for computational design, in: Extended Abstracts on Human Factors in Computing Systems, CHI '10. ACM Press, New York, NY, USA, pp. 3931–3936.
- Leithinger, D., Lakatos, D., DeVincenzi, A., Blackshaw, M., 2011. Recompose, in: Interactions. ACM Press, New York, NY, USA, p. 8.
- Lewis, J.R., 1991. Psychometric evaluation of an after-scenario questionnaire for computer usability studies: the ASQ, in: SIGCHI Bull. ACM Press, New York, NY, USA, pp. 78–81.

- Lim, Y.-K., Stolterman, E., Tenenber, J., 2008. The anatomy of prototypes, in: *Transactions on Computer-Human Interaction*. ACM Press, New York, NY, USA, pp. 1–27.
- Löwgren, J., 1995. Applying design methodology to software development, in: *Proceedings of the Biennial Conference on Designing Interactive Systems, DIS '95*. ACM Press, New York, NY, USA, pp. 87–95.
- Löwgren, J., 2004. Animated use sketches as design representations, in: *Interactions*. ACM Press, New York, NY, USA, pp. 22–27.
- Maguire, M., 2001. Methods to support Human Centered Design, in: *International Journal of Human-Computer Studies*. Academic Press, pp. 587–634.
- Margolin, V., Buchanan, R., 1995. *The idea of design*. MIT Press.
- Martin, R.C., 2003. *Agile software development: principles, patterns, and practices*. Prentice Hall.
- McCurdy, M., Connors, C., Pyrzak, G., Kanefsky, B., Vera, A., 2006. Breaking the fidelity barrier: an examination of our current characterization of prototypes and an example of a mixed-fidelity success, in: *Proceedings of the SIGCHI Conference on Human Factors in Computing Systems, CHI '06*. ACM Press, New York, NY, USA, pp. 1233–1242.
- Mellis, D., Banzi, M., Cuartielles, D., Igoe, T., 2007. Arduino: An open electronic prototyping platform, in: *Extended Abstracts of the Annual Conference on Human Factors in Computing Systems, CHI '07*. ACM Press, New York, NY, USA.
- Mignonneau, L., Sommerer, C., 2008. Media Facades as Architectural Interfaces, in: *The Art and Science of Interface and Interaction Design*. Springer London, pp. 93–104.
- Miyaoku, K., Higashino, S., Tonomura, Y., 2004. C-blink: a hue-difference-based light signal marker for large screen interaction via any mobile terminal, in: *Proceedings of the Annual ACM Symposium on User Interface Software and Technology, UIST '04*. ACM Press, New York, NY, USA, pp. 147–156.
- Moggridge, B., 2006. *Designing Interactions*. MIT Press.
- Moussette, C., Dore, F., 2010. *Sketching in Hardware and Building Interaction Design: tools, toolkits and an attitude for Interaction Designers*. Design Research Society.

- Muller, M.J., 1991. PICTIVE—an exploration in participatory design, in: Proceedings of the SIGCHI Conference on Human Factors in Computing Systems, CHI '91. ACM Press, New York, NY, USA, pp. 225–231.
- Muller, M.J., Kuhn, S., 1993. Participatory design, in: Communications. ACM Press, New York, NY, USA, pp. 24–28.
- Nielsen, J., 1992. The usability engineering life cycle, in: Computer. IEEE Press, New Jersey, NJ, USA, pp. 12–22.
- Norman, D.A., 1999. Affordance, conventions, and design, in: Interactions. ACM Press, New York, NY, USA, pp. 38–43.
- Olsen, Jr., D.R., Nielsen, T., 2001. Laser pointer interaction, in: Proceedings of the SIGCHI Conference on Human Factors in Computing Systems, CHI '01. ACM Press, New York, NY, USA, pp. 17–22.
- Oulasvirta, A., Kurvinen, E., Kankainen, T., 2003. Understanding contexts by being there: case studies in bodystorming, in: Personal and Ubiquitous Computing. Springer London, pp. 125–134.
- Pasupathi, M., McLean, K.C., Weeks, T., 2009. To Tell or Not to Tell: Disclosure and the Narrative Self, in: Journal of Personality. Wiley, pp. 89–124.
- Patten, J., Recht, B., Ishii, H., 2002. Audiopad: a tag-based interface for musical performance, in: Proceedings of the Conference on New Interfaces for Musical Expression, NIME '02. ACM Press, New York, NY, USA, pp. 1–6.
- Patten, J., Recht, B., Ishii, H., 2006. Interaction techniques for musical performance with tabletop tangible interfaces, in: Proceedings of the SIGCHI International Conference on Advances in Computer Entertainment Technology. ACM Press, New York, NY, USA, p. 27–es.
- Peltonen, P., Kurvinen, E., Salovaara, A., Jacucci, G., Ilmonen, T., Evans, J., Oulasvirta, A., Saarikko, P., 2008. It's Mine, Don't Touch!: interactions at a large multi-touch display in a city centre, in: Proceedings of the Annual SIGCHI Conference on Human Factors in Computing Systems, CHI '08. ACM Press, New York, NY, USA, pp. 1285–1294.
- Polya, G., 2004. How to Solve It: A New Aspect of Mathematical Method. Princeton University Press.

- Reed, M., 2009. Prototyping digital clay as an active material, in: Proceedings of the International Conference on Tangible and Embedded Interaction, TEI '09. ACM Press, New York, NY, USA, pp. 339–342.
- Rekimoto, J., Saitoh, M., 1999. Augmented surfaces: a spatially continuous work space for hybrid computing environments, in: Proceedings of the SIGCHI Conference on Human Factors in Computing Systems. CHI '99, pp. 378–385.
- Rekimoto, J., Ullmer, B., Oba, H., 2001. DataTiles: a modular platform for mixed physical and graphical interactions, in: Proceedings of the SIGCHI Conference on Human Factors in Computing Systems. CHI '01, pp. 269–276.
- Rettig, M., 1994. Prototyping for tiny fingers. *Communications of the ACM* 37, 21–27.
- Reynolds, T.J., Gutman, J., 1988. Laddering theory, method, analysis, and interpretation. *Journal of advertising research* 28, 11–31.
- Rittel, H.W.J., Webber, M.M., 1984. Planning problems are wicked problems. *Developments in design methodology* 135–144.
- Rudd, J., Stern, K., Isensee, S., 1996. Low vs. high-fidelity prototyping debate, in: *Interactions*. ACM Press, New York, NY, USA, pp. 76–85.
- Ryu, D., Um, D., Tanofsky, P., Koh, D.H., Ryu, Y.S., Kang, S., 2010. T-less : A novel touch-less human-machine interface based on infrared proximity sensing, in: Proceedings of the International Conference on Intelligent Robots and Systems. IEEE Press, New Jersey, NJ, USA, pp. 5220 –5225.
- Saffer, D., 2008. *Designing Gestural Interfaces: Touchscreens and Interactive Devices*, 1st ed. O'Reilly Media.
- Saffer, D., 2009. *Designing for Interaction: Creating Innovative Applications and Devices*, Second ed. New Riders.
- Sanders, E.B.N., Brandt, E., Binder, T., 2010. A framework for organizing the tools and techniques of participatory design, in: Proceedings of the Biennial Participatory Design Conference, PDC '10. ACM Press, New York, NY, USA, pp. 195–198.
- Sanders, L., 2008. An evolving map of design practice and design research, in: *Interactions*. ACM Press, New York, NY, USA, pp. 13–17.

-
- Schön, D.A., 1983. *The reflective practitioner: How professionals think in action*. Basic books.
- Schön, D.A., 1987. *Educating the reflective practitioner*. Jossey-Bass.
- Schön, D.A., 1992. Designing as reflective conversation with the materials of a design situation. *Knowledge-Based Systems* 5, 3–14.
- Sefelin, R., Tscheligi, M., Giller, V., 2003. Paper prototyping-what is it good for?: a comparison of paper-and computer-based low-fidelity prototyping, in: *Extended Abstracts on Human Factors in Computing Systems, CHI '03*. ACM Press, New York, NY, USA, pp. 778–779.
- Seitinger, S., Perry, D.S., Mitchell, W.J., 2009. Urban pixels: painting the city with light, in: *Proceedings of the International Conference on Human Factors in Computing Systems, CHI '09*. ACM Press, New York, NY, USA, pp. 839–848.
- Shaer, O., Hornecker, E., 2010. *Tangible User Interfaces*. Now Publishers Inc.
- Sharp, H., Rogers, Y., Preece, J., 2007. *Interaction Design: Beyond Human-Computer Interaction*, Second ed. John Wiley & Sons.
- Sheldon, K.M., Elliot, A.J., Kim, Y., Kasser, T., 2001. What is satisfying about satisfying events? Testing 10 candidate psychological needs. *Journal of personality and social psychology*, pp. 325–339.
- Shneiderman, B., 2000. Creating creativity: user interfaces for supporting innovation, in: *Transactions on Computer-Human Interaction, TOCHI*. ACM Press, New York, NY, USA, pp. 114–138.
- Shoemaker, G., Tang, A., Booth, K.S., 2007. Shadow reaching: a new perspective on interaction for large displays, in: *Proceedings of the Annual ACM Symposium on User Interface Software and Technology, UIST '07*. ACM Press, New York, NY, USA, pp. 53–56.
- Smith, J., White, T., Dodge, C., Allport, D., Paradiso, J., Gershenfeld, N., 1998. Electric Field Sensing for Graphical Interfaces, in: *IEEE Computer Graphics and Applications*. IEEE Press, New Jersey, NJ, USA.
- Smith-Atakan, S., 2006. *The FastTrack to Human-Computer Interaction*, 1st ed. Thomson Learning.

- Snyder, C., 2003. Paper Prototyping: The Fast and Easy Way to Design and Refine User Interfaces. Morgan Kaufmann.
- Standardization, I.-I.O. for, 2012. ISO - International Organization for Standardization. http://www.iso.org/iso/catalogue_detail.htm?csnumber=52075
- Streitz, N.A., Geissler, J., Holmer, T., Konomi, S., Müller-Tomfelde, C., Reischl, W., Rexroth, P., Seitz, P., Steinmetz, R., 1999. i-LAND: an interactive landscape for creativity and innovation, in: Proceedings of the SIGCHI Conference on Human Factors in Computing Systems, CHI '99. ACM Press, New York, NY, USA, pp. 120–127.
- Sutherland, I.E., 1964. Sketch pad a man-machine graphical communication system, in: Proceedings of the SHARE Design Automation Workshop. ACM Press, New York, NY, USA, pp. 6–329.
- Svanaes, D., Seland, G., 2004. Putting the users center stage: role playing and low-fi prototyping enable end users to design mobile systems, in: Proceedings of the SIGCHI Conference on Human Factors in Computing Systems, CHI '04. ACM Press, New York, NY, USA, pp. 479–486.
- Taxén, G., 2004. Introducing participatory design in museums, in: Proceedings of the Conference on Participatory Design, PDC '04. ACM Press, New York, NY, USA, pp. 204–213.
- Tohidi, M., Buxton, W., Baecker, R., Sellen, A., 2006a. Getting the right design and the design right, in: Proceedings of the SIGCHI Conference on Human Factors in Computing Systems, CHI '06. ACM Press, New York, NY, USA, pp. 1243–1252.
- Tohidi, M., Buxton, W., Baecker, R., Sellen, A., 2006b. User sketches: a quick, inexpensive, and effective way to elicit more reflective user feedback, in: Proceedings of the Nordic Conference on Human-computer Interaction: Changing Roles, NordiCHI '06. ACM Press, New York, NY, USA, pp. 105–114.

- Ullmer, B., Dell, C., Gil, C., Toole Jr, C., Wiley, C., Dever, Z., Rogge, L., Bradford, R., Riviere, G., Sankaran, R., others, 2011. Casier: structures for composing tangibles and complementary interactors for use across diverse systems, in: Proceedings of the International Conference on Tangible, Embedded, and Embodied Interaction, TEI '11. ACM Press, New York, NY, USA, pp. 229–236.
- Ullmer, B., Dever, Z., Sankaran, R., Toole Jr, C., Freeman, C., Cassady, B., Wiley, C., Diabi, M., Wallace Jr, A., DeLatin, M., others, 2010. Cartouche: conventions for tangibles bridging diverse interactive systems, in: Proceedings of the International Conference on Tangible, Embedded, and Embodied Interaction, TEI '10. ACM Press, New York, NY, USA, pp. 93–100.
- Ullmer, B., Ishii, H., 1997. The metaDESK: models and prototypes for tangible user interfaces, in: Proceedings of the Annual ACM Symposium on User Interface Software and Technology, UIST '97. ACM Press, New York, NY, USA, pp. 223–232.
- Underkoffler, J., Ishii, H., 1998. Illuminating Light: An Optical Design Tool with a Luminous-Tangible Interface, in: Proceedings of the International Conference on Human Factors in Computing Systems, CHI '98. ACM Press, New York, NY, USA, pp. 542–549.
- Underkoffler, J., Ishii, H., 1999. Urp: a luminous-tangible workbench for urban planning and design, in: Proceedings of the SIGCHI Conference on Human Factors in Computing Systems, CHI '99. ACM Press, New York, NY, USA, pp. 386–393.
- van den Hoven, E., Frens, J., Aliakseyeu, D., Martens, J.B., Overbeeke, K., Peters, P., 2007. Design Research & Tangible Interaction, in: Proceedings of the International Conference on Tangible, Embedded, and Embodied Interaction, TEI '07. ACM Press, New York, NY, USA, pp. 109–115.
- Vogel, D., Balakrishnan, R., 2005. Distant freehand pointing and clicking on very large, high resolution displays, in: Proceedings of the Annual ACM Symposium on User Interface Software and Technology, UIST '05. ACM Press, New York, NY, USA, pp. 33–42.

- Vredenburg, K., Mao, J.Y., Smith, P.W., Carey, T., 2002. A survey of user-centered design practice, in: Proceedings of the SIGCHI Conference on Human Factors in Computing Systems, CHI '02. ACM Press, New York, NY, USA, pp. 471–478.
- Wahid, S., McCrickard, D.S., DeGol, J., Elias, N., Harrison, S., 2011. Don't drop it!: pick it up and storyboard, in: Proceedings of the Annual Conference on Human Factors in Computing Systems., CHI '11. ACM Press, New York, NY, USA, pp. 1571–1580.
- Wakkary, R., Hatala, M., 2006. ec (h) o: Situated Play in a Tangible and Audio Museum Guide, in: Proceedings of the Biennial Conference on Designing Interactive Systems, DIS '06. ACM Press, New York, NY, USA, pp. 281–290.
- Watson, D., Clark, L.A., Tellegen, A., 1988. Development and validation of brief measures of positive and negative affect: the PANAS scales. *Journal of personality and social psychology* 54, pp. 1063-1070.
- Weiser, M., 1991. The Computer for the 21st Century. *Scientific American*, 256, pp. 94-104.
- Weiser, M., Brown, J.S., 1996. Designing calm technology. *PowerGrid Journal* 1, pp. 75–85.
- Wiethoff, A., Blöckner, M., 2011. LightBox: exploring interaction modalities with colored light, in: Proceedings of the International Conference on Tangible, Embedded, and Embodied Interaction, TEI '11. ACM Press, New York, NY, USA, pp. 399–400.
- Wiethoff, A., Butz, A., 2010. Process Tools for Interaction Design, in: *International Reports on Socio-Informatics*. Institute for Socio-Informatics, pp. 17–22.
- Wiethoff, A., Gehring, S., 2011. Interacting with Light, in: *Workshop Proceedings of the European Symposium on Ambient Intelligence*, AMI '11. Springer London
- Wiethoff, A., Gehring, S., 2012. Designing interaction with media façades: A case study, in: Proceedings of the Biennial Conference on Designing Interactive Systems, DIS '12. ACM Press, New York, NY, USA, p. 308-317.

-
- Wiethoff, A., Kowalski, R., Butz, A., 2011. inTUIt: simple identification on tangible user interfaces, in: Proceedings of the International Conference on Tangible, Embedded, and Embodied Interaction, TEI '11. ACM Press, New York, NY, USA, pp. 201–204.
- Wiethoff, A., Richter, H., 2011. Hybrid Interactions on in-car touch interfaces, in: Workshop Proceedings on Natural Car Interfaces, Automotive UI '11, Springer London.
- Wiethoff, A., Schneider, H., Rohs, M., Butz, A., Greenberg, S., 2012. Sketch-a-TUI: low cost prototyping of tangible interactions using cardboard and conductive ink, in: Proceedings of the International Conference on Tangible, Embedded and Embodied Interaction, TEI '12. ACM Press, New York, NY, USA, pp. 309–312.
- Wiethoff, A., Wimmer, R., Richter, H., Butz, A., 2010. Different brainstorming methods within the context of physical computing, in: Proceedings of the International Conference on Technology for Education, T4E '10. IEEE Press, New Jersey, NJ, USA, pp. 47-49.
- Wimmer, R., Holleis, P., Kranz, M., Schmidt, A., 2006. Thracker -using capacitive sensing for gesture recognition, in: Proceedings of the International Conference on Distributed Computing Systems, ICDCS Workshops. IEEE Press, New Jersey, NJ, USA, pp. 64–64.
- Wobbrock, J.O., Aung, H.H., Rothrock, B., Myers, B.A., 2005. Maximizing the guessability of symbolic input, in: Extended Abstracts on Human Factors in Computing Systems, CHI '05, ACM Press, New York, NY, USA pp. 1869–1872.
- Wolf, T.V., Rode, J.A., Sussman, J., Kellogg, W.A., 2006. Dispelling design as the black art of CHI, in: Proceedings of the SIGCHI Conference on Human Factors in Computing Systems, CHI '06. ACM Press, New York, NY, USA, pp. 521–530.
- Wong, Y.Y., 1992. Rough and ready prototypes: Lessons from graphic design, in: Posters and Short Talks of the SIGCHI Conference on Human Factors in Computing Systems, CHI '92. ACM Press, New York, NY, USA, pp. 83–84.

- Wright, P., McCarthy, J., 2008. Empathy and experience in HCI, in: Proceedings of the Annual SIGCHI Conference on Human Factors in Computing Systems, CHI '08. ACM Press, New York, NY, USA, pp. 637–646.
- Yu, N.-H., Chan, L.-W., Lau, S.Y., Tsai, S.-S., Hsiao, I.-C., Tsai, D.-J., Hsiao, F.-I., Cheng, L.-P., Chen, M., Huang, P., Hung, Y.-P., 2011. TUIC: enabling tangible interaction on capacitive multi-touch displays, in: Proceedings of the Annual Conference on Human Factors in Computing Systems, CHI '11. ACM Press, New York, NY, USA, pp. 2995–3004.
- Zimmerman, J., Forlizzi, J., Evenson, S., 2007. Research through design as a method for interaction design research in HCI, in: Proceedings of the SIGCHI Conference on Human Factors in Computing Systems, CHI '07. ACM Press, New York, NY, USA, pp. 493–502.